

VTC 2k Color

User Manual

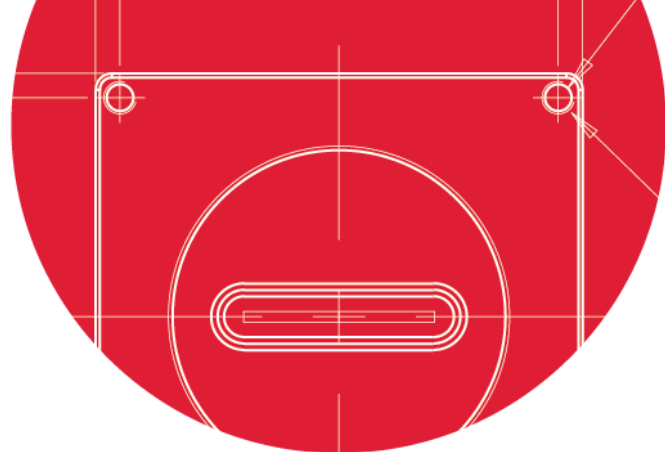

English

VTC-2K10.5G-C19A-80

GIG[®]
VISION

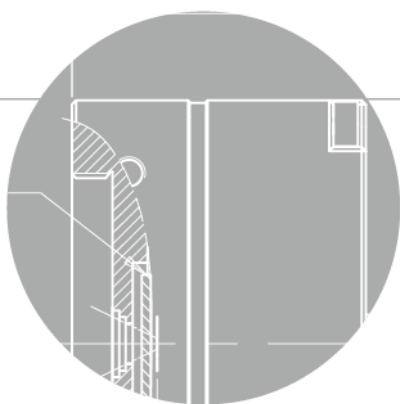

VIEWWORKS

Revision History

Version	Date	Description
1.0	2018-09-05	Initial Release
1.1	2019-08-14	<ul style="list-style-type: none">Revised the Quantum Efficiency graphAdded the Frame Start Trigger feature
1.2	2021-01-21	<ul style="list-style-type: none">Applied new CIAdded the recommended Ethernet Adapter specificationRevised the model nameRevised camera mechanical dimensions
1.3	2021-03-19	Corrected the orientation of the 6-pin connector in the user manual
	2021-09-24	Deleted the "Exposure Control" text in the "Main Features"

Contents

1	Precautions	6
2	Warranty	8
3	Compliance & Certifications	8
3.1	FCC Compliance.....	8
3.2	CE: DoC	8
3.3	KC	8
4	Package Components	9
5	Product Specifications	10
5.1	Overview.....	10
5.2	Specifications.....	11
5.3	Camera Block Diagram	12
5.4	Spectral Response.....	13
5.5	Mechanical Specification.....	14
5.5.1	Camera Mounting and Heat Dissipation.....	14
6	Software Licensing Information	15
7	Connecting the Camera	16
7.1	Precaution to Center the Image Sensor	16
7.2	Installing Vieworks Imaging Solution	16
8	Camera Interface	17
8.1	General Description	17
8.2	RJ-45 Jack.....	18
8.3	Power Input Receptacle	19
8.4	Control I/O Receptacle.....	20
8.5	Trigger Input Circuit.....	21
8.6	Strobe Output Circuit	21
9	Acquisition Control	22
9.1	Acquisition Start/Stop Commands and Acquisition Mode	22
9.2	Frame Start Trigger.....	23
9.2.1	Trigger Mode (Frame Start) = Off	23
9.2.2	Trigger Mode (Frame Start) = On	24

9.3	Line Start Trigger	25
9.3.1	Trigger Mode (Line Start) = Off.....	25
9.3.2	Trigger Mode (Line Start) = On.....	27
9.3.3	Using an External Trigger Signal.....	28
9.3.4	Use Case	29
9.3.5	Trigger Rescaler Mode	32
9.3.6	Trigger Statistics	33
9.4	Maximum Allowed Line Rate	34
9.4.1	Increasing the Maximum Allowed Line Rate	34
10	Camera Features.....	35
10.1	Operation Mode.....	35
10.2	TDI Stages	36
10.3	Scan Direction.....	37
10.4	Region of Interest.....	38
10.4.1	Setting the ROI	39
10.4.2	Setting the Height	39
10.5	Pixel Format.....	40
10.6	Inter-Packet Delay.....	41
10.7	Gain and Black Level.....	42
10.8	White Balance	43
10.9	Color Transformation.....	44
10.10	LUT	46
10.11	Dark Signal Non-uniformity Correction	48
10.11.1	Generating and Saving User DSNU Correction Values	49
10.12	Photo Response Non-uniformity Correction.....	51
10.12.1	Generating and Saving User PRNU Correction Values	52
10.13	Reverse X	53
10.14	Strobe Mode.....	54
10.15	Device User ID	55
10.16	Device Reset.....	55
10.17	Temperature Monitor	56
10.18	Status LED	56
10.19	Test Pattern	57
10.20	User Set Control.....	59
10.20.1	Factory Default Setting Values	61
10.21	Field Upgrade.....	61

11 Troubleshooting.....	62
Appendix A Field Upgrade.....	63
A.1 MCU / FPGA / XML.....	63
Appendix B LUT Download	65
B.1 Gamma Graph Download	65
B.2 CSV File Download.....	67
Appendix C Correction Control.....	69
C.1 Adjusting and Saving Additional DSNU Correction Value	70
C.2 Adjusting and Saving Additional PRNU Correction Value	71

1 Precautions

General



- Do not drop, disassemble, repair or alter the device. Doing so may damage the camera electronics and cause an electric shock.
- Do not let children touch the device without supervision.
- Stop using the device and contact the nearest dealer or manufacturer for technical assistance if liquid such as water, drinks or chemicals gets into the device.
- Do not touch the device with wet hands. Doing so may cause an electric shock.
- Make sure that the temperature of the camera does not exceed the temperature range specified in [5.2 Specifications](#). Otherwise the device may be damaged by extreme temperatures.

Installation and Maintenance



- Do not install in dusty or dirty areas – or near an air conditioner or heater to reduce the risk of damage to the device.
- Avoid installing and operating in an extreme environment where vibration, heat, humidity, dust, strong magnetic fields, explosive/corrosive mists or gases are present.
- Do not apply excessive vibration and shock to the device. This may damage the device.
- Avoid direct exposure to a high intensity light source. This may damage the image sensor.
- Do not install the device under unstable lighting conditions. Severe lighting change will affect the quality of the image produced by the device.
- Do not use solvents or thinners to clean the surface of the device. This can damage the surface finish.

Power Supply



- Applying incorrect power can damage the camera. If the voltage applied to the camera is greater or less than the camera's nominal voltage, the camera may be damaged or operate erratically. Please refer to [5.2 Specifications](#) for the camera's nominal voltage.
 - ※ Vieworks Co., Ltd. does NOT provide power supplies with the devices.
- Make sure the power is turned off before connecting the power cord to the camera. Otherwise damage to the camera may result.

Cleaning the Sensor Surface

Avoid cleaning the surface of the camera's sensor if possible. If you have dust or foreign matter on the sensor surface, use a soft lint free cotton bud dampened with a small quantity of high quality lens cleaner. Because electrostatic discharge (ESD) can damage the sensor, you must use a cloth (e.g. cotton) that will not generate static during cleaning.



Avoid dust or foreign matter on the sensor surface.

The camera is shipped with a protective plastic seal on the camera front. To prevent collecting dust or foreign matter on the camera sensor, make sure that you always put the protective seal in place when there is no lens mounted on the camera. In addition, make sure to always point the camera downward when there is no protective seal on the camera front or no lens mounted.

Procedures for Cleaning the Sensor

If you have dust or foreign matter on the sensor surface, follow the procedures below to wipe off.

1. Remove a contaminant by using an ionizing air gun.
If this step does not remove the contaminant, proceed to the next step.
2. Clean the contaminant on the sensor using one drop of lens cleaner on a non-fluffy cotton bud.
3. Wipe the cotton bud gently in only one direction (either left to right or right to left). Avoid wiping back and forth with the same cotton bud in order to ensure that the contaminants are removed and not simply transferred to a new location on the sensor surface.
4. Mount a lens, set the lens at a smaller aperture (e.g. F8), and then acquire images under bright lighting conditions. Check the images on the monitor for dark spots or stripes caused by the contaminant. Repeat the steps above until there is no contaminant present.



If the sensor is damaged due to electrostatic discharge or the sensor surface is scratched during cleaning, the warranty is void.

2 Warranty

Do not open the housing of the camera. The warranty becomes void if the housing is opened.
For information about the warranty, please contact your local dealer or factory representative.

3 Compliance & Certifications

3.1 FCC Compliance

This equipment has been tested and found to comply with the limits for a Class A digital device, pursuant to part 15 of the FCC Rules. These limits are designed to provide reasonable protection against harmful interference when the equipment is operated in a commercial environment. This equipment generates, uses, and can radiate radio frequency energy and, if not installed and used in accordance with the instruction manual, may cause harmful interference to radio communications. Operation of this equipment in a residential area is likely to cause harmful interference in which case the user will be required to correct the interference at his own expenses.

3.2 CE: DoC

EMC Directive 2014/30/EU
EN 55032:2012 (Class A), EN 55024:2010
Class A

3.3 KC

KCC Statement

Type	Description
Class A (Broadcasting Communication Device for Office Use)	This device obtained EMC registration for office use (Class A), and may be used in places other than home. Sellers and/or users need to take note of this.

4 Package Components

Package Components



VTC-2K10.5G-C19A-80 Camera with M42 mount

5 Product Specifications

5.1 Overview

The VTC-2K10.5G camera, a hybrid Time Delayed Integration (TDI) color line scan camera, provides faster line rates and higher sensitivity than existing line scan cameras. With hybrid TDI line scan technology combining the strengths of both CCD and CMOS image sensors, the M42 mount based VTC-2K10.5G-C19A-80 camera can acquire True Color images at faster line rates of up to 19 klz with up to 80× higher sensitivity.

Featured with high speed and high sensitivity, the VTC-2K10.5G camera is ideal for demanding applications such as flat panel display inspection, wafer inspection, printed circuit board inspection, and high performance document scanning.

Main Features

- Hybrid TDI Color Line Scan
- True Color Imaging
- 2160 × 80 Pixel Resolution
- Bidirectional Operations with up to 80 TDI Stages
- Anti-blooming
- Trigger Rescaler and Strobe Output Control
- GigE Interface up to 19 klz
- Advanced PRNU and DSNU Correction
- Area Scan Mode for Camera Alignment

Applications

- Flat Panel Display Inspection
- Printed Circuit Board Inspection
- Wafer Inspection
- High Performance Document Scanning

5.2 Specifications

Technical specifications for the VTC-2K10.5G camera are as follows:

Specification		VTC-2K10.5G-C19A-80
Active Image(H × V)		2160 × 80
Sensor Type		Hybrid TDI Color Line Scan
Pixel Size		10.5 μm × 10.5 μm
Interface		Gigabit Ethernet
Pixel Data Format		8 / 10 / 12 bit
TDI Stage		20 / 40 / 60 / 80
TDI Direction		Programmable
Trigger Synchronization		Free-Run, External Trigger Signal Programmable Line Rate
Max. Line Rate		19 kHz
Min. Line Rate		1 kHz
Throughput		0.04 Gpix/s
Gamma Correction		User Defined LUT (Look Up Table)
Black Level		Adjustable (-255 ~ 255 at 8 bits)
Gain Control		Analog Gain: 1×, 2×, 3×, 4× / Digital Gain: 1.0× ~ 8.0×
External Trigger		External, 3.3 V – 5.0 V
Power	External	10 ~ 30 V DC
	Dissipation	Typ. 4.5 W
Environmental		Ambient Operating: 0°C ~ 50°C (Housing: 10°C ~ 50°C), Storage: -40°C ~ 70°C
Mechanical / Weight		60 mm × 60 mm × 36 mm, 223 g
API SDK		Vieworks Imaging Solution 7.X
Optical Interface		
Lens Mount		M42 × 1 mm
Sensor to Camera Front		10.10 mm (Optical Distance)
Sensor Alignment		
Flatness		±25 μm
x		±0.15 mm
y		±0.15 mm
z		±0.1 mm

Table 5.1 Specifications of the VTC-2K10.5G camera

5.3 Camera Block Diagram

The VTC-2K10.5G camera consists of three printed circuit boards (PCB), and its block diagram is shown below.

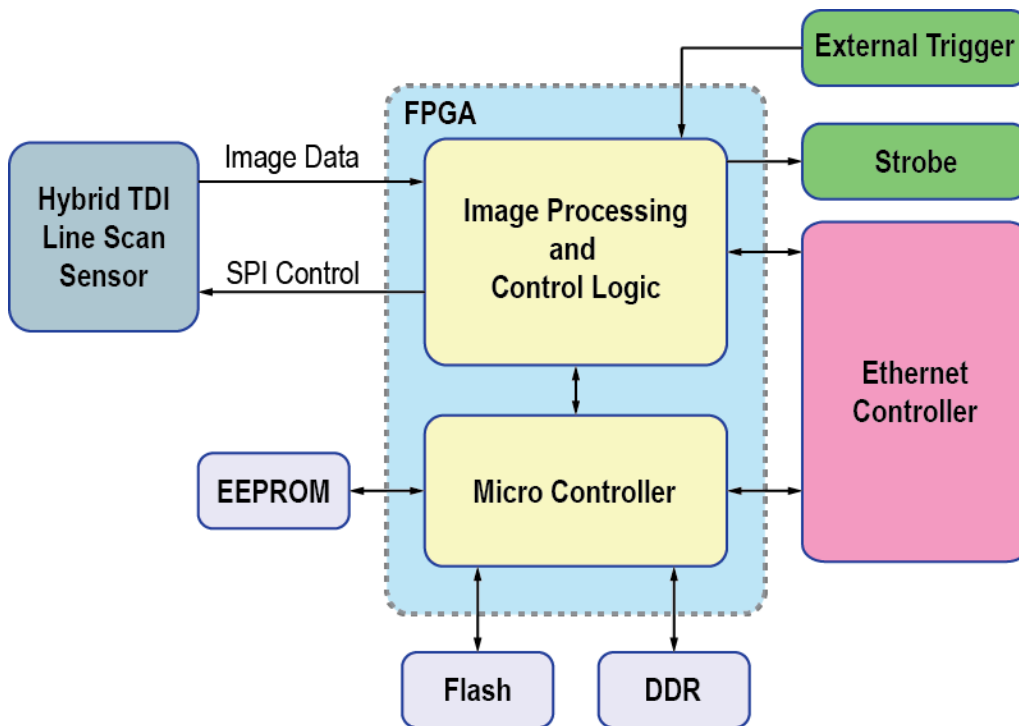

Figure 5.1 VTC-2K10.5G-C19A-80 Camera Block Diagram

5.4 Spectral Response

The following graphs show the spectral response for the VTC-2K10.5G camera.

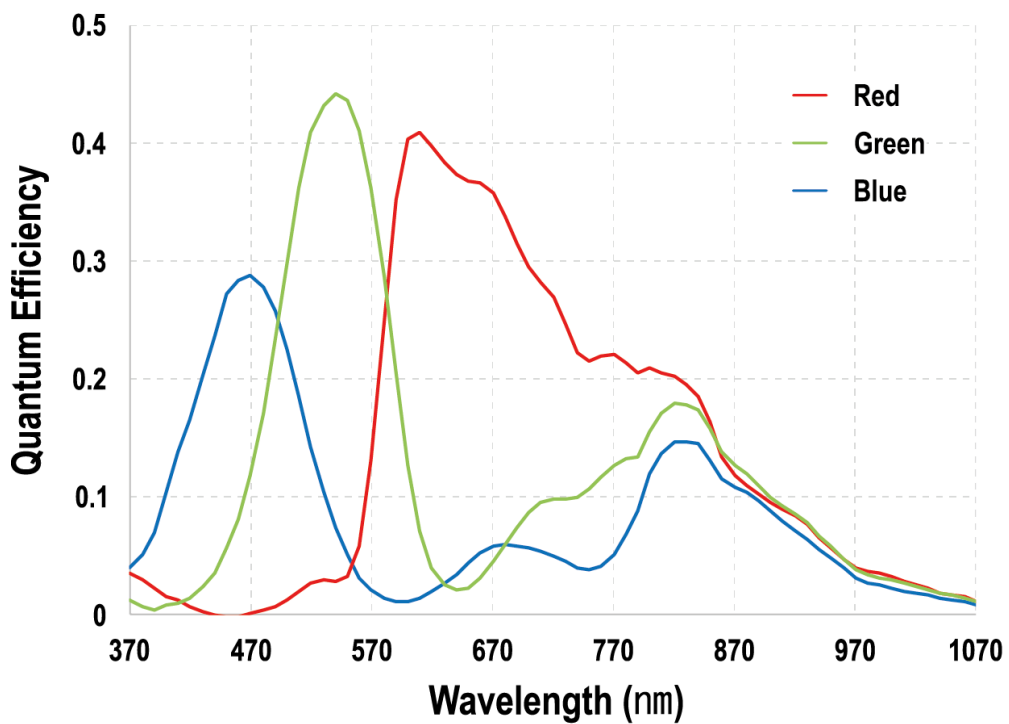

Figure 5.2 Quantum Efficiency

5.5 Mechanical Specification

The camera dimensions in millimeters are shown in the following figure.

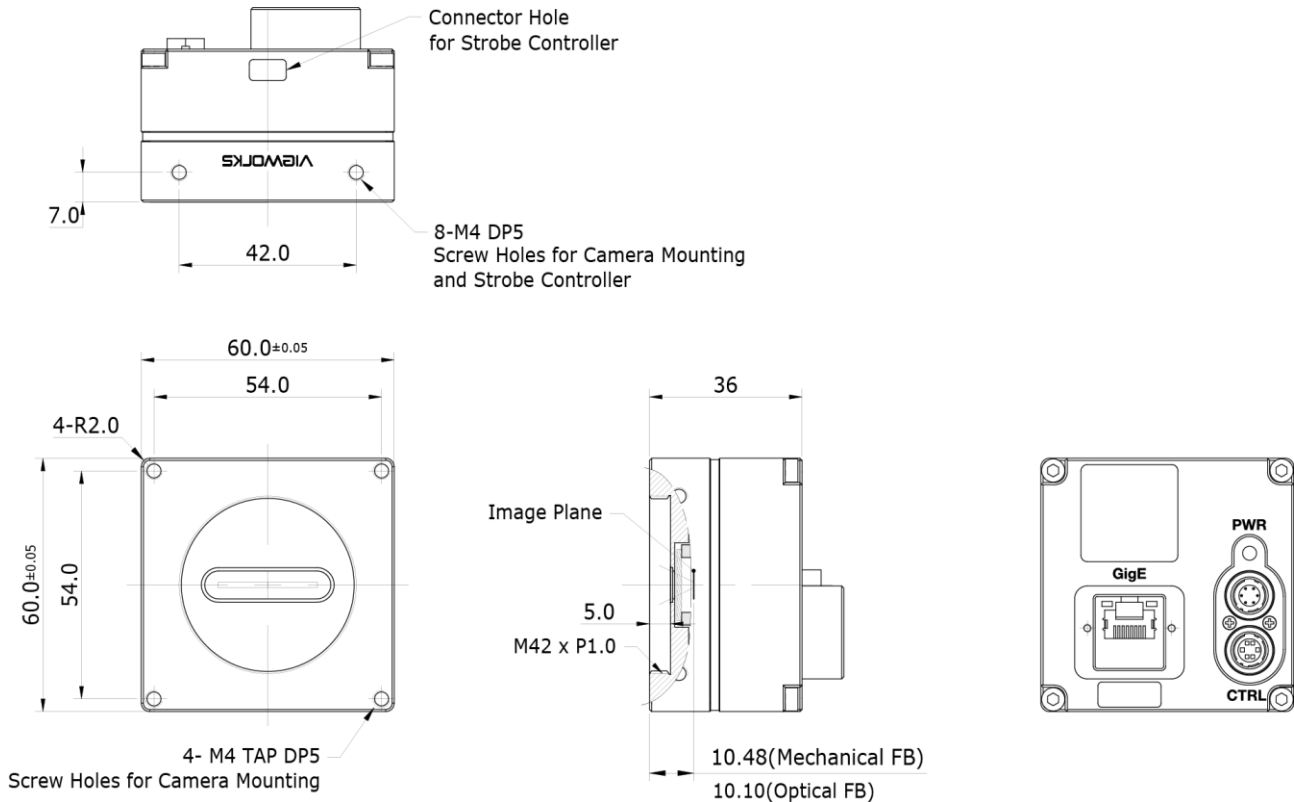

Figure 5.3 VTC-2K10.5G Mechanical Dimension

5.5.1 Camera Mounting and Heat Dissipation

You must mount the camera on a heat dissipation structure to maintain the temperature of the camera housing at 50°C or less. Given the low power consumption of the VTC camera, its housing temperature during operation will generally stay within the specified limits. However, overheating can occur if heat dissipation is restricted or if the camera is mounted on a severe environment. We strongly recommend that you follow the general guidelines below when you mount the camera.

- In all cases, you should monitor the temperature of the camera housing and make sure that the temperature does not exceed 50°C. You can monitor the internal temperature of the camera by using the **Device Temperature** parameter.
- If your camera is mounted on a metal component in your system, this may provide sufficient heat dissipation.

6 Software Licensing Information

The software in the VTC-2K10.5G camera includes the lightweight IP (lwIP) TCP/IP implementation. The software licensing information for this implementation is as follows.

Copyright (c) 2001-2004 Swedish Institute of Computer Science.

All rights reserved.

Redistribution and use in source and binary forms, with or without modification, are permitted provided that the following conditions are met:

1. Redistributions of source code must retain the above copyright notice, this list of conditions and the following disclaimer.
2. Redistributions in binary form must reproduce the above copyright notice, this list of conditions and the following disclaimer in the documentation and/or other materials provided with the distribution.
3. The name of the author may not be used to endorse or promote products derived from this software without specific prior written permission.

THIS SOFTWARE IS PROVIDED BY THE AUTHOR "AS IS" AND ANY EXPRESS OR IMPLIED WARRANTIES, INCLUDING, BUT NOT LIMITED TO, THE IMPLIED WARRANTIES OF MERCHANTABILITY AND FITNESS FOR A PARTICULAR PURPOSE ARE DISCLAIMED. IN NO EVENT SHALL THE AUTHOR BE LIABLE FOR ANY DIRECT, INDIRECT, INCIDENTAL, SPECIAL, EXEMPLARY, OR CONSEQUENTIAL DAMAGES (INCLUDING, BUT NOT LIMITED TO, PROCUREMENT OF SUBSTITUTE GOODS OR SERVICES; LOSS OF USE, DATA, OR PROFITS; OR BUSINESS INTERRUPTION) HOWEVER CAUSED AND ON ANY THEORY OF LIABILITY, WHETHER IN CONTRACT, STRICT LIABILITY, OR TORT (INCLUDING NEGLIGENCE OR OTHERWISE) ARISING IN ANY WAY OUT OF THE USE OF THIS SOFTWARE, EVEN IF ADVISED OF THE POSSIBILITY OF SUCH DAMAGE.

7 Connecting the Camera

The following instructions assume that you have installed a Gigabit Ethernet card including related software and Vieworks Imaging Solution in your computer. For more information, refer to Vieworks Imaging Solution Installation Manual. To connect the camera to your computer, follow the steps below.

1. Make sure that the power supply is not connected to the camera and your computer is turned off.
2. Plug one end of an Ethernet cable into the RJ45 jack on the camera and the other end of the Ethernet cable into the Ethernet card in your computer.
3. Connect the plug of the power adapter to the power input receptacle on the camera.
4. Plug the power adapter into a working electrical outlet.
5. Verify all the cable connections are secure.

7.1 Precaution to Center the Image Sensor

- Users do not need to center the image sensor as it is adjusted as factory default settings.
- When you need to adjust the center of the image sensor, please contact your local dealer or the manufacturer for technical assistance.

7.2 Installing Vieworks Imaging Solution

You should perform the software installation first and then the hardware installation.

You can download the Vieworks Imaging Solution at <http://www.vieworks.com>.

8 Camera Interface

8.1 General Description

As shown in the figure below, 3 types of connectors and a status indicator LED are located on the back of the camera and have the functions as follows:

- ① RJ-45 Jack: transmits video data and controls the camera.
- ② Status LED: displays power status and operation mode.
- ③ 6 pin power input receptacle: supplies power to the camera.
- ④ 6 pin control receptacle: provides access to the camera's I/O lines.

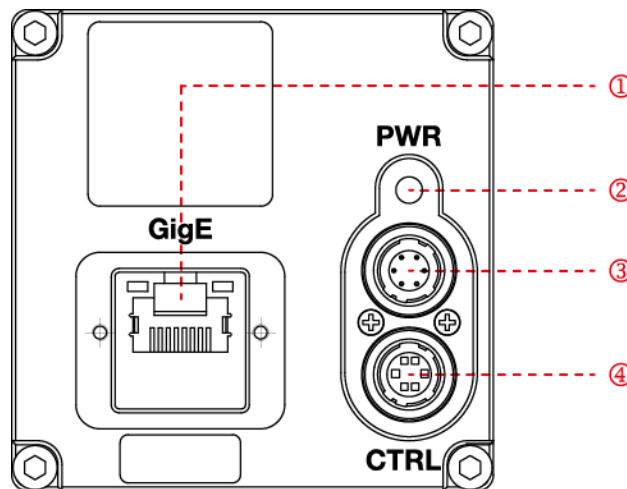

Figure 8.1 VTC-2K10.5G Back Panel

8.2 RJ-45 Jack

The 8-pin RJ-45 jack provides Ethernet access to the camera. The pin assignments for the RJ-45 jack adhere to the Ethernet standard.

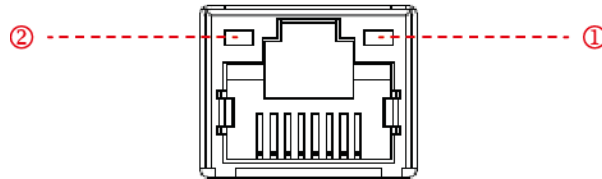

Figure 8.2 RJ-45 Jack

- ① Ethernet Link LED (Orange): LED is lit when Ethernet link is active.
- ② Ethernet Active LED (Green): LED blinks when Rx/Tx is active.

PAIR List	Pin	Signal Name	Type	Description
PAIR 0	1	+TXA	Differential	Gigabit Ethernet Transceiver
	2	-TXA	Differential	Gigabit Ethernet Transceiver
PAIR 1	3	+TXB	Differential	Gigabit Ethernet Transceiver
	6	-TXB	Differential	Gigabit Ethernet Transceiver
PAIR 2	4	+TXC	Differential	Gigabit Ethernet Transceiver
	5	-TXC	Differential	Gigabit Ethernet Transceiver
PAIR 3	7	+TXD	Differential	Gigabit Ethernet Transceiver
	8	-TXD	Differential	Gigabit Ethernet Transceiver

Table 8.1 Pin Assignments for RJ-45 Jack

8.3 Power Input Receptacle

The power input receptacle is a Hirose 6-pin connector (part # HR10A-7R-6PB). The pin assignments and configurations are as follows:

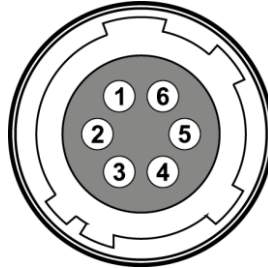

Figure 8.3 Pin Assignments for 6-pin Power Input Receptacle

Pin Number	Signal	Type	Description
1, 2, 3	DC Power +	Input	DC Power Input
4, 5, 6	DC Ground -	Input	DC Ground

Table 8.2 Pin Arrangements for Power Input Receptacle



- A recommended mating connector for the Hirose 6 pin connector is the Hirose 6 pin plug (part # HR10A-7P-6S) or the equivalent.
- It is recommended that you use the power adapter, which has at least 3 A current output at 10 ~ 30 V voltage output (User needs to purchase a power adapter separately.).

Precaution for Power Input



- Make sure the power is turned off before connecting the power cord to the camera. Otherwise, damage to the camera may result.
- If the voltage applied to the camera is greater than specified in the specifications, damage to the camera may result.

8.4 Control I/O Receptacle

The control I/O receptacle is a Hirose 6-pin connector (part # HR10A-7R-6SB) and consists of an external trigger signal input and strobe output ports. The pin assignments and configurations are as follows:

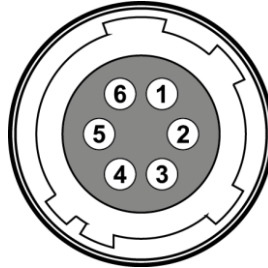

Figure 8.4 Pin Assignments for 6-pin Control I/O Receptacle

Pin Number	Signal	Type	Description
1	Trigger Input 1 + (TTL1)	Input	3.3 V ~ 5.0 V LVDS input, TTL input
2	Trigger Input 1 -	Input	
3	Strobe Out	Output	3.3 V TTL Output Output resistance: 47 Ω
4	DC Ground	-	DC Ground / TTL Ground
5	Trigger Input 2 + (TTL2)	Input	3.3 V ~ 5.0 V LVDS input, TTL input
6	Trigger Input 2 -	Input	

Table 8.3 Pin Arrangements for Control I/O Receptacle



A recommended mating connector for the Hirose 6 pin connector is the Hirose 6 pin plug (part # HR10A-7P-6P) or the equivalent.

8.5 Trigger Input Circuit

The 6-pin Control I/O receptacle on the camera is equipped with two input lines designated as Trigger Input 1 and Trigger Input 2. The following figure shows trigger input circuit designed to receive two pairs of Low Voltage Differential Signaling (LVDS) signals. Transmitted trigger signal is applied to the internal circuit through a CMOS buffer with a good noise margin. The minimum trigger width that can be recognized by the camera is 1 μ s. If transmitted signal is less than 1 μ s, the camera will ignore the trigger signal. An external trigger circuit example is shown below.

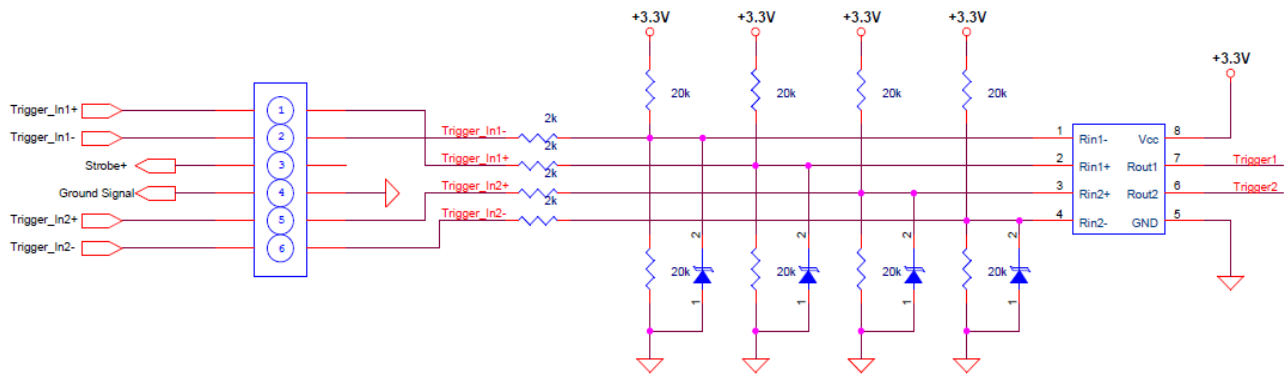

Figure 8.5 Trigger Input Schematic

8.6 Strobe Output Circuit

The strobe output signal comes out through a 3.3 V output level of Line Driver IC. A pulse width of the signal is synchronized with a Line Start trigger (shutter) signal of the camera (refer to [10.14 Strobe Mode](#)).

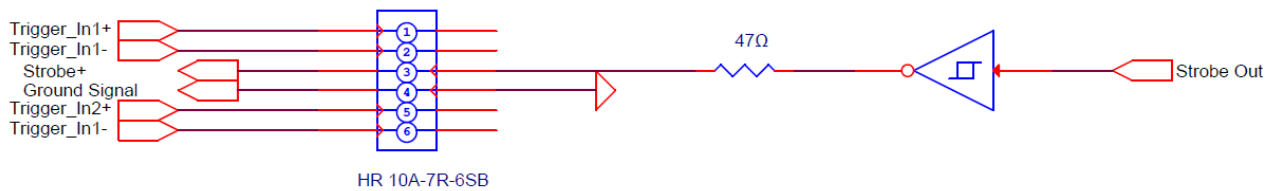

Figure 8.6 Strobe Output Schematic

9 Acquisition Control

This chapter provides detailed information about the following elements involved with the image acquisition.

- Acquisition Start/Stop commands and Acquisition Mode parameter
- Frame Start trigger
- Line Start trigger
- Line Rate control

9.1 Acquisition Start/Stop Commands and Acquisition Mode

The **Acquisition Start** command prepares the camera to acquire images. The camera cannot acquire images unless an **Acquisition Start** command has first been executed.

Executing an **Acquisition Stop** command terminates the camera's ability to acquire images.

A parameter called the **Acquisition Mode** has a direct bearing on how the **Acquisition Start** command operates. The VTC-2K10.5G camera only supports **Continuous** for the **Acquisition Mode** parameter.

The **Acquisition Start** command will remain in effect until you execute an **Acquisition Stop** command. Once an **Acquisition Stop** command has been executed, the camera will not be able to acquire images until a new **Acquisition Start** command is executed.

9.2 Frame Start Trigger

The Frame Start trigger is used in conjunction with the Line Start trigger to control the acquisition of the lines that will be included in each frame. The camera can only react to Line Start triggers when the Frame Start trigger is valid. When the Frame Start trigger is not valid, the camera will ignore Line Start triggers and will not be able to acquire line images.

You can select the Frame Start trigger by using the **Trigger Selector** parameter. The Frame Start trigger can be generated within the camera or may be applied externally by setting the **Trigger Source** parameter to **LineIn0** or **LineIn1**. The main parameter associated with the Frame Start trigger is the **Trigger Mode** parameter.

The **Trigger Mode** parameter for the Frame Start trigger has two available settings: **Off** and **On**.

9.2.1 Trigger Mode (Frame Start) = Off

When the **Trigger Mode** parameter is set to **Off**, the camera will generate all required Frame Start trigger signals internally, and you do not need to apply Frame Start trigger signals to the camera.

If the **Trigger Mode** parameter is set to **Off**, the camera will automatically begin generating Frame Start trigger signals when it receives an **Acquisition Start** command.

The following describes how the camera operates the Frame Start trigger.

1. The camera will automatically make the Frame Start trigger valid when it receives an **Acquisition Start** command.
2. The Frame Start trigger will remain valid until enough lines have been acquired to constitute a complete frame. The Frame Start trigger will then become invalid.
3. The Frame Start trigger will automatically be made valid when the camera can start acquisition of lines for a next frame. The Frame Start trigger will remain valid until enough lines have been acquired to constitute a complete frame, and then will become invalid.
4. The step 3 will be repeated until the camera receives an **Acquisition Stop** command. When the **Acquisition Stop** command is received, the Frame Start trigger will become continuously invalid.

9.2.2 Trigger Mode (Frame Start) = On

When the **Trigger Mode** parameter is set to **On**, you must select a source signal for the Frame Start trigger.

The **Trigger Source** parameter specifies the source signal that will act as the Frame Start trigger signal.

The available settings for the **Trigger Source** parameter are:

- **LineIn0/1:** You can apply a Frame Start trigger signal to the camera by injecting an externally generated electrical signal (commonly referred to as a hardware or external trigger signal) into the control I/O receptacle on the camera. Refer to [8.5 Trigger Input Circuit](#) for more information.

If the **Trigger Source** parameter is set to **LineIn0/1**, you must also set the **Trigger Activation** parameter.

The available settings for the **Trigger Activation** parameter are:

- **Rising Edge:** Specifies that a rising edge of the source signal will make the Frame Start trigger valid. The Frame Start trigger will remain valid until enough lines have been acquired to constitute a complete frame and then will become invalid.
- **Falling Edge:** Specifies that a falling edge of the source signal will make the Frame Start trigger valid. The Frame Start trigger will remain valid until enough lines have been acquired to constitute a complete frame and then will become invalid.
- **Any Edge:** Specifies that both rising and falling edges of the source signal will make the Frame Start trigger valid. The Frame Start trigger will remain valid until enough lines have been acquired to constitute a complete frame and then will become invalid.
- **Level High:** Specifies that a rising edge of the source signal will make the Frame Start trigger valid. The Frame Start trigger will remain valid as long as the signal remains high. The Frame Start trigger will become invalid when the signal becomes low.
- **Level Low:** Specifies that a falling edge of the source signal will make the Frame Start trigger valid. The Frame Start trigger will remain valid as long as the signal remains low. The Frame Start trigger will become invalid when the signal becomes high.

9.3 Line Start Trigger

The Line Start trigger is used to begin a line acquisition. The camera can only react to a Line Start trigger when the Frame Start trigger is valid. If a Line Start trigger is applied to the camera when the Frame Start trigger is invalid, the Line Start trigger will be ignored by the camera.

You can select the Line Start trigger by using the **Trigger Selector** parameter. The Line Start trigger can be generated within the camera or may be applied externally by setting the **Trigger Source** parameter to **LineIn0** or **LineIn1**. If a Line Start trigger is applied to the camera, the camera will begin to acquire line images.

The main parameter associated with the Line Start trigger is the **Trigger Mode** parameter. The **Trigger Mode** parameter for the Line Start trigger has two available settings: **Off** and **On**.

9.3.1 Trigger Mode (Line Start) = Off

When the **Trigger Mode** parameter is set to **Off**, the camera will generate all required Line Start trigger signals internally, and you do not need to apply Line Start trigger signals to the camera.

If the **Trigger Mode** parameter is set to **Off**, the camera will automatically begin generating Line Start trigger signals when it receives an **Acquisition Start** command. The camera will continue to generate Line Start trigger signals until it receives an **Acquisition Stop** command.



Free Run

When you set the **Trigger Mode** parameter to **Off**, the camera will generate all required trigger signals internally. When the camera is set this way, it will constantly acquire images without any need for triggering by the user. This use case is commonly known as “free run”.

The rate at which the Line Start trigger signals are generated may be determined by the camera's **Acquisition Line Rate** parameter.

- If the parameter is set to a value less than the maximum allowed line rate with the current camera settings, the camera will generate line start trigger signals at the rate specified by the parameter setting.
- If the parameter is set to a value greater than the maximum allowed line rate with the current camera settings, the camera will generate line start trigger signals at the maximum allowed line rate.

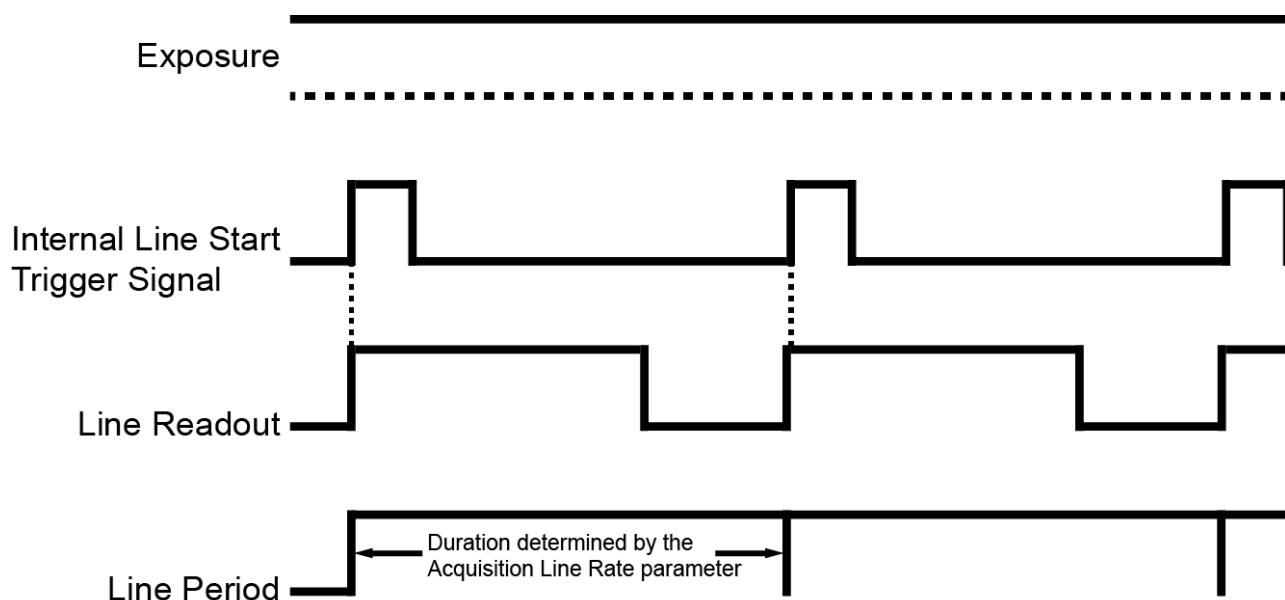

Figure 9.1 Trigger Mode (Line Start) = Off

9.3.2 Trigger Mode (Line Start) = On

When the **Trigger Mode** parameter is set to **On**, you must apply a Line Start trigger signal to the camera each time you want to begin an image acquisition. The **Trigger Source** parameter specifies the source signal that will act as the Line Start trigger signal.

The available settings for the **Trigger Source** parameter are:

- **LineIn0/1:** You can apply a Line Start trigger signal to the camera by injecting an externally generated electrical signal (commonly referred to as a hardware or external trigger signal) into the control I/O receptacle on the camera. Refer to [8.5 Trigger Input Circuit](#) for more information.

If the **Trigger Source** parameter is set to **LineIn0/1**, you must also set the **Trigger Activation** parameter.

The available settings for the **Trigger Activation** parameter are:

- **Rising Edge:** Specifies that a rising edge of the electrical signal will act as the Line Start trigger.
- **Falling Edge:** Specifies that a falling edge of the electrical signal will act as the Line Start trigger.
- **Any Edge:** Specifies that both rising and falling edges of the electrical signal will act as the Line Start trigger.

When the **Trigger Mode** parameter is set to **On**, the camera's line rate can be controlled by manipulating the external trigger signal. At this point, it is important that you do not attempt to trigger images at a rate that is greater than the maximum allowed.

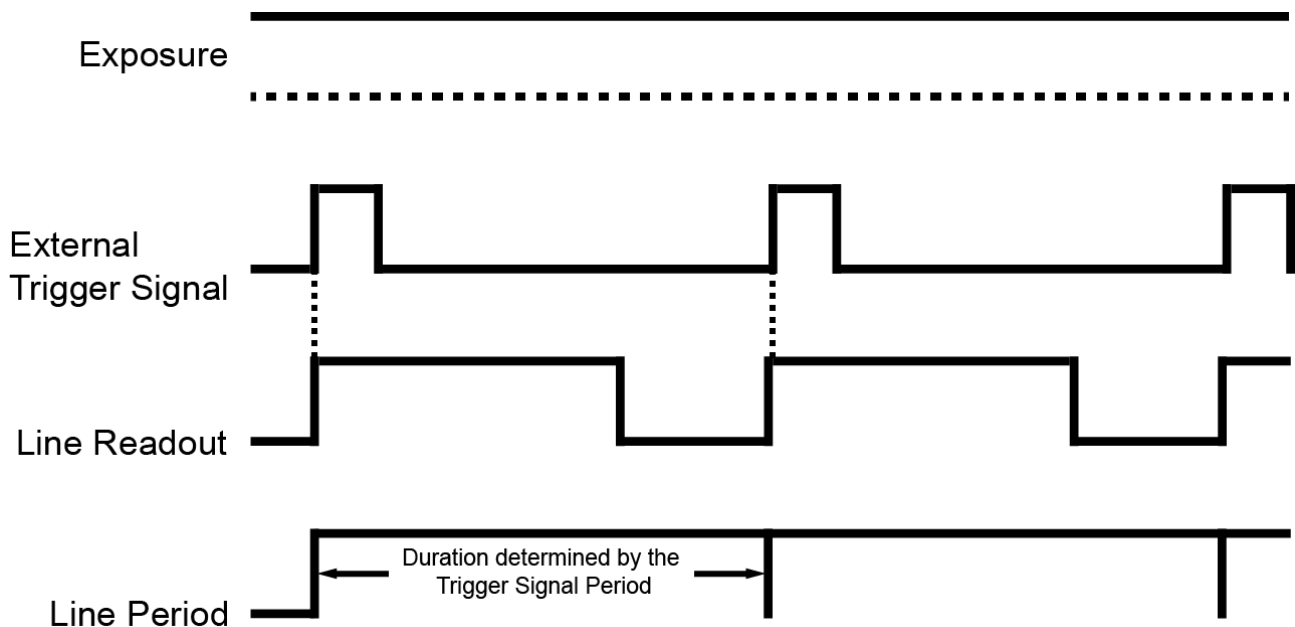

Figure 9.2 Trigger Mode (Line Start) = On

9.3.3 Using an External Trigger Signal

You can apply a Frame Start and Line Start trigger signal to the camera by injecting an externally generated electrical signal into the control I/O receptacle on the camera.

How to apply Frame Start trigger signal via externally generated signal

1. Set the **Trigger Selector** parameter to **Frame Start**.
2. Set the **Trigger Mode** parameter to **On**.
3. Set the **Trigger Source** parameter to **LineIn0/1**.
4. Use the **Trigger Activation** parameter to select rising edge, falling edge, any edge, level high or level low triggering.
5. Each time a proper electrical signal is applied to the camera, an occurrence of the Frame Start trigger signal will be recognized by the camera.

How to apply Line Start trigger signal via externally generated signal

1. Set the **Trigger Selector** parameter to **Line Start**.
2. Set the **Trigger Mode** parameter to **On**.
3. Set the **Trigger Source** parameter to **LineIn0/1**.
4. Use the **Trigger Activation** parameter to select rising edge, falling edge or any edge triggering.
5. Each time a proper electrical signal is applied to the camera, an occurrence of the Line Start trigger signal will be recognized by the camera.
6. When the camera is operating under control of an external Line Start trigger signal, the period of trigger signal will determine the rate at which the camera is acquiring images:

$$\text{Line Rate (Hz)} = \frac{1}{\text{External signal period in seconds}}$$

For example, if you are operating a camera with an external trigger signal period of 200 μs (0.0002 s):

So in this case, the line rate is 5 kHz.

9.3.4 Use Case

The use cases included in this section describe how the Frame Start trigger and the Line Start trigger will work with common combinations of parameter settings.

Use Case 1 – Frame Start and Line Start Triggering Off (Free-Run)

In this use case, the **Trigger Mode** parameter for the Frame Start trigger and the Line Start trigger is set to **Off**. The camera will internally generate the Frame Start and the Line Start trigger signals.

Camera Parameter Settings:

- Trigger Mode (Frame Start) = Off
- Height (Lines per Frame) = N
- Trigger Mode (Line Start) = Off

--- : trigger signal internally generated by the camera
 ▾ : a frame acquisition completed

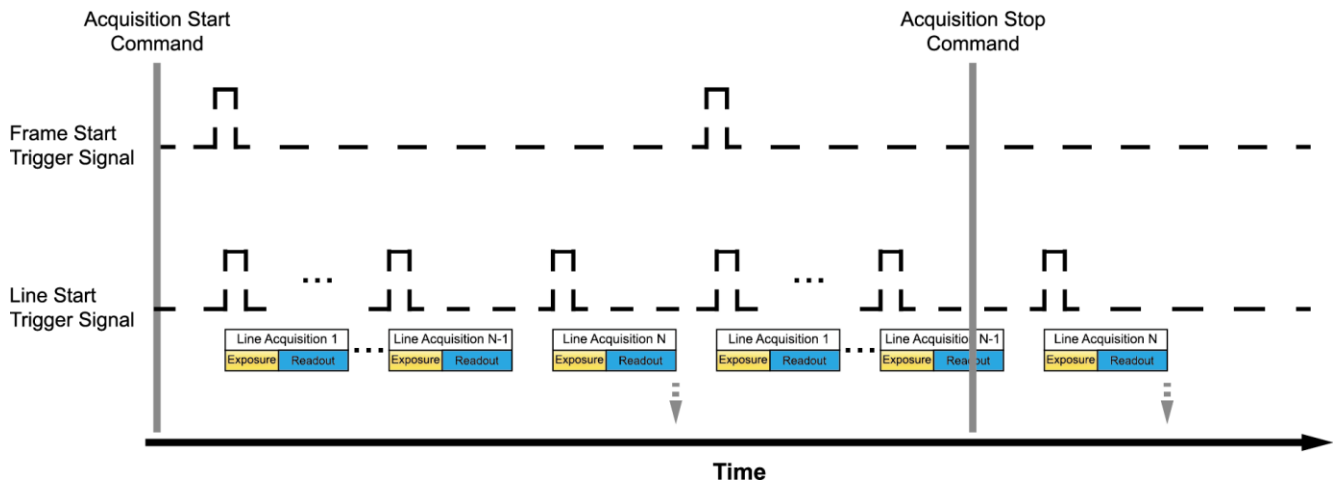

Figure 9.3 Frame Start and Line Start Triggering Off (Free-Run)

Use Case 2 – Frame Start and Line Start Triggering On

In this use case, the **Trigger Mode** parameter for the Frame Start trigger and the Line Start trigger is set to **On**. You need to apply the Frame Start trigger and the Line Start trigger signals to the camera.

Camera Parameter Settings:

- Trigger Mode (Frame Start) = On
- Trigger Source (Frame Start) = LineIn0
- Trigger Activation (Frame Start) = Rising Edge
- Height (Lines per Frame) = N
- Trigger Mode (Line Start) = On
- Trigger Source (Line Start) = LineIn1
- Trigger Activation (Line Start) = Rising Edge

— : trigger signal externally applied by the user

⋮ : a frame acquisition completed

□ : trigger signal ignored by the camera

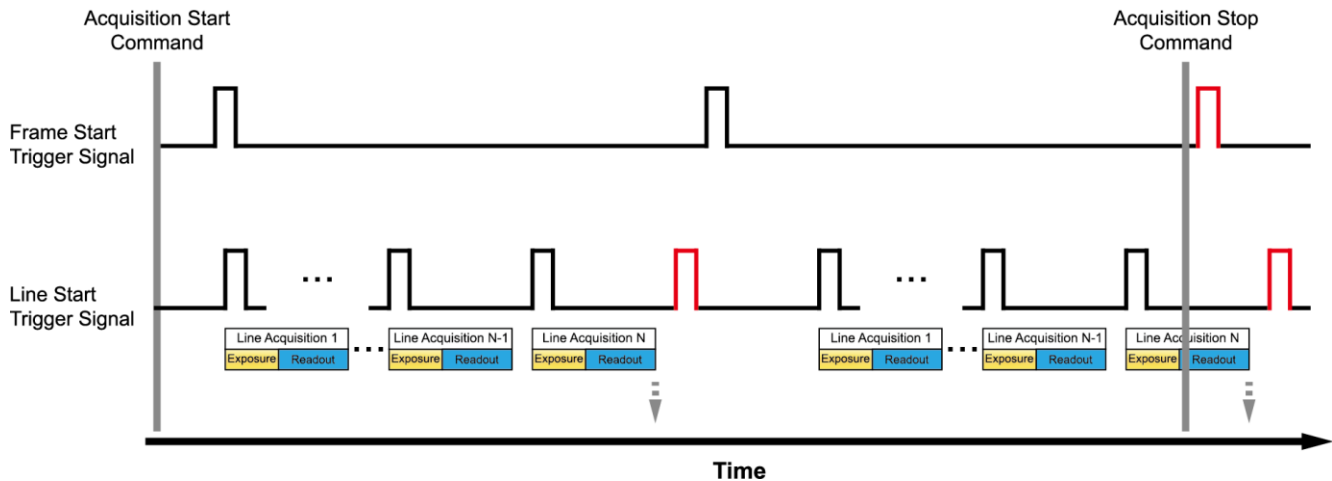

Figure 9.4 Frame Start and Line Start Triggering On

Use Case 3 – Frame Start and Line Start Triggering On with Frame Start Trigger set to Level High

In this use case, the **Trigger Mode** parameter for the Frame Start trigger and the Line Start trigger is set to **On**. The **Trigger Activation** parameter for the Frame Start trigger is set to **Level High**. This means that the Frame Start trigger will remain valid as long as the signal remains high.

Camera Parameter Settings:

- Trigger Mode (Frame Start) = On
- Trigger Source (Frame Start) = LineIn0
- Trigger Activation (Frame Start) = Level High
- Height (Lines per Frame) = N
- Trigger Mode (Line Start) = On
- Trigger Source (Line Start) = LineIn1
- Trigger Activation (Line Start) = Rising Edge

— : trigger signal externally applied by the user

⋮ : a frame acquisition completed

□ : trigger signal ignored by the camera

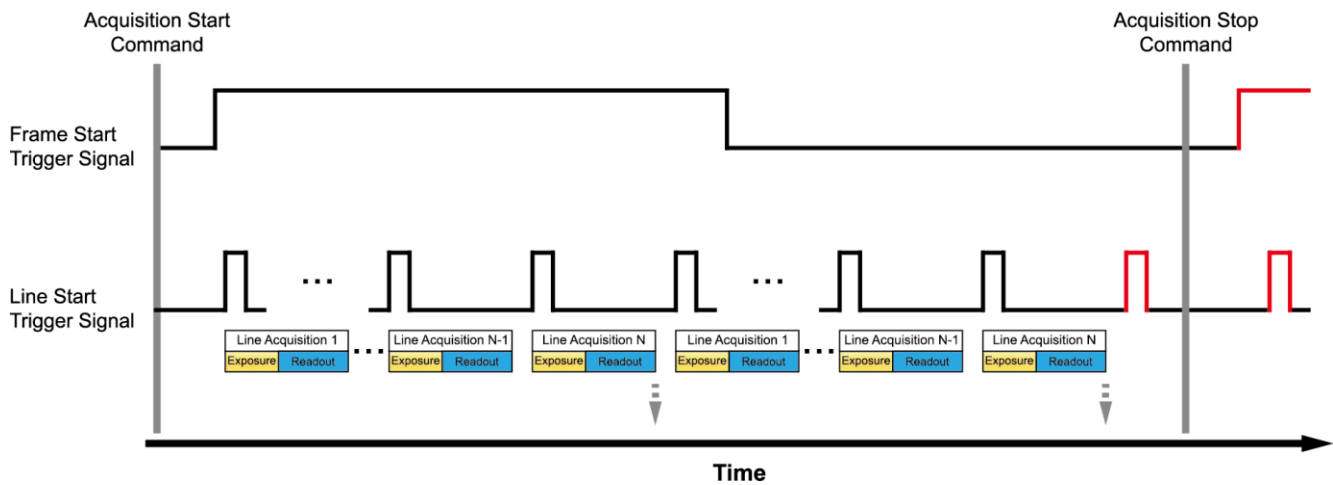

Figure 9.5 Frame Start and Line Start Triggering On with Frame Start Trigger set to Level High

9.3.5 Trigger Rescaler Mode

With the **Trigger Rescaler Mode**, you can modulate the period of the external trigger signal as desired. For example, if you supply external trigger signals into the camera's I/O receptacle using the conveyor's encoder, the number of output pulses per revolution of the encoder is fixed. In this situation, you can modulate the period of the trigger signal received from the camera in the following manner to match the pitch of the image in vertical direction.

$$\text{Line Rate (Hz)} = \text{External Trigger Line Rate} \times \text{Trigger Rescaler Rate}$$

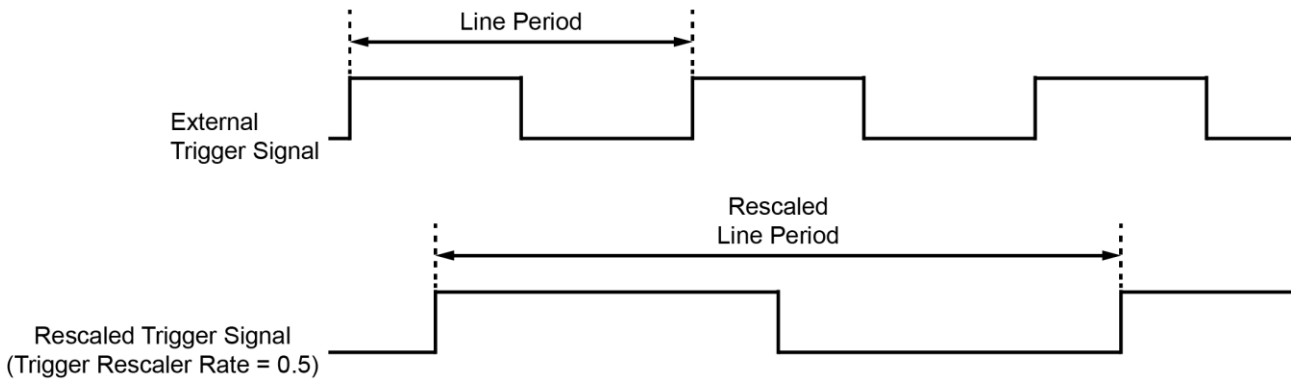

Figure 9.6 Trigger Rescaler Rate = 0.5

The XML parameters related to Trigger Rescaler Mode are as follows.

XML Parameters		Value	Description
AcquisitionControl	TriggerRescalerMode	Off	Disables Trigger Rescaler Mode.
		On	Enables Trigger Rescaler Mode.
	TriggerRescalerRate	0.010000 ~ 100.000000	Sets the trigger rescaler rate for converting trigger signals.
	TriggerRescalerFilter	Sets the rescaler filter factor to decrease the jitter of the external trigger signals.	
		SIZE16	Sets the rescaler filter factor to 16.
		SIZE32	Sets the rescaler filter factor to 32.
		SIZE64	Sets the rescaler filter factor to 64.
		SIZE128	Sets the rescaler filter factor to 128.
SIZE256		Sets the rescaler filter factor to 256.	
	SIZE512	Sets the rescaler filter factor to 512.	

Table 9.1 XML Parameters related to Trigger Rescaler Mode

9.3.6 Trigger Statistics

The Trigger Statistics feature allows you to determine the trigger signals applied to the camera and then converted by the Trigger Rescaler.

The XML parameters related to Trigger Statistics are as follows.

XML Parameters		Value	Description
TriggerStatistics	InputTriggerRate	-	Displays the rate at which the input trigger signals are applied to the camera in Hz.
	InputTriggerRateHighest	-	Displays the highest rate at which the input trigger signals are applied to the camera in Hz.
	InputTriggerJitter	-	Displays the jitter of the input trigger signals in %.
	InputTriggerDuration	-	Displays the pulse duration of the input trigger signals in μ s.
	RescaledTriggerRate	-	Displays the rate of the trigger signals converted by the Trigger Rescaler in Hz.
	RescaledTriggerJitter	-	Displays the jitter of the input trigger signals converted by the Trigger Rescaler in %.

Table 9.2 XML Parameters related to Trigger Statistics

9.4 Maximum Allowed Line Rate

In general, the maximum allowed acquisition line rate on the camera may be limited by the following factors:

- The amount of time that it takes to transmit line images from the camera to your computer.
The amount of time needed to transmit line images depends on the bandwidth assigned to the camera.
- The amount of time it takes to read acquired line images out of the image sensor and into the camera's line buffer. This time varies depending on the length of image ROI. Images with a smaller length take less time to read out of the sensor. The image length is determined by the camera's **Width** settings under the **Image Format Control** category.

9.4.1 Increasing the Maximum Allowed Line Rate

You may find that you would like to acquire line images at a rate higher than the maximum allowed with the camera's current settings. In this case, you must adjust one or more of the factors that can influence the maximum allowed line rate and then check to see if the maximum allowed line rate has increased.

- The time that it takes to transmit line images out of the camera is the main limiting factor on the line rate. You can decrease the line transmission time (and thus increase the maximum allowed line rate) by doing one or more of the following:
 - Use an 8 bit pixel data format rather than 12 bit pixel format. Images with fewer bits per pixel will take less time to transmit.
 - Use a smaller length of ROI. Decreasing the length of ROI means that the camera has less data to transmit and therefore the transmission time will decrease.
 - Make sure that the Packet Size (DeviceStreamChannelPacketSize) parameter is set as high as possible for your system and that the Inter-packer delay (GevSCPD) parameter is set as low as possible.

10 Camera Features

10.1 Operation Mode

The VTC-2K10.5G camera has two different operation modes: **Area** and **TDI** (Time Delayed Integration).

If the **Operation Mode** parameter is set to **Area**, the camera will operate as an area scan camera using two dimensional array of pixels. This mode is useful for aligning the camera to your target object.

If the **Operation Mode** parameter is set to **TDI**, the camera will operate as a high sensitivity line scan camera and provide up to 80× higher sensitivity than existing line scan cameras.

The XML parameter related to Operation Mode is as follows.

XML Parameters		Value	Description
AcquisitionControl	OperationMode	TDI	Operates the camera in the TDI mode.
		Area	Operates the camera in the Area mode.

Table 10.1 XML Parameter related to Operation Mode

10.2 TDI Stages

In the **TDI** mode, the **TDI Stages** parameter is used to determine the number of integration stages used by the camera. For example, if the **TDI Stages** parameter is set to **80**, the camera will acquire images with 80× higher sensitivity.

In the **Area** mode, the **TDI Stages** parameter is used to determine the height of the image sensor. For example, if the **Operation Mode** parameter is set to **Area** and the **TDI Stages** parameter is set to **80** on the VTC-2K10.5G camera, the camera will acquire 2160 × 80 area images.

The XML parameter related to TDI Stages is as follows.

XML Parameters		Value	Description
ImageFormatControl	TDI Stages	20	Sets the number of TDI Stages to 20.
		40	Sets the number of TDI Stages to 40.
		60	Sets the number of TDI Stages to 60.
		80	Sets the number of TDI Stages to 80.

Table 10.2 XML Parameter related to TDI Stages

10.3 Scan Direction

In the **TDI** mode, the **Scan Direction** parameter is used to select the image sensor’s scan direction. You need to set the **Scan Direction** parameter to **Forward** if the object being imaged will pass the bottom of the camera, and then pass the top of the camera. On the contrary, you need to set the **Scan Direction** parameter to **Reverse** if the object being imaged will pass the top of the camera, and then pass the bottom of the camera.

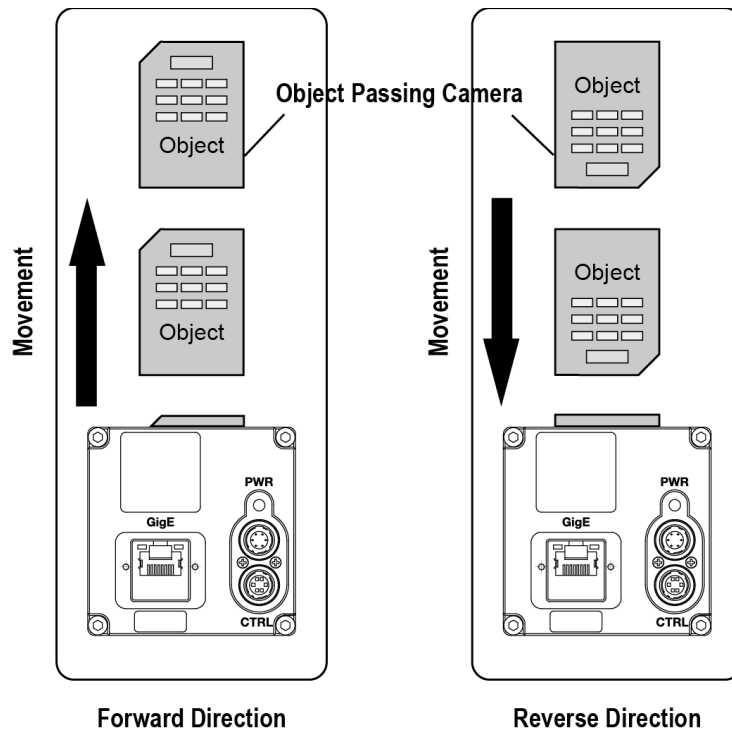

Figure 10.1 Scan Direction

XML Parameters		Value	Description
ImageFormatControl	Scan Direction	Forward	Scans images in the forward direction.
		Reverse	Scans images in the reverse direction.

Table 10.3 XML Parameter related to Scan Direction

When you set the **Scan Direction** parameter to **Reverse** in the **Area** mode, you can acquire vertically flipped images.

10.4 Region of Interest

The Region of Interest (ROI) feature allows you to specify a portion of the sensor lines. During operation, only the pixel information from the specified portion of the lines are read out of the sensor and transmitted from the camera to your computer.

The ROI is referenced to the left end of the sensor array. The location and size of the ROI is defined by declaring the **Offset X** and **Width** settings. For example, suppose that you set the Offset X parameter to 48 and the Width parameter to 288 as shown in the figure below. With these settings, the camera will read out and transmit pixel values for pixels 48 through 335.

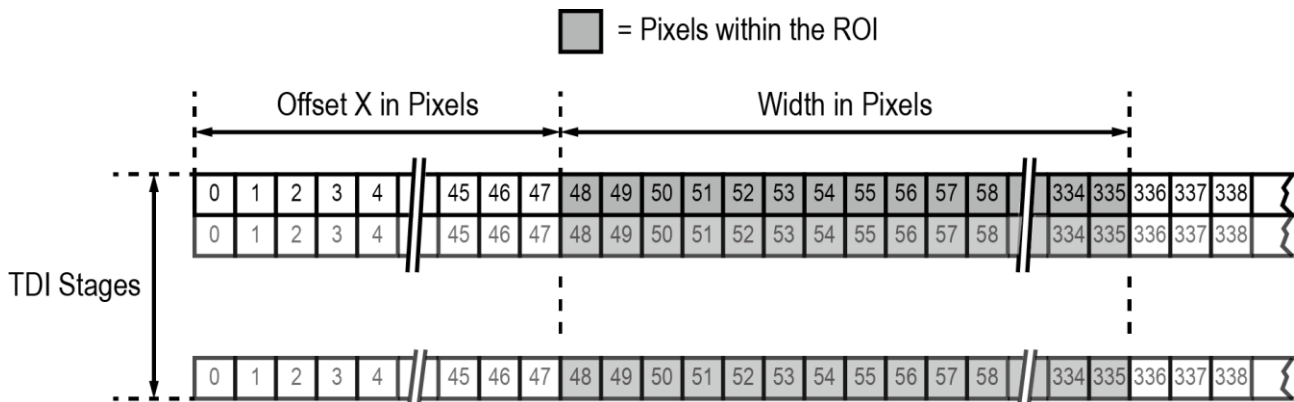

Figure 10.2 Region of Interest

10.4.1 Setting the ROI

By default, the ROI is set to use the full resolution of the camera's image sensor. You can change the size and location of the ROI by changing the Offset X and Width parameter values.

When you are setting the camera's region of interest, you must consider the following guidelines:

- The sum of the Offset X and Width setting values must not exceed the width of the camera's image sensor. For example, on the VTC-2K10.5G camera, the sum of the Offset X and Width setting values must not exceed 2160.
- The Offset X setting value can be set to 0 and can be increased in increments of 48. The Width setting value must be a minimum of 48 and can be set to a multiple of 48.

On the VTC-2K10.5G camera, the maximum line rates depending on ROI changes are shown below.

Width	VTC-2K10.5G
384	100.0 kHz
528	78.9 kHz
720	57.9 kHz
1056	39.5 kHz
1536	27.1 kHz
2160	19.3 kHz

Table 10.4 Maximum Line Rates by ROI Changes (RGB8 Pixel Format)

10.4.2 Setting the Height

Because the GigE TDI line scan camera is not working with a Frame Grabber, you must define a virtual frame by using the **Height** parameter. The **Height** parameter determines the number of lines that will be included in each frame. For example, assume that the **Height** parameter is set to 1024 and that the camera has just started to acquire line images. In this case, the camera will transmit line images to your computer, and then your computer will recognize 1024 line images as a frame.

XML Parameters	Value	Description	
ImageFormatControl	Width	48 ~ 2160	Sets the width of line images.
	Height	1 ~ 4096	Defines the height of a virtual image.
	OffsetX	0 ~ 2112	Horizontal offset from the origin to the ROI

Table 10.5 XML Parameters related to ROI

10.5 Pixel Format

The camera processes image data in the unit of 12 bit internally. You can determine the format of these image data transmitted from the camera by using the **Pixel Format** parameter.

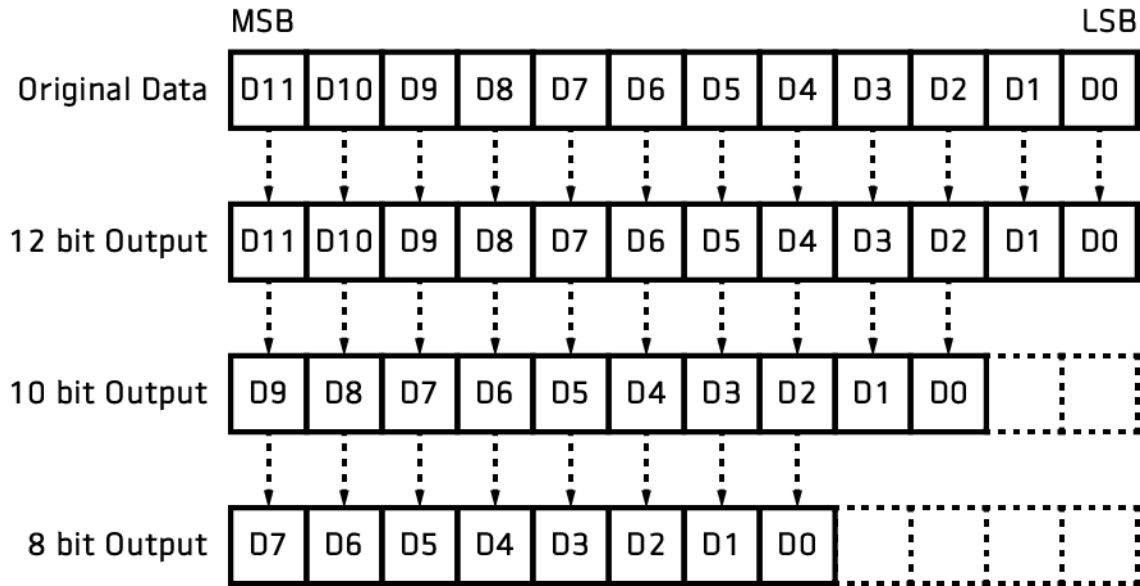

Figure 10.3 Data Format

The XML parameter related to Pixel Format is as follows.

XML Parameters		Value	Description
ImageFormatControl	PixelFormat	RGB8	Sets the pixel format to RGB 8 bit.
		RGB10	Sets the pixel format to RGB 10 bit.
		RGB12	Sets the pixel format to RGB 12 bit.
		BGR8	Sets the pixel format to BGR 8 bit.
		BGR10	Sets the pixel format to BGR 10 bit.
		BGR12	Sets the pixel format to BGR 12 bit.

Table 10.6 XML Parameter related to Pixel Format

10.6 Inter-Packet Delay

The VTC-2K10.5G camera provides the Inter-Packet Delay feature to set a delay (in nanoseconds) between packets transmitted by the camera.

Packet Size

The **DeviceStreamChannelPacketSize** parameter sets the size of the packets that the camera will use when it sends the data via the Ethernet stream channel. This parameter should always be set to the maximum size that your network components (Ethernet Adapter) can handle.



To obtain best performance from the VTC-2K10.5G camera, use of an Ethernet Adapter with a jumbo frame size of 9,000 bytes or above is strongly recommended.

Setting a Delay between Packets

The **GevSCPD** parameter sets a delay in nanoseconds between the packets transmitted from the camera. Increasing the delay will decrease the camera's effective data transmission rate and will thus decrease the network bandwidth used by the camera.

In case of multiple cameras or other devices working on the same physical network, it might be desirable to send the packets of a camera's streaming channel with a certain inter-packet delay in order to allow multiple cameras or devices to share a given network bandwidth.

XML Parameters		Value	Description
DeviceControl	DeviceStreamChannel PacketSize	576~16,000 Bytes	Sets the packet size (The maximum value may vary depending on the Ethernet Adapter.)
TransportLayerControl GigEVision	GevSCPD	0 ~ 42949679295	Sets a delay between packets.

Table 10.7 XML Parameters related to Inter-Packet Delay

10.7 Gain and Black Level

Increasing the **Gain** parameter increases all pixel values of the image. This results in a higher grey value output from the camera for a given amount of output from the image sensor.

1. Select a Gain Control parameter as desired.
2. Set the Gain parameter to the desired value.

Adjusting the **Black Level** parameter will result in an offset to the pixel values output from the camera.

1. Set the Black Level parameter to the desired value.
2. The available setting range varies depending on the Pixel Format settings.

The XML parameters related to Gain and Black Level are as follows.

XML Parameters		Value	Description
AnalogControl	AnalogGain	1×, 2×, 3×, 4×	Sets an absolute analog gain value.
	DigitalGain	1.0× ~ 8.0×	Sets an absolute digital gain value (0 dB ~ 18 dB).
	BlackLevel	-255 ~ 255	Sets a physical black level value (@ 8 bits).

Table 10.8 XML Parameters related to Gain and Black Level

10.8 White Balance

The VTC-2K10.5G camera allows you to adjust the white balance manually or automatically by setting the gain values for the Red, Green and Blue channels. To adjust the white balance manually, select a color channel by using the **Balance Ratio Selector** parameter, and then set the gain value to be applied by using the **Balance Ratio** parameter. To adjust the white balance automatically, set the **Balance White Auto** parameter to **Once**. The Balance Ratio values for the Red and Blue channels will be automatically adjusted by referring to the Green channel.

The XML parameters related to White Balance are as follows.

XML Parameters		Value	Description
AnalogControl	BalanceRatioSelector	Red	A Balance Ratio value will be applied to Red pixels.
		Green	A Balance Ratio value will be applied to Green pixels.
		Blue	A Balance Ratio value will be applied to Blue pixels.
	BalanceRatio	1.0× ~ 3.9×	Sets a Gain value to be applied to the selected color channel.
	BalanceWhiteAuto	Off	Balance White Auto Off
		Once	White Balance is adjusted once and then Off.

Table 10.9 XML parameters related to White Balance

10.9 Color Transformation

The VTC-2K10.5G camera provides the Color Transformation feature. After adjusting the white balance, you can adjust colors to your light source by using the Color Transformation feature. The Color Transformation feature converts the RGB triplet from the camera color space to the RGB triplet of the final color space when you enter nine Gain factors in the 3×3 matrix as shown below.

$$\begin{pmatrix} \mathbf{R'} \\ \mathbf{G'} \\ \mathbf{B'} \end{pmatrix} = \begin{pmatrix} \mathbf{Gain\ 00} & \mathbf{Gain\ 01} & \mathbf{Gain\ 02} \\ \mathbf{Gain\ 10} & \mathbf{Gain\ 11} & \mathbf{Gain\ 12} \\ \mathbf{Gain\ 20} & \mathbf{Gain\ 21} & \mathbf{Gain\ 22} \end{pmatrix} \times \begin{pmatrix} \mathbf{R} \\ \mathbf{G} \\ \mathbf{B} \end{pmatrix}$$

Equivalent:

$$\begin{pmatrix} \mathbf{R_{out}} \\ \mathbf{G_{out}} \\ \mathbf{B_{out}} \end{pmatrix} = \begin{pmatrix} \mathbf{RR} & \mathbf{RG} & \mathbf{RB} \\ \mathbf{GR} & \mathbf{GG} & \mathbf{GB} \\ \mathbf{BR} & \mathbf{BG} & \mathbf{BB} \end{pmatrix} \times \begin{pmatrix} \mathbf{R_{in}} \\ \mathbf{G_{in}} \\ \mathbf{B_{in}} \end{pmatrix}$$

The XML parameters related to Color Transformation are as follows.

XML Parameters		Value	Description	
ColorTransformation Control	ColorTransformationSelector	RGB to RGB	Selects a type of color transformation to be performed. RGB to RGB is the only setting available.	
	ColorTransformationEnable	-	Activates the selected color transformation.	
	ColorTransformationValue Selector	Gain00		Red contribution to the red pixel
		Gain01		Green contribution to the red pixel
		Gain02		Blue contribution to the red pixel
		Gain10		Red contribution to the green pixel
		Gain11		Green contribution to the green pixel
		Gain12		Blue contribution to the green pixel
		Gain20		Red contribution to the blue pixel
		Gain21		Green contribution to the blue pixel
		Gain22		Blue contribution to the blue pixel
	Offset0 ~ 2		Not used for RGB to RGB color transformation	
ColorTransformationValue	-4.0× ~ 4.0×	Sets a value of the selected Gain factor.		

Table 10.10 XML Parameters related to Color Transformation

10.10 LUT

The Lookup Table (LUT) feature allows you to convert original image values to certain level values.

Luminance

Since it is mapped one to one for each level value, 12 bit output can be connected to 12 bit input. The LUT is in the form of table that has 4096 entries between 0~4095 and the VTC-2K10.5G camera provides a non-volatile space for LUT data storage. You can determine whether to apply LUT. For more information about how to download LUT to the camera, refer to [Appendix B](#).

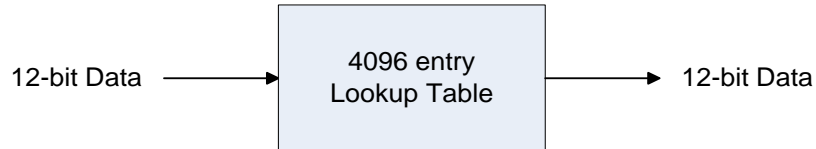

Figure 10.4 LUT Block

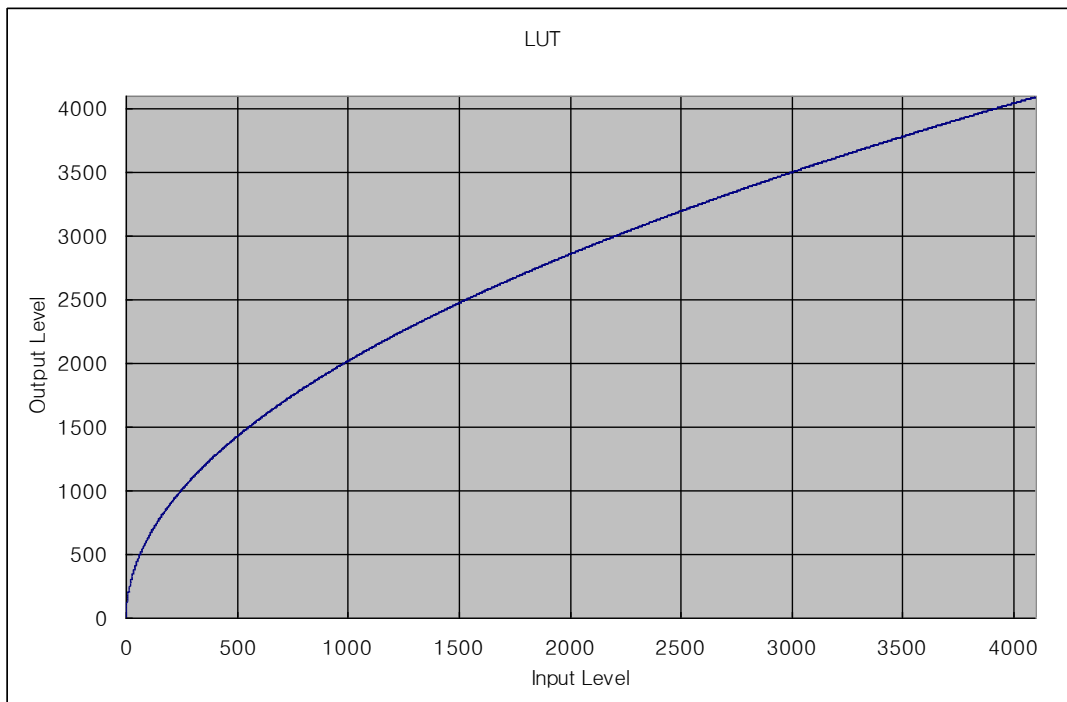

Figure 10.5 LUT at Gamma 0.5

The XML parameters related to LUT are as follows.

XML Parameters		Value	Description
LUTControl	LUTSelector	Luminance	Luminance LUT
	LUTEnable	On	Activates the selected LUT.
		Off	Deactivates the selected LUT.
	LUTIndex	0 ~ 4095	Index of coefficient for verifying the LUT value.
	LUTValue	0 ~ 4095	Output value of the current LUT corresponding to the input value of LUT Index.
	LUTSave	-	Saves the current LUT data to the non-volatile memory.
LUTLoad	-	Loads the LUT data from the non-volatile memory.	

Table 10.11 XML Parameters related to LUT

10.11 Dark Signal Non-uniformity Correction

In theory, when a digital camera acquires images in complete darkness, all of the pixel values in the image should be near zero and they should be equal. In practice, however, slight variations in the performance of the pixels in the sensor will cause some variations in the pixel values output from the camera when the camera is acquiring in darkness. This variation is known as Dark Signal Non-uniformity (DSNU). The VTC-2K10.5G camera provides the DSNU Correction feature.

The XML parameters related to DSNU are as follows.

XML Parameters		Value	Description
DSNU	DSNUGenerateAll	-	Generates and saves the DSNU data for each Analog Gain setting value (1×, 2×, 3×, 4×).
	DSNUGenerate	-	Generates the DSNU data.
	DSNUSave	-	Saves the generated DSNU data in the non-volatile memory. <ul style="list-style-type: none"> The generated data by executing the DSNUGenerate parameter are saved in the volatile memory so that the data are lost if the camera is reset or if power is turned off. To use the data after the camera is powered on or reset, save them in the non-volatile memory.
	DSNULoad	-	Loads the DSNU data from the non-volatile memory into the volatile memory.

Table 10.12 XML Parameters related to DSNU

10.11.1 Generating and Saving User DSNU Correction Values

To generate and save user DSNU correction values, use the following procedure.



For optimum DSNU correction results, we recommend that you generate DSNU data after the temperature of the camera housing has been stabilized.

1. The camera will use the entire sensor when generating DSNU correction values. Therefore, we recommend that you set the ROI settings to use the entire width of the sensor.
2. Ensure that the camera will be acquiring line images in complete darkness by covering the camera lens, closing the iris in the lens, or darkening the room.
3. Begin acquiring line images either by setting the camera for the Free-Run mode or by supplying external trigger signals to trigger line acquisitions.
4. Generate DSNU correction values.
 - Go to step 5 if you execute the **DSNU Generate** command to generate DSNU data.
 - Go to step 6 if you execute the **DSNU Generate All** command to generate DSNU data.
5. If you execute the **DSNU Generate** command,
 - a. The camera generates DSNU data according to the current Analog Gain setting value. The camera must acquire at least 4096 line images to create a set of DSNU correction values.
 - b. After completing 4096 line acquisitions, the generated DSNU correction values will be activated and saved in the camera's volatile memory.
 - c. To save the generated DSNU correction values in the camera's Flash (non-volatile) memory, execute the **DSNU Save** command. The previous DSNU values for the current Analog Gain setting value saved in the memory will be overwritten.
6. If you execute the **DSNU Generate All** command,
 - a. The camera generates the DSNU data for each Analog Gain setting values (1×, 2×, 3×, 4×) and then executes the **DSNU Save** command automatically. The camera must acquire at least 4096 line images to create sets of DSNU correction values.
 - b. After completing 4096 line acquisitions, the generated DSNU correction values according to the current Analog Gain setting value will be activated.
7. If you change the Analog Gain setting value or want to load the existing values in the Flash memory, execute the **DSNU Load** command.

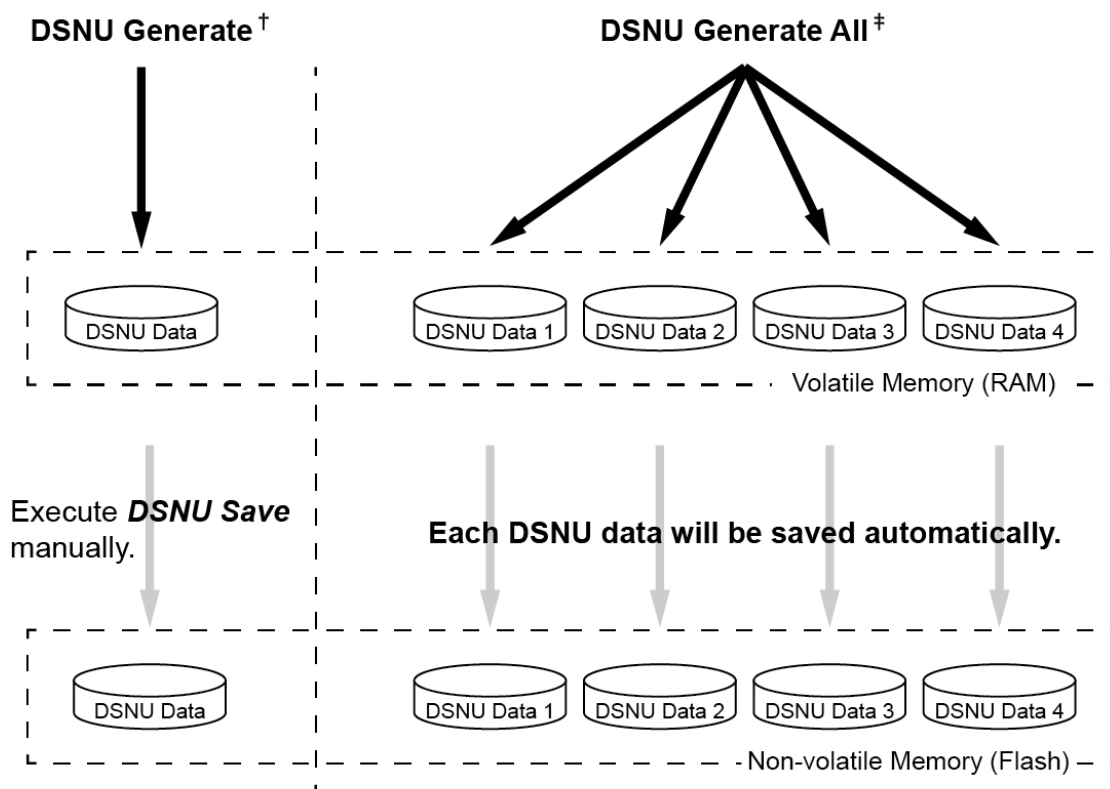

†. The camera generates **DSNU data** according to **the current Analog Gain setting**.

‡. The camera generates **four different DSNU data** according to **the Analog Gain setting values**.

Figure 10.6 Generating and Saving DSNU Correction Values

10.12 Photo Response Non-uniformity Correction

In theory, when a line scan camera acquires images with the camera viewing a uniform light-colored target in bright light, all of the pixel values in the image should be near the maximum grey value and they should be equal. In practice, however, slight variations in the performance of the pixels in the sensor, variations in the optics, and variations in the lighting will cause some variations in the pixel values output from the camera. This variation is known as Photo Response Non-uniformity (PRNU). The VTC-2K10.5G camera provides the PRNU Correction feature and five storage locations for PRNU correction values.

The XML parameters related to PRNU are as follows.

XML Parameters		Value	Description
PRNU	PRNUMode	Off	Disables the PRNU Correction feature.
		On	Enables the PRNU Correction feature.
	PRNU Selector	0/1/2/3/4	Selects a location to save PRNU data to or load PRNU data from.
	TargetLevelAUTO	-	Select to set the PRNU Target Level automatically.
	PRNUTargetLevel	0 ~ 255	Sets the PRNU Target Level (@ 8 bit pixel format).
	PRNU Generate	-	Generates the PRNU data.
	PRNUSave	-	Saves the generated PRNU data in the non-volatile memory. <ul style="list-style-type: none"> The generated data by executing the PRNUGenerate parameter are saved in the volatile memory so that the data are lost if the camera is reset or if power is turned off. To use the data after the camera is powered on or reset, save them in the non-volatile memory.
	PRNULoad	-	Loads the PRNU data from the non-volatile memory into the volatile memory.

Table 10.13 XML Parameters related to PRNU

10.12.1 Generating and Saving User PRNU Correction Values

To generate and save user PRNU correction values, use the following procedure.



- We strongly recommend that you generate new PRNU correction values whenever you make a change to the optics or lighting or if you change the camera's line rate.
- For optimum PRNU correction results, we recommend that you generate DSNU correction values first before generating PRNU correction values.

1. The camera will use the entire sensor when generating PRNU correction values. Therefore, we recommend that you set the ROI settings to use the entire width of the sensor.
2. Place a uniform white target in the field of view of the camera. Adjust the optics, lighting and line rate as you would for normal operation. We recommend that you make adjustments to achieve the digital output level in a range from 100 to 200 (Gain: 1.00 at 8 bit).
3. Begin acquiring line images either by setting the camera for the Free-Run mode or by supplying external trigger signals to trigger line acquisition.
4. Set the Target Level.
 - To set the Target Level automatically, select the **Target Level AUTO** check box.
 - To set the Target Level manually, deselect the **Target Level AUTO** check box and input the target level in a range from 0 to 255.
5. Execute the **PRNU Generate** command to generate PRNU correction values.
6. The camera must acquire at least 4096 line images to create a set of PRNU correction values.
7. After completing 4096 line acquisitions, the generated PRNU correction values will be activated and saved in the camera's volatile memory.
8. To save the generated PRNU correction values in the camera's Flash (non-volatile) memory, specify a location to save by using the **PRNU Selector** parameter and execute the **PRNU Save** command. The existing values in the memory will be overwritten.

To ignore the generated PRNU correction values and load the existing values in the Flash memory, specify a location to load from by using the **PRNU Selector** parameter and execute the **PRNU Load** command.

10.13 Reverse X

The Reverse X feature lets you flip the image horizontally. This feature is available in all operation modes.



Figure 10.7 Original Image



Figure 10.8 Reverse X Image

The XML parameter related to Reverse X is as follows.

XML Parameters		Value	Description
ImageFormatControl	Reverse X	-	Select to enable the Reverse X feature.

Table 10.14 XML Parameter related to Reverse X

10.14 Strobe Mode

The VTC-2K10.5G camera can output pulse signals through the control I/O receptacle. You can set a width of the pulse signal by using the **Strobe Mode** feature. This feature is useful when you need to supply source signal to the other device such as a Strobe Controller.

The XML parameters related to Strobe Mode are as follows.

XML Parameters		Value	Description
DigitalIOControl	StrobeMode	Off	Disables the Strobe Mode feature.
		Timed	Outputs pulse signals according to the Strobe Duration setting value.
		PulseWidth	Outputs pulse signals of which the pulse width is equal to the trigger signals applied to the camera.
		On	Outputs continuous High signals.
	StrobeInverter	-	Select to invert the output signal.
	StrobeOutDelay	0 ~ 1000.00	Sets a delay to the current output signal in microseconds.
	StrobeDuration	0 ~ 1000.00	Sets a duration of pulse signal in microseconds when the Strobe Mode is set to Timed.

Table 10.15 XML Parameters related to Strobe Mode

10.15 Device User ID

You can input user defined information up to 16 bytes.

The XML parameter related to Device User ID is as follows.

XML Parameters		Description
DeviceControl	DeviceUserID	Inputs user defined information (16 bytes).

Table 10.16 XML Parameter related to Device User ID

10.16 Device Reset

Resets the camera physically to power off and on. You must configure the connection again because the camera will be released from the connection between the camera and your computer after reset.

The XML parameter related to Device Reset is as follows.

XML Parameters		Description
DeviceControl	DeviceReset	Resets the camera physically.

Table 10.17 XML Parameter related to Device Reset

10.17 Temperature Monitor

The camera has an embedded sensor chip to monitor the internal temperature.

The XML parameter related to Device Temperature is as follows.

XML Parameters		Description
DeviceControl	DeviceTemperature	Displays device temperature in Celsius.

Table 10.18 XML Parameter related to Device Temperature

10.18 Status LED

A red/green LED is installed on the back panel of the camera to inform the operation status of the camera.

LED status and corresponding camera status are as follows.

Status LED	Descriptions
Steady Red	Camera is not initialized.
Slow Flashing Red	Gigabit Ethernet connection is not established.
Fast Flashing Orange	Camera is checking Gigabit Ethernet connection.
Steady Green	Gigabit Ethernet connection is established.
Fast Flashing Green	Camera is acquiring images.

Table 10.19 Status LED

10.19 Test Pattern

To check normal operation of the camera, it can be set to output test patterns created inside, instead of image data from the image sensor. There are three types of test pattern; image with different value in horizontal direction (Grey Horizontal Ramp), image with different value in diagonal direction (Grey Diagonal Ramp), and moving image with different value in diagonal direction (Grey Diagonal Ramp Moving).

The XML parameter related to Test Pattern is as follows.

XML Parameters		Value	Description
ImageFormatControl	TestPattern	Off	Test Pattern Off
		GreyHorizontalRamp	Sets to Grey Horizontal Ramp.
		GreyDiagonalRamp	Sets to Grey Diagonal Ramp.
		GreyDiagonalRampMoving	Sets to Grey Diagonal Ramp Moving.

Table 10.20 XML Parameter related to Test Pattern

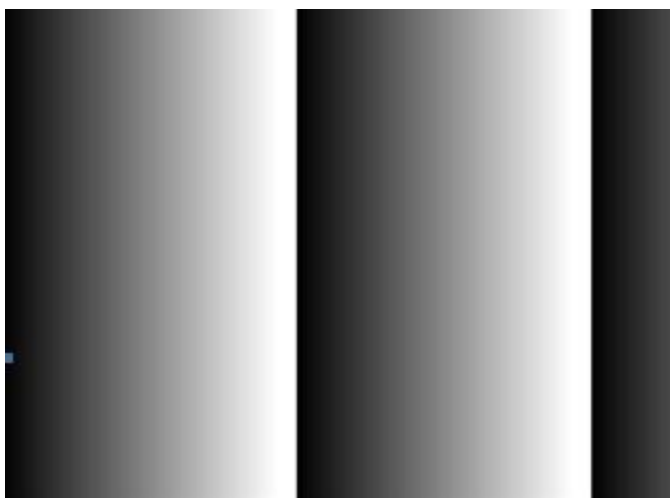

Figure 10.9 Grey Horizontal Ramp

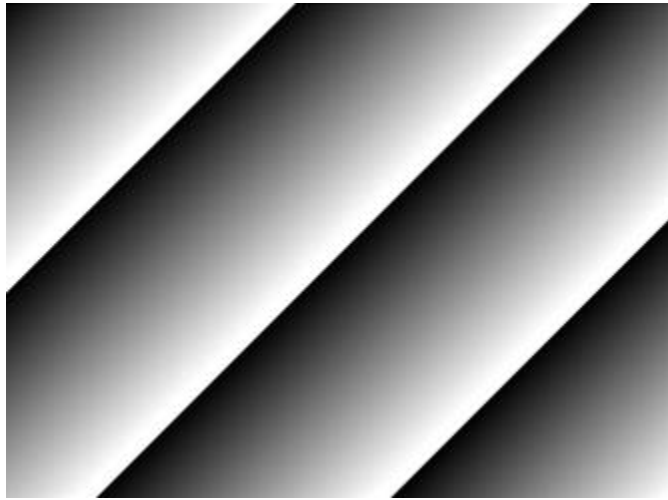

Figure 10.10 Grey Diagonal Ramp



Figure 10.11 Grey Diagonal Ramp Moving



The test pattern may look different because the region of the test pattern may vary depending on the camera's resolution.

10.20 User Set Control

You can save the current camera settings to the camera's internal ROM. You can also load the camera settings from the camera's internal ROM. The camera provides two setups to save and three setups to load settings. The XML parameters related to User Set Control are as follows.

XML Parameters	Value	Description	
UserSetControl	UserSetSelector	Default	Selects the Factory Default settings.
		UserSet1	Selects the UserSet1 settings.
		UserSet2	Selects the UserSet2 settings.
	UserSetLoad	-	Loads the User Set specified by User Set Selector to the camera.
	UserSetSave	-	Saves the current settings to the User Set specified by User Set Selector. <ul style="list-style-type: none"> The Default is Factory Default settings and allowed to load only.
	UserSetDefault	Default	Applies the Factory Default settings when reset.
		UserSet1	Applies the UserSet1 settings when reset.
		UserSet2	Applies the UserSet2 settings when reset.

Table 10.21 XML Parameters related to User Set Control

The camera settings stored in the Default can be loaded into the camera's workspace, but cannot be changed. The settings set in the workspace will be lost if the camera is reset or powered off. To use the current setting values in the workspace after a reset, you must save the settings to one of the user spaces.

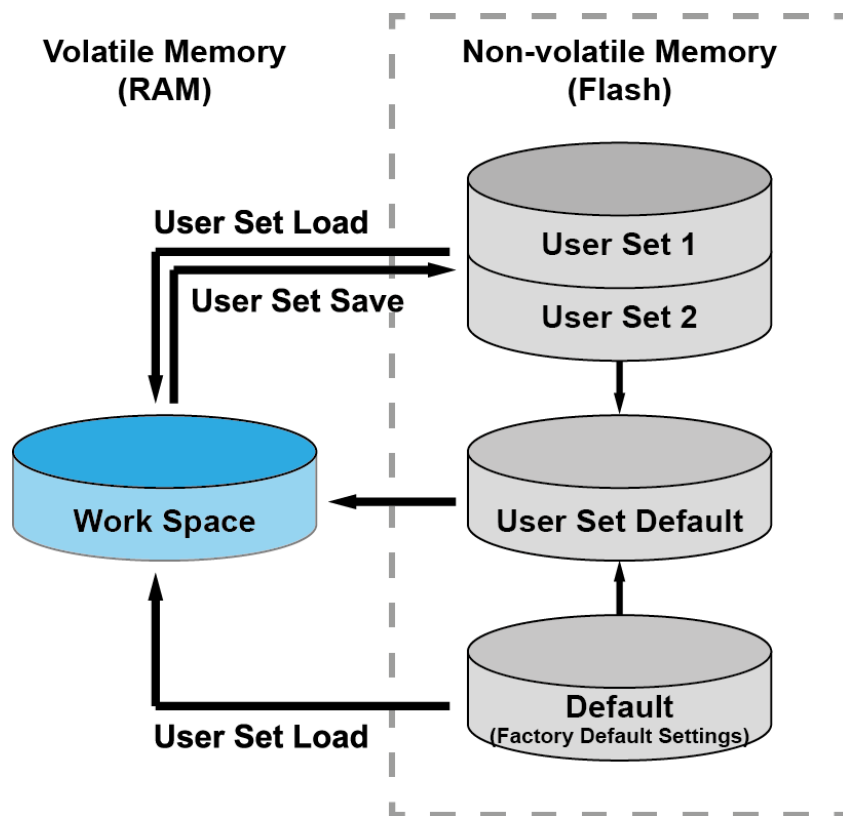

Figure 10.12 User Set Control

10.20.1 Factory Default Setting Values

When you power the camera for the first time on, the factory default setting values will be loaded into the camera and the factory default setting values are as follows:

XML Parameters	Value
Operation Mode	TDI
Scan Direction	Forward
TDI Stages	Maximum Integration Stages
Trigger Mode	Off
Test Pattern	Off
Pixel Format	RGB 8
PRNU Mode	On
DSNU Mode	On
Analog Gain	1×
Digital Gain	1×
Line Rate	10 kHz

Table 10.22 Factory Default Setting Values

10.21 Field Upgrade

The camera provides a feature to upgrade the camera's firmware and FPGA logic through the Gigabit Ethernet interface rather than disassemble the camera in the field. Refer to [Appendix A](#) for more details about how to upgrade.

11 Troubleshooting

When you have a problem with a Vieworks camera, please check the following:

- If no image is displayed on your computer,
 - Ensure that all cable connections are secure.
 - Ensure that the power supply is properly connected.
 - Ensure that trigger signals are applied correctly when you operate the camera with trigger signals.
- If images are not clear,
 - Ensure the camera lens or glass is clean.
 - Check the lens aperture is adjusted properly.
- If images are dark,
 - Ensure the camera lens is not blocked.
 - Check the line rate is set properly.
 - Check the aperture is opened properly.
 - Check the digital gain value is not set to small.
- If you identify abnormal operation or overheating sign,
 - Ensure the power supply is properly connected.
 - Stop using the camera when you notice smoke or abnormal overheating.
- If you have a problem using the Trigger Mode,
 - Ensure that cable connections are secure when you operate the camera with external trigger signals.
- If there is a communication failure between the camera and user's computer,
 - Ensure that the Gigabit Ethernet cable connection is secure.
 - Ensure that you have configured a Gigabit Ethernet card in your computer and the camera is connected to the Gigabit Ethernet card correctly.

Appendix A Field Upgrade

A.1 MCU / FPGA / XML

1. Run Vieworks Imaging Solution 7.X and click the **Configure** button to display the window as shown below.
2. Select the **PKG** tab, click the File Path button, search and select the upgrade file, and then click the **Download** button.

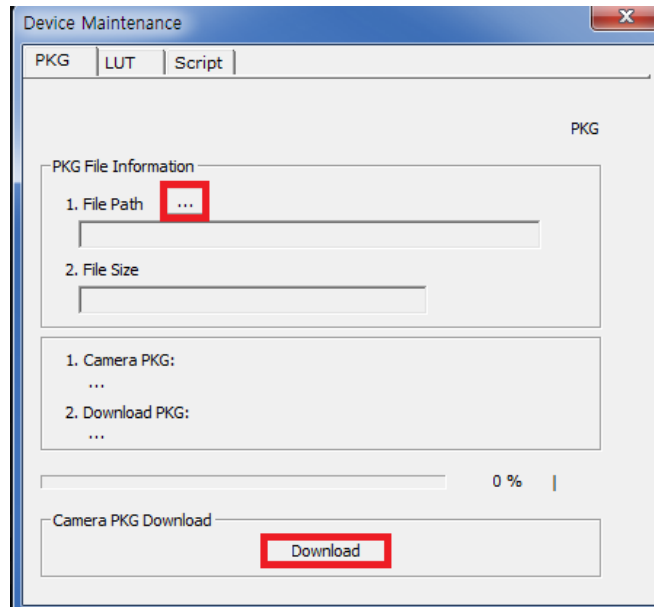

3. The upgrade file download starts, and the downloading status is displayed at the bottom of the window.

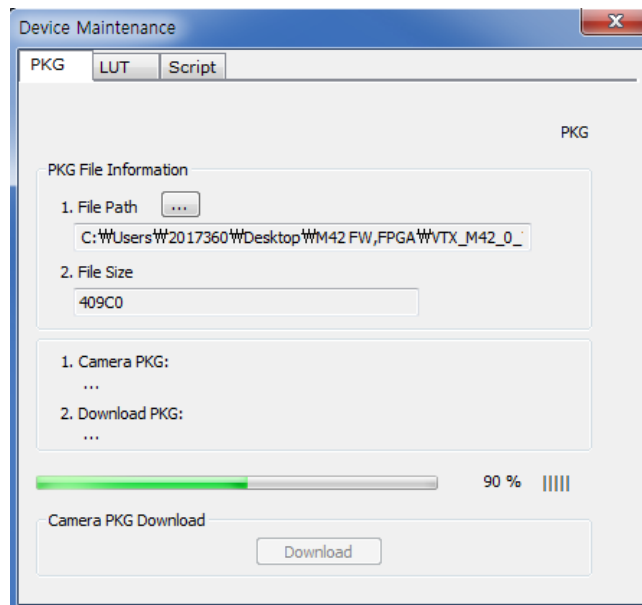

4. Once all the processes have been completed, turn the camera power off and turn it back on again.
Check the DeviceVersion parameter under the Device Control category to confirm the version.

Appendix B LUT Download

You can create LUT data in two different ways; by adjusting the gamma values on the gamma graph provided in the program and then downloading the data or by opening a CSV file (*.csv) and then downloading the data.

B.1 Gamma Graph Download

1. Run Vieworks Imaging Solution 7.X and click the **Configure** button to display the window as shown below. Select the **LUT** tab, and then select **Luminance** from the **Type** dropdown list.
2. Set a desired value in the **Gamma** input field and click the **Apply** button.

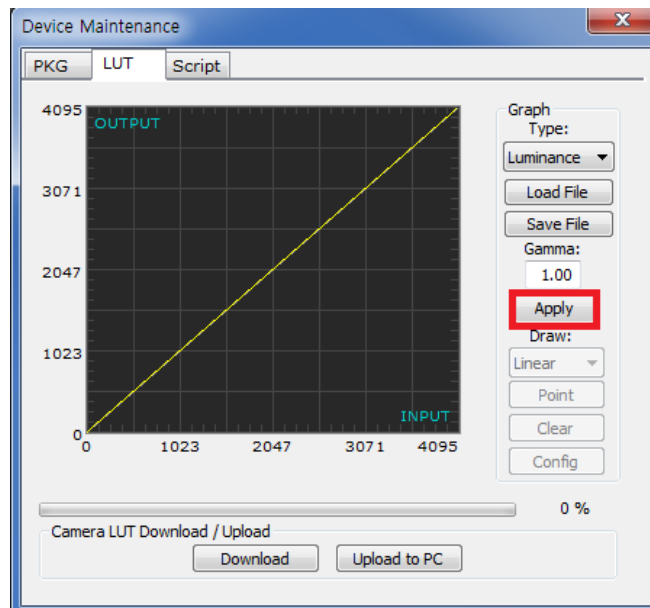

3. Click the **Download** button to download the gamma values to the camera.

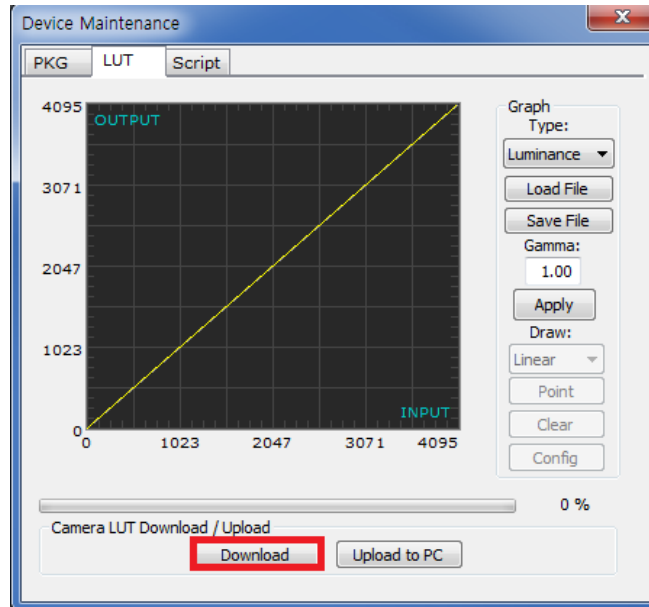

4. After completing the download, click the **OK** button to close the confirmation.

B.2 CSV File Download

1. Create the LUT table in Microsoft Excel format as shown in the left picture below and save as a CSV file (*.csv). The picture in the right shows the created file opened in Notepad. Once the file has been created completely, change the .csv file extension to .lut. Keep in mind the following rules when creating the file.
 - Lines beginning with ':' or '--' are treated as notes.
 - Based on the input values, make sure to record from 0 to 4095.

	A	B	C	D
1	:	comment line		
2	--	comment line		
3	--	input output		
4	0	4095		
5	1	4094		
6	2	4093		
7	3	4092		
8	4	4091		
9	:	:		
10	4095	0		
11				
12				
13				

```
lut - Notepad
File Edit Format View Help
: comment line,
-- comment line,
-- input,output
0,4095
1,4094
2,4093
3,4092
4,4091
: :
4095,0
```

2. Run Vieworks Imaging Solution 7.X and click the **Configure** button to display the window as shown below. Select the **LUT** tab, select **Luminance** from the **Type** dropdown list, and then click the **Load File** button.

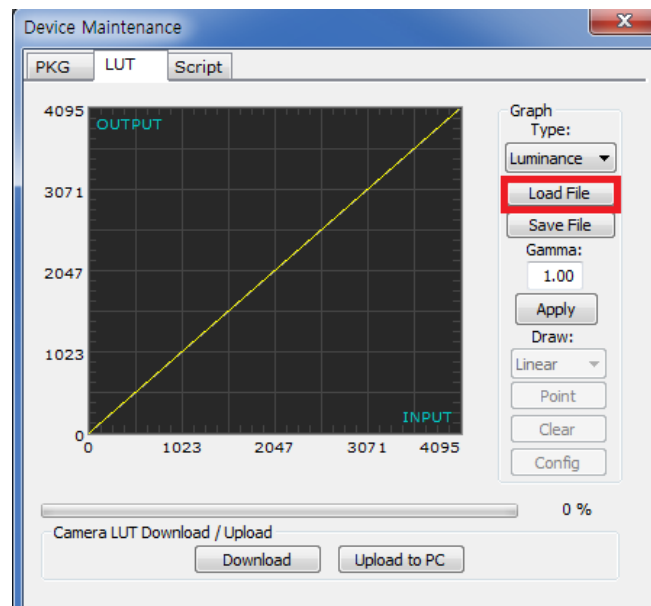

3. Search and select the created LUT file and click the **Open** button.

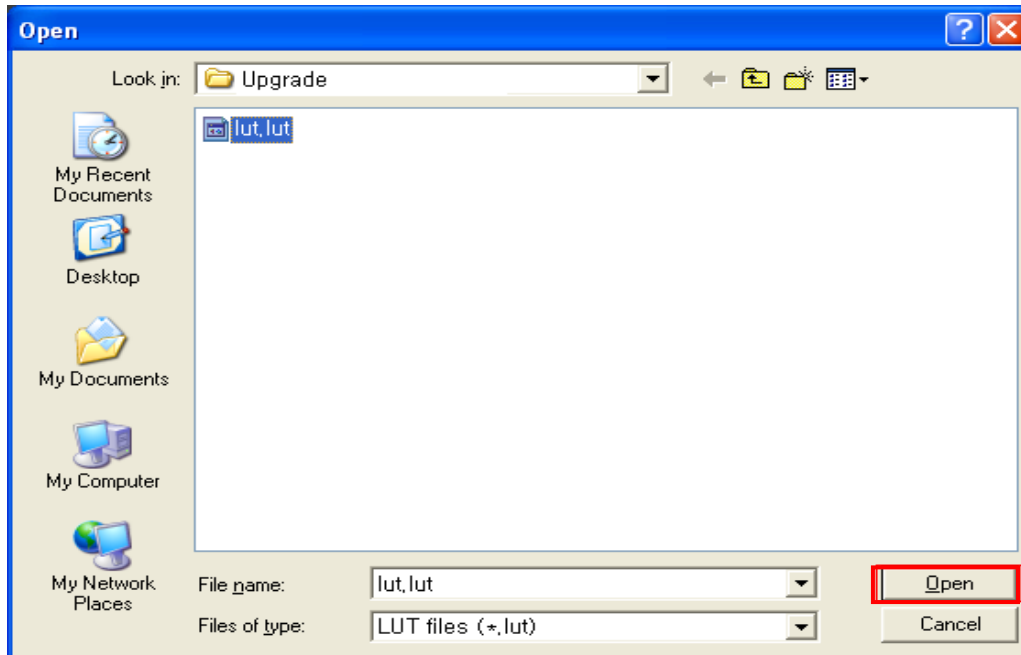

4. Click the **Download** button. After completing the download, click the **OK** button to close the confirmation.

Appendix C Correction Control

The VTC-2K10.5G camera provides an additional feature to adjust DSNU or PRNU correction values after the DSNU or PRNU Correction feature is enabled. You can specify a pixel or region of the sensor and the pixel information from the specified portion will be adjusted according to the DSNU or PRNU coefficient value.

The XML parameters related to Correction Control are as follows.

XML Parameters		Value	Description
Correction Control	StartX	-	X coordinate of a start pixel
	EndX	-	X coordinate of an end pixel
	DSNUCoef	-	Sets an additional DSNU correction value [Black Level value to be added to the specified region (DN, digital number)].
	DSNUCoefSet	-	Applies the additional DSNU correction value to the specified region.
	PRNUCoef	-	Sets an additional PRNU correction value (Gain value to be multiplied to the specified region).
	PRNUCoefSet	-	Applies the additional PRNU correction value to the specified region.
DSNU	DSNUSave	-	Saves the generated DSNU data in the non-volatile memory. <ul style="list-style-type: none"> The generated data by executing the DSNUCoefSet parameter are saved in the volatile memory so that the data are lost if the camera is reset or if power is turned off. To use the data after the camera is powered on or reset, save them in the non-volatile memory.
	DSNULoad	-	Loads the DSNU data from the non-volatile memory into the volatile memory.
PRNU	PRNUSelector	0/1/2/3/4	Selects a location to save PRNU data to or load PRNU data from.
	PRNUSave	-	Saves the generated PRNU data in the non-volatile memory. <ul style="list-style-type: none"> The generated data by executing the PRNUCoefSet parameter are saved in the volatile memory so that the data are lost if the camera is reset or if power is turned off. To use the data after the camera is powered on or reset, save them in the non-volatile memory.
	PRNULoad	-	Loads the PRNU data from the non-volatile memory into the volatile memory.

Table C.1 XML Parameters related to Correction Control

C.1 Adjusting and Saving Additional DSNU Correction Value

For example, if you want to apply -2 black level from the 100th pixel to the 109th pixel, follow the procedures below.

1. Set the **Start X** parameter to 99.
2. Set the **End X** parameter to 108.
3. Set the **DSNU Coef** parameter to -2.
4. Execute the **DSNU Coef Set** command.
5. Execute the **DSNU Save** command to save the additional DSNU correction value in the camera's Flash (non-volatile) memory. In this case, the previous DSNU values for the current Analog Gain setting value saved in the memory will be overwritten.

To ignore the adjusted DSNU correction values and load the existing values in the Flash memory, execute the **DSNU Load** command.

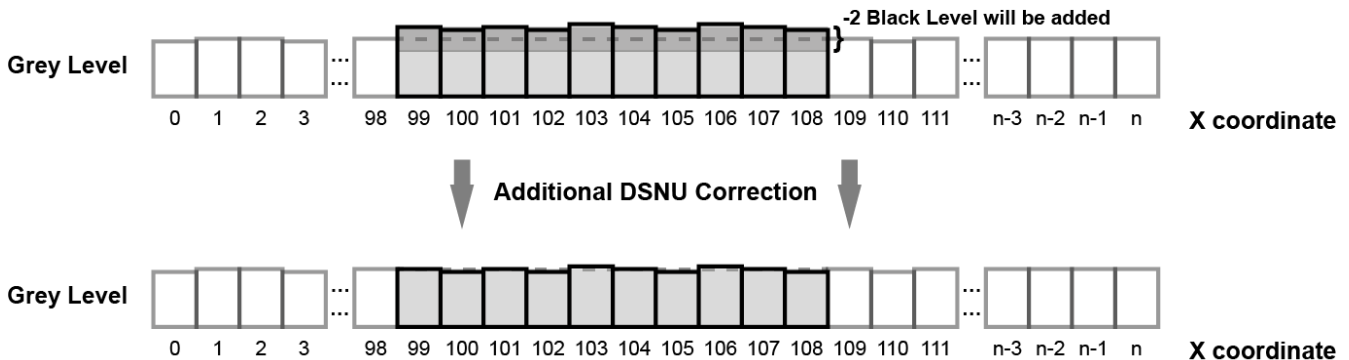

Figure C.1 Additional DSNU Correction

C.2 Adjusting and Saving Additional PRNU Correction Value

For example, if you want to apply $1.1 \times$ gain from the 100th pixel to the 109th pixel, follow the procedures below.

1. Set the **Start X** parameter to 99.
2. Set the **End X** parameter to 108.
3. Set the **PRNU Coef** parameter to 1.1.
4. Execute the **PRNU Coef Set** command.
5. Specify a location to save by using the **PRNU Selector** parameter and execute the **PRNU Save** command to save the additional PRNU correction value in the camera's Flash (non-volatile) memory. The existing values in the Flash memory will be overwritten.

To ignore the adjusted PRNU correction values and load the existing values in the Flash memory, specify a location to load from by using the **PRNU Selector** parameter and execute the **PRNU Load** command.

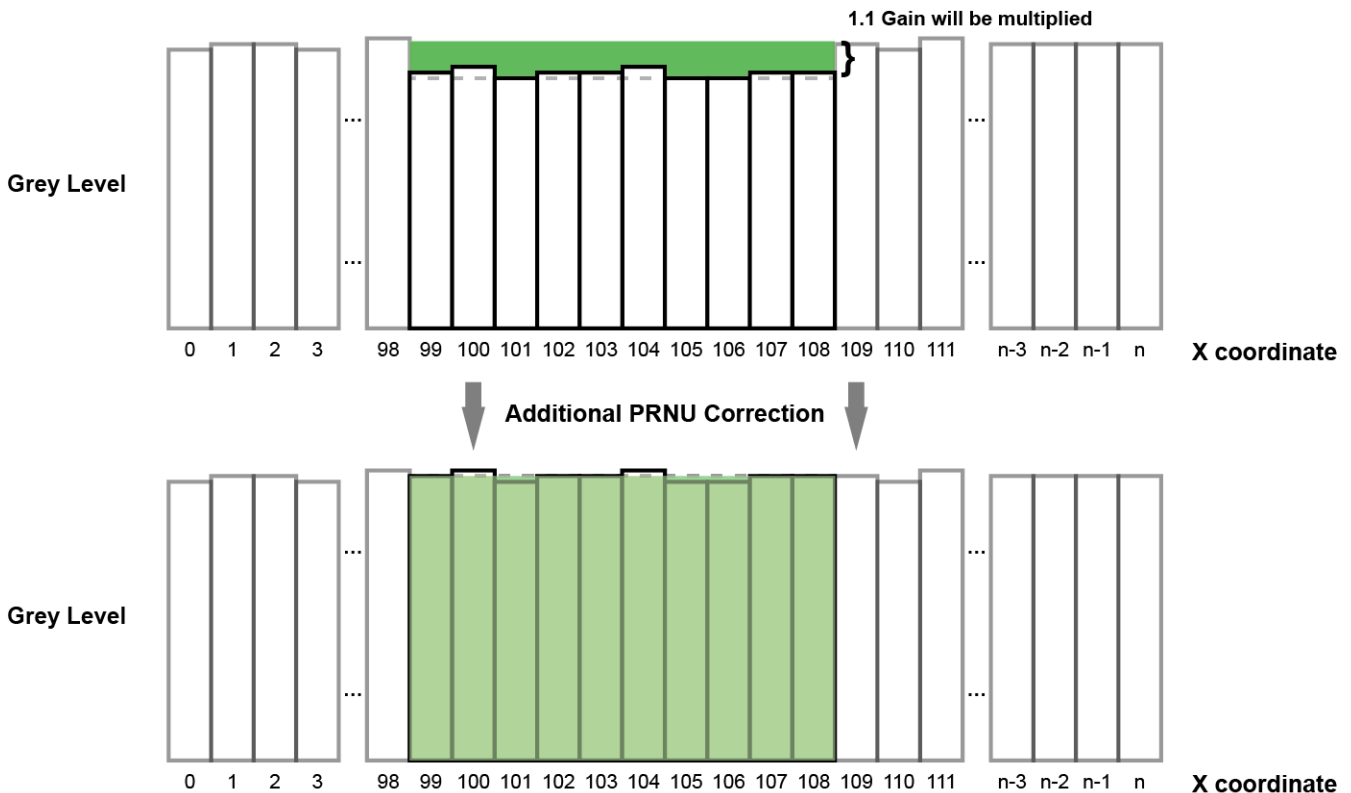
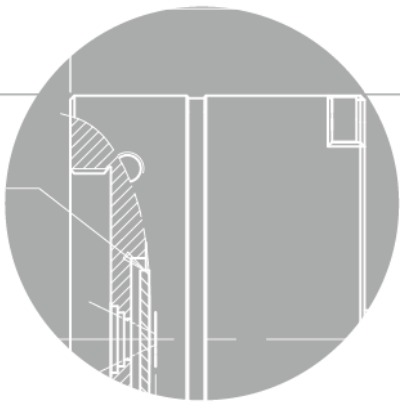
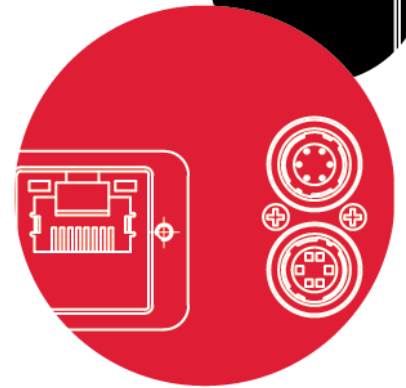
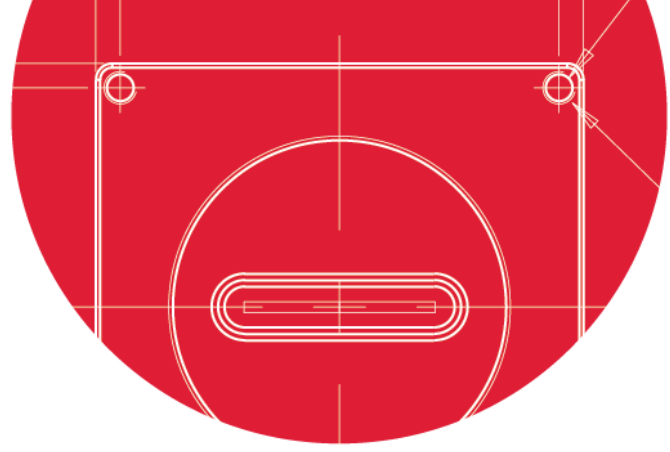

Figure C.2 Additional PRNU Correction



Before executing the **PRNU Coef Set** command, if you set the **PRNU Mode** parameter to **On**, you can determine the adjusted PRNU correction values in the acquired line images.



Vieworks Co., Ltd.

41-3, Burim-ro, 170beon-gil,
Dongan-gu, Anyang-si, Gyeonggi-do
14055 Republic of Korea

Tel: +82-70-7011-6161

Fax: +82-31-386-8631

<http://www.vieworks.com>

vision@vieworks.com