

# VC series

## User Manual

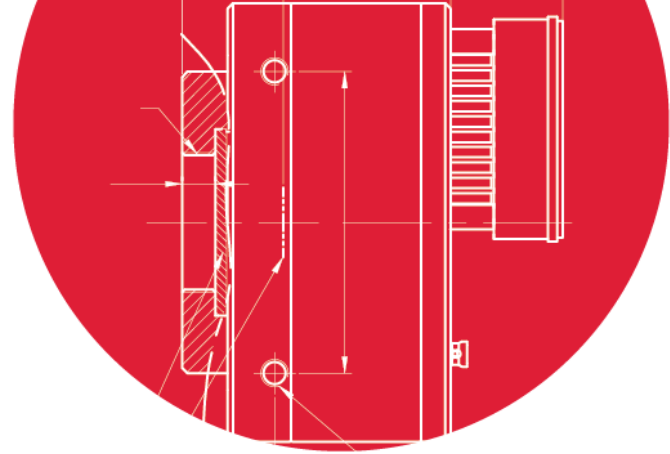

English

VC-25MX2-M/C 150I

**CoaXPress**<sup>®</sup>

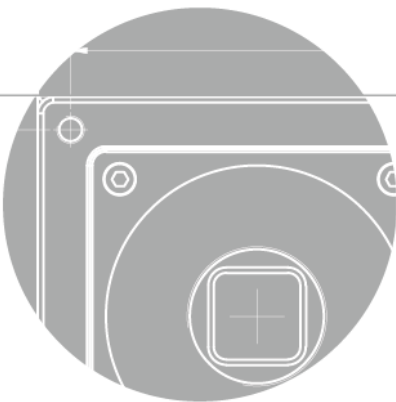

**VIEWWORKS**

**Revision History**

Revision	Date	Description
1.0	2021-01-18	Initial Release
1.1	2021-03-15	Corrected the mistyped voltage range for the trigger input (Table 7.3)

# Contents

<b>1</b>	<b>Precautions</b> .....	<b>6</b>
<b>2</b>	<b>Warranty</b> .....	<b>7</b>
<b>3</b>	<b>Compliance &amp; Certifications</b> .....	<b>7</b>
3.1	FCC Compliance.....	7
3.2	CE: DoC.....	7
3.3	KC.....	7
<b>4</b>	<b>Package Component</b> .....	<b>8</b>
<b>5</b>	<b>Product Specifications</b> .....	<b>9</b>
5.1	Overview.....	9
5.2	Specifications.....	10
5.3	Camera Block Diagram.....	11
5.4	Spectral Response.....	12
5.5	Mechanical Specification.....	13
5.5.1	Camera Mounting and Heat Dissipation.....	14
<b>6</b>	<b>Connecting the Camera</b> .....	<b>15</b>
6.1	Precaution about Blurring Compared to the Center.....	16
6.2	Installing Vieworks Imaging Solution.....	16
<b>7</b>	<b>Camera Interface</b> .....	<b>17</b>
7.1	General Description.....	17
7.2	CoaXPress Connector.....	18
7.2.1	Micro-BNC Connector.....	18
7.3	Power Input Receptacle.....	19
7.4	Control I/O Receptacle.....	20
7.5	Trigger Input Circuit.....	21
7.6	Strobe Output Circuit.....	21
<b>8</b>	<b>Acquisition Control</b> .....	<b>22</b>
8.1	Overview.....	22
8.2	Acquisition Start/Stop Commands and Acquisition Mode.....	25
8.3	Exposure Start Trigger.....	26
8.3.1	Trigger Mode.....	26
8.3.2	Using a Software Trigger Signal.....	29
8.3.3	Using a CoaXPress Trigger Signal.....	30
8.3.4	Using an External Trigger Signal.....	31
8.3.5	Exposure Mode.....	33
8.4	Setting the Exposure Time.....	35

8.5	Overlapping Exposure with Sensor Readout	36
8.6	Global Shutter	38
8.7	Maximum Allowed Frame Rate	39
8.7.1	Increasing the Maximum Allowed Frame Rate	39
<b>9</b>	<b>Camera Features</b>	<b>40</b>
9.1	Image Region of Interest	40
9.2	Multi-ROI	43
9.3	Binning	46
9.4	CXP Link Configuration	48
9.5	Pixel Format	49
9.6	Data ROI (Color Camera)	50
9.7	White Balance (Color Camera)	51
9.7.1	Balance White Auto	51
9.8	Gain and Black Level	52
9.9	Defective Pixel Correction	53
9.9.1	Correction Method	53
9.10	Dark Signal Non-uniformity Correction	54
9.10.1	Generating and Saving User DSNU Correction Values	55
9.11	Photo Response Non-uniformity Correction	56
9.11.1	Generating and Saving User PRNU Correction Values	57
9.12	Flat Field Correction	58
9.12.1	Flat Field Data Selector	61
9.13	Digital I/O Control	62
9.13.1	Debounce	64
9.14	Timer Control	65
9.15	Cooling Control	67
9.16	Temperature Monitor	68
9.17	Status LED	68
9.18	Test Pattern	69
9.19	Reverse X	72
9.20	Reverse Y	73
9.21	Device User ID	74
9.22	Device Reset	74
9.23	Field Upgrade	74
9.24	User Set Control	75
<b>10</b>	<b>Troubleshooting</b>	<b>77</b>

**Appendix A Defective Pixel Map Download .....78**  
**Appendix B Field Upgrade .....80**

# 1 Precautions

## General



- Do not drop, disassemble, repair or alter the device. Doing so may damage the camera electronics and cause an electric shock.
- Do not let children touch the device without supervision.
- Stop using the device and contact the nearest dealer or manufacturer for technical assistance if liquid such as water, drinks or chemicals gets into the device.
- Do not touch the device with wet hands. Doing so may cause an electric shock.
- Make sure that the temperature of the camera does not exceed the temperature range specified in [5.2 Specifications](#). Otherwise the device may be damaged by extreme temperatures.

## Installation and Maintenance



- Do not install in dusty or dirty areas - or near an air conditioner or heater to reduce the risk of damage to the device.
- Avoid installing and operating in an extreme environment where vibration, heat, humidity, dust, strong magnetic fields, explosive/corrosive mists or gases are present.
- Do not apply excessive vibration and shock to the device. This may damage the device.
- Avoid direct exposure to a high intensity light source. This may damage the image sensor.
- Do not install the device under unstable lighting conditions. Severe lighting change will affect the quality of the image produced by the device.
- Do not use solvents or thinners to clean the surface of the device. This can damage the surface finish.

## Power Supply



- Applying incorrect power can damage the camera. If the voltage applied to the camera is greater or less than the camera's nominal voltage, the camera may be damaged or operate erratically. Please refer to [5.2 Specifications](#) for the camera's nominal voltage.
  - ※ Vieworks Co., Ltd. does NOT provide power supplies with the device.
- Make sure the power is turned off before connecting the power cord to the camera. Otherwise damage to the camera may result.

## 2 Warranty

Do not open the housing of the camera. The warranty becomes void if the housing is opened.  
For information about the warranty, please contact your local dealer or factory representative.

## 3 Compliance & Certifications

### 3.1 FCC Compliance

This equipment has been tested and found to comply with the limits for a Class A digital device, pursuant to part 15 of the FCC Rules. These limits are designed to provide reasonable protection against harmful interference when the equipment is operated in a commercial environment. This equipment generates, uses, and can radiate radio frequency energy and, if not installed and used in accordance with the instruction manual, may cause harmful interference to radio communications. Operation of this equipment in a residential area is likely to cause harmful interference in which case the user will be required to correct the interference at his own expenses.

### 3.2 CE: DoC

EMC Directive 2014/30/EU  
EN 55032:2012 (Class A), EN 55024:2010  
Class A

### 3.3 KC

#### KCC Statement

Type	Description
Class A (Broadcasting Communication Device for Office Use)	This device obtained EMC registration for office use (Class A), and may be used in places other than home. Sellers and/or users need to take note of this.

## 4 Package Component

### Package Component

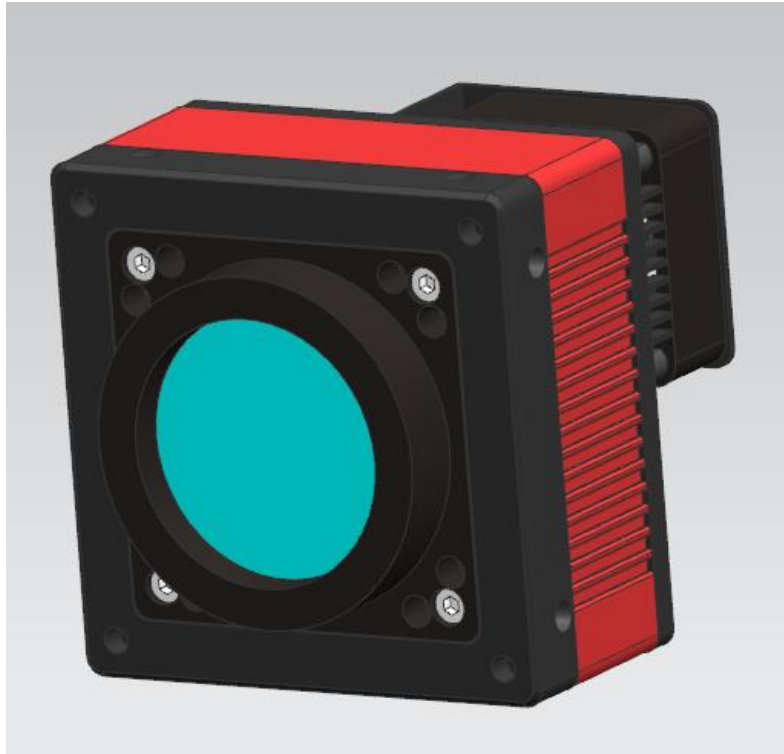

VC-25MX2-150 I with a fan



## 5 Product Specifications

### 5.1 Overview

The VC-25MX2-150 I, the latest model of the industrial proven VC series, is a new 25-megapixel CoaXPress camera and based on the CMOS global shutter image sensor technology (GMAX0505) from Gpixel.

The VC-25MX2-150 I camera offers up to 150.2 frames per second at 5,120 × 5,120 resolution. The camera comes with the next generation CoaXPress 2.0 (CXP-12) interface delivering up to 50 Gigabits per second over four coaxial cables. These combinations of the CMOS sensor technology and CoaXPress 2.0 interface set a new standard for industrial, scientific and surveillance digital imaging applications. Customers in the industrial market can take advantage of simple coax cabling to transmit images at rates and distance above and beyond previous standards. The high-speed and high-resolution camera is ideal for wide range of demanding applications such as FPD, PCB and semiconductor inspections.

#### Main Features

- High Speed 25 Megapixel CMOS Image Sensor
- CoaXPress 2.0 Interface up to 150.2 fps at 50 Gbps using 4 channels
- Power over CoaXPress (PoCXP)
- Output Channel: CXP-6 / 10 / 12 × 1 / 2 / 4
- Electronic Exposure Time Control (Global Shutter)
- Output Pixel Format: 8 / 10 bit
- Line Output
- Defective Pixel Correction
- Gain / Black Level Control
- Test Pattern
- Temperature Monitor
- Field Upgrade
- DSNU and PRNU Correction
- Flat Field Correction
- GenICam Compatible – XML based Control
- VC-25MX2-150 I Feature Bar



## 5.2 Specifications

The technical specifications of the VC-25MX2-150 I camera are as follows.

Specifications		VC-25MX2-M/C 150 I
Active Image (H × V)		5120 × 5120
Sensor		Gpixel GMAX0505
Optical Format (Diagonal)		1.1" (18.1 mm)
Pixel Size		2.5 μm × 2.5 μm
Interface		CoaXPress 2.0 (CXP-12)
Electronic Shutter		Global Shutter
Max. Frame Rate	CXP-6 × 4	93.1 fps
	CXP-10 × 4	145.6 fps
	CXP-12 × 4	150.2 fps
Pixel Data Format	Mono	Mono8 / Mono10
	Color	GB Bayer8 / GB Bayer10
Exposure Time (1 μs step)		1 μs ~ 60 s
Partial Scan (Max. Speed)		9022 fps at 4 Lines
Black Level Control		0 ~ 63 LSB at 10 bit
Gain Control		1× ~ 32×
Trigger Synchronization		Free-Run, Hardware Trigger, Software Trigger or CXP
External Trigger		3.3 V ~ 24.0 V, 10 mA, Logical level input, Optically isolated
Software Trigger		Asynchronous, Programmable via Camera API
Dynamic Range		61 dB
Lens Mount		C-mount, Custom mount available upon request
Power	External	11 ~ 24 V DC
	Dissipation	Typ. 14.0 W
	PoCXP	24 V DC, Minimum of two PoCXP cables required
Temperature		Operating: 0 ~ 40°C, Storage: -40°C ~ 70°C
Dimension / Weight		80.0 mm × 80.0 mm × 69.4 mm, 560 g (with C-mount)
API SDK		Vieworks Imaging Solution 7.X

**Table 5.1 Specifications of VC-25MX2-150 I**

## 5.3 Camera Block Diagram

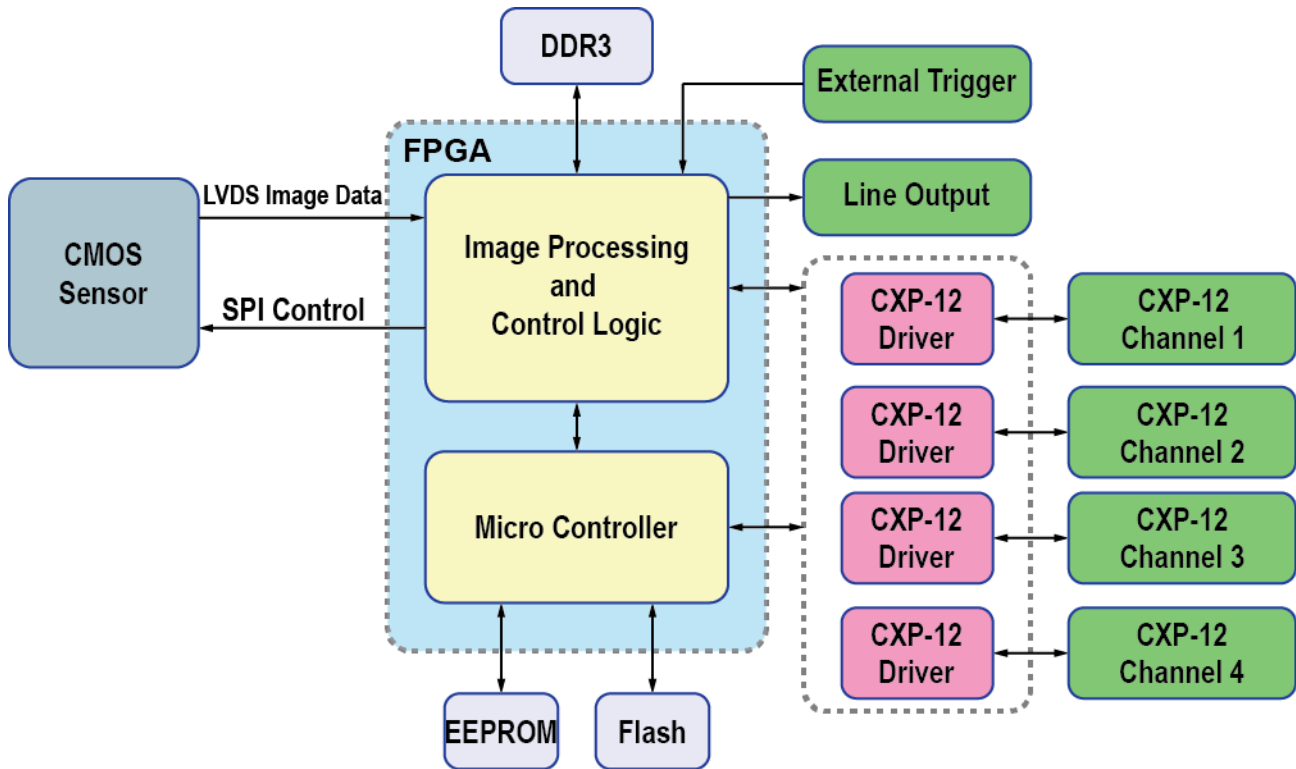

Figure 5.1 Camera Block Diagram

All controls and data processing of the camera are carried out in one FPGA chip. The FPGA generally consists of a 32-bit RISC Micro-Controller and Processing & Control logic. The Micro-Controller receives commands from the user through the CoaXPress 2.0 interface and then processes them.

The Processing & Control logic processes the image data received from the CMOS image sensor and then transmits data through the CoaXPress 2.0 interface. The Processing & Control logic also controls time-sensitive trigger inputs and output signals. Furthermore, Flash and DDR3 are installed outside FPGA. The DDR3 is used to process images and the Flash stores the firmware to operate the Micro-Controller.

## 5.4 Spectral Response

The following graphs show the spectral response of the VC-25MX2-150 I color and monochrome cameras.

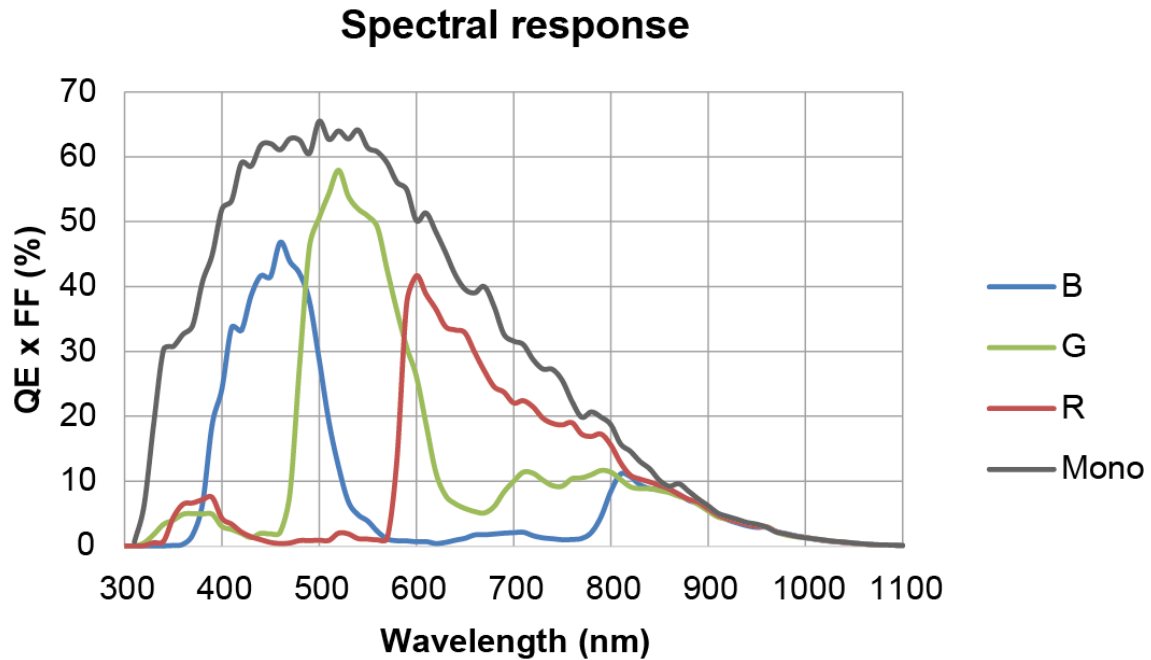

Figure 5.2 VC-25MX2-M/C150 I Spectral Response

## 5.5 Mechanical Specification

The camera dimensions in millimeters are shown in the following figure.

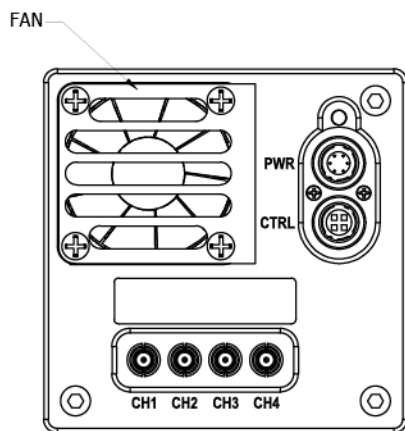
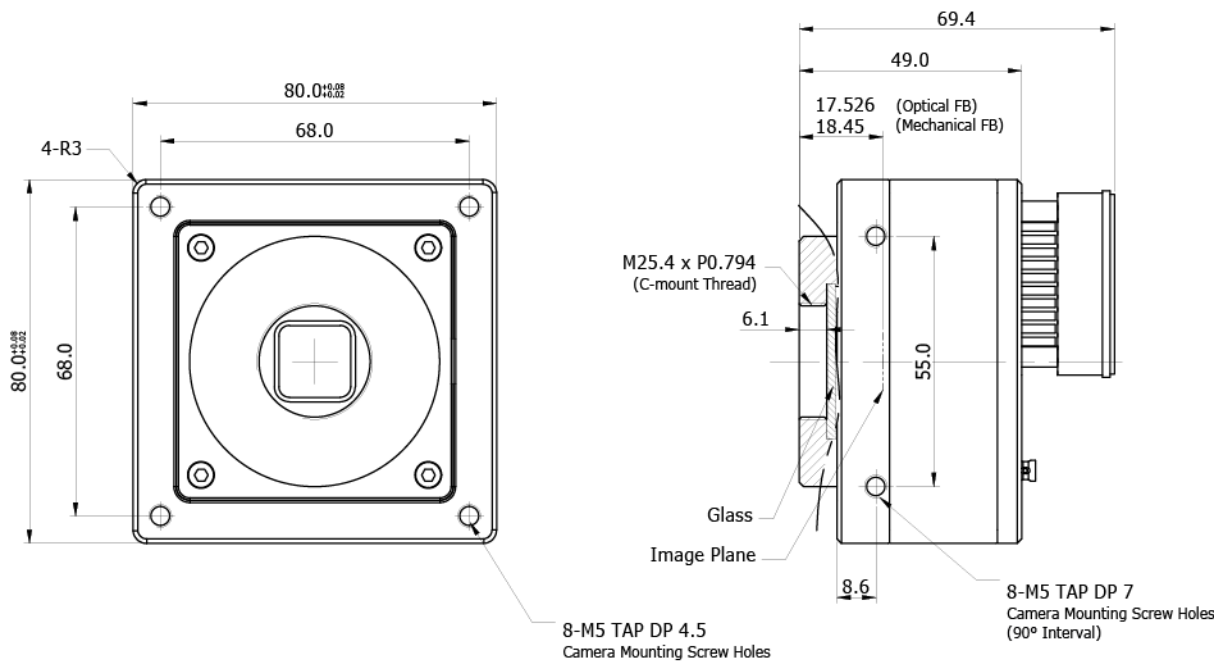

Figure 5.3 VC-25MX2-150 I C-mount Mechanical Dimension

## 5.5.1 Camera Mounting and Heat Dissipation

### Camera Mounting Recommendations for Antivibration

When you mount a camera in a poor condition, the fan equipped on the camera may amplify vibrations which can lead to blurry images. Follow the instructions below to prevent and/or reduce vibrations caused by the fan.

- Fix the camera's front or side surface by using at least four screws.
- Prevent ingress of foreign objects between the camera and system surfaces.
- Keep the camera's center of gravity as near as possible to the system's center of gravity.
- If your lens' weight or size is greater than the camera's, make and use proper mounting brackets to support the lens.
- Prevent foreign matters from falling into the fan. This may cause damage to the fan blades.

### Camera Mounting Recommendations for Effective Heat Dissipation

- Do not obstruct the air inlets and outlets of the fan.
- If the fan is not available, leave enough space around the heat sink so that heat can be easily dissipated through the heat sink by natural convection.
- If the fan is not available, mount the camera on a metal structure made of high thermal conductive materials (e.g. Aluminum) to properly dissipate the heat generated by the camera.
- The contact surface of the camera must be at least 30% of the camera's Front-Block.

## 6 Connecting the Camera

The following instructions assume that you have installed a CoaXPress 2.0 Frame Grabber (hereinafter 'CXP-12 Frame Grabber') in your computer including related software. The procedure below also assumes that you may attempt to configure a link between a camera and CXP-12 Frame Grabber by using four coax cables. For more detailed information, refer to your CXP-12 Frame Grabber User Manual.

To connect the camera to your computer, follow the steps below:

1. Make sure that the power supply is not connected to the camera and your computer is turned off.
  - Go on to step 2 if you are using a power supply.
  - Go on to step 3 if you are using a Power over CoaXPress (PoCXP) Frame Grabber.
2. **If you are using a power supply:**
  - a. Plug one end of a coax cable into the CH1 of the CXP connector on the camera and the other end of the coax cable into the CH1 of the CXP-12 Frame Grabber in your computer. Then, connect the CH2, CH3 and CH4 of the CXP connector on the camera to the CH2, CH3 and CH4 of the CXP-12 Frame Grabber respectively using the other three coax cables.
  - b. Connect the plug of the power adapter to the power input receptacle on the camera.
  - c. Plug the power adapter into a working electrical outlet.
3. **If you are using a PoCXP Frame Grabber:**
  - a. Plug one end of a coax cable into the CH1 of the CXP connector on the camera and the other end of the coax cable into the CH1 of the CXP-12 Frame Grabber in your computer. Then, connect the CH2, CH3 and CH4 of the CXP connector on the camera to the CH2, CH3 and CH4 of the CXP-12 Frame Grabber respectively using the other three coax cables.
  - b. You must connect both the CH1 and CH2 channels to power the camera via PoCXP.
4. Verify all the cable connections are secure.

### Precautions for using Power over CoaXPress



To power a camera via PoCXP Frame Grabber, you must connect both the CH1 and CH2 channels of the camera to their respective connectors on the CXP-12 Frame Grabber.

## 6.1 Precaution about Blurring Compared to the Center

- Users do not need to adjust the tilt as it is adjusted as factory default settings.
- If the tilt settings need to be adjusted inevitably, please contact your local dealer or factory representative for technical support.

## 6.2 Installing Vieworks Imaging Solution

You can download the Vieworks Imaging Solution at <http://www.vieworks.com>. You should perform the software installation first and then the hardware installation.



## 7 Camera Interface

### 7.1 General Description

As shown in the following figure, three types of connectors and an LED indicator are located on the back of the camera and have the functions as follows:

- ① Status LED: displays power status and operation mode.
- ② 6 pin Power Input Receptacle: supplies power to the camera (if PoCXP is not used).
- ③ 4 pin Control I/O Receptacle: provides access to the camera's I/O lines.
- ④ CoaXPress Connector: transmits video data and controls the camera.

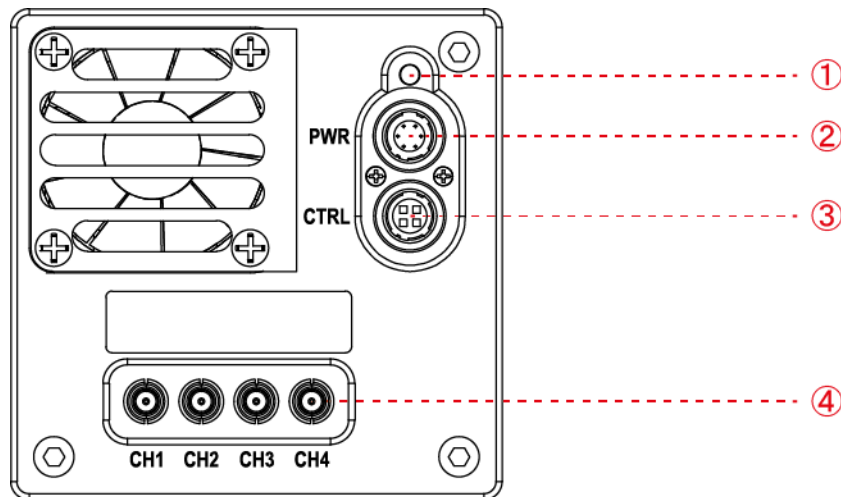

Figure 7.1 VC-25MX2-150 I with Micro-BNC Connectors

## 7.2 CoaXPress Connector

CoaXPress protocol includes an automatic link detection mechanism (Plug and Play) to correctly detect the camera to the CXP-12 Frame Grabber connection. The connection between the camera and CXP-12 Frame Grabber uses a coax (also known as 'coaxial') cable and provides up to 12.5 Gbps bit rate per cable.

The VC-25MX2-150 I camera can be powered over the cable if you are using a PoCXP enabled Frame Grabber.

### 7.2.1 Micro-BNC Connector

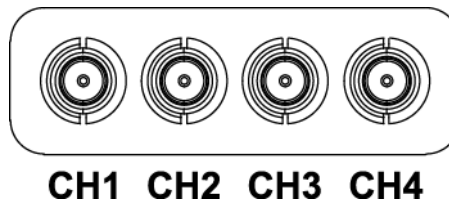

Figure 7.2 Micro-BNC Connector

The CoaXPress connectors on the VC-25MX2-150 I camera comply with the CoaXPress 2.0 standard and the following table shows the channel assignments.

Channel	Max. Bit Rate per Coax	Type	PoCXP Compliant
CH1	12.5 Gbps	Master Connection	Yes
CH2	12.5 Gbps	Extension Connection	Yes
CH3	12.5 Gbps	Extension Connection	No
CH4	12.5 Gbps	Extension Connection	No

Table 7.1 Channel Assignments for Micro-BNC Connector



When you connect a camera to a CXP-12 Frame Grabber using coax cables, make sure to connect the cables to their correct channels. If you connect the CH1 of the CXP connector on the camera to a channel other than CH1 of the CXP-12 Frame Grabber, the camera may not transmit images properly or the communication between the computer and camera may fail.

## 7.3 Power Input Receptacle

The power input receptacle is a Hirose 6-pin connector (part # HR10A-7R-6PB). The pin assignments and configurations are as follows:

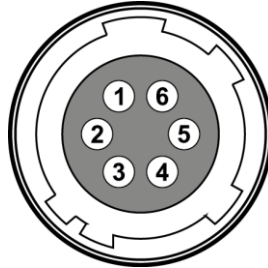

Figure 7.3 Pin Assignments for Power Input Receptacle

Pin Number	Signal	Type	Description
1, 2, 3	+12 V DC	Input	DC Power Input
4, 5, 6	DC Ground	Input	DC Ground

Table 7.2 Pin Configurations for Power Input Receptacle



- A recommended mating connector for the Hirose 6-pin connector is the Hirose 6-pin plug (part # HR10A-7P-6S) or the equivalent.
- It is recommended that you use the power adapter, which has at least 3 A current output at 11 – 24 V voltage output (You need to purchase a power adapter separately).

### Precaution for Power Input



- Make sure the power is turned off before connecting the power cord to the camera. Otherwise, damage to the camera may result.
- If the voltage applied to the camera is greater than specified in the specifications, damage to the camera may result.

## 7.4 Control I/O Receptacle

The Control I/O Receptacle is a Hirose 4-pin connector (part # HR10A-7R-4S) and consists of an external trigger signal input and strobe output ports. The pin assignments and configurations are as follows:

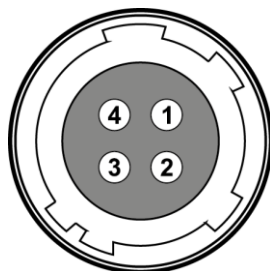

Figure 7.4 Pin Assignments for Control I/O Receptacle

Pin Number	Signal	Type	Description
1	Trigger Input+	Input	3.3 V ~ 24.0 V TTL input
2	Trigger Input-	Input	-
3	DC Ground	-	DC Ground
4	Line1 Output	Output	3.3 V TTL output Output resistance: 47 $\Omega$

Table 7.3 Pin Configurations for Control I/O Receptacle



A recommended mating connector for the Hirose 4-pin connector is the Hirose 4-pin plug (part # HR10A-7P-4P) or the equivalent.

## 7.5 Trigger Input Circuit

The following figure shows trigger signal input circuit of the 4-pin connector. Transmitted trigger signal is applied to the internal circuit through a photo coupler. With the Debounce feature, you can specify the width of input signal to be considered as a valid input signal. An external trigger circuit example is shown below.

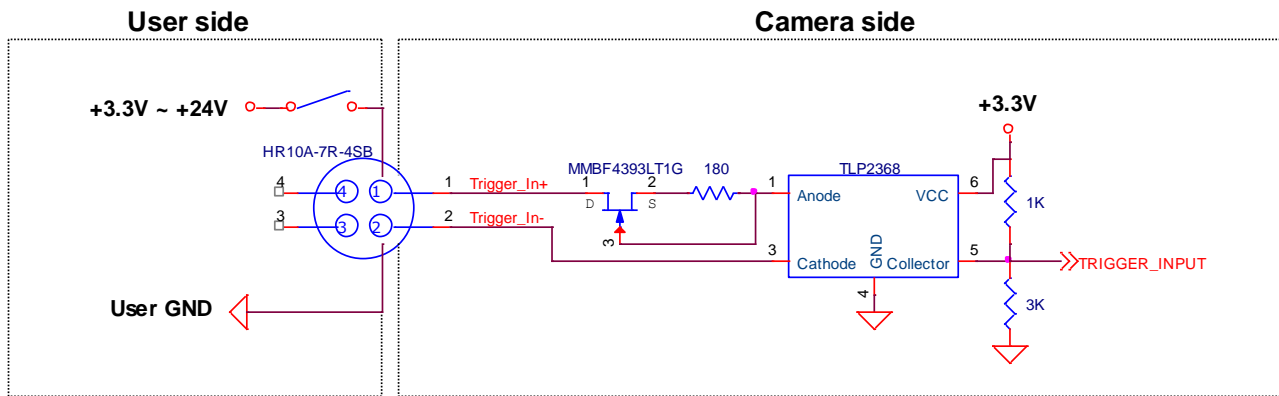

Figure 7.5 Trigger Input Schematic

## 7.6 Strobe Output Circuit

The strobe output signal comes out through a 3.3 V output level of TTL Driver IC. A pulse width of signal is synchronized with an exposure (shutter) signal of the camera.

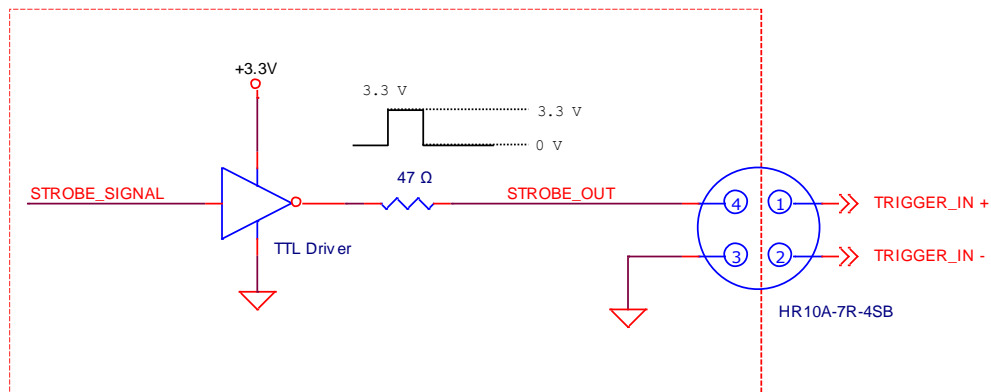

Figure 7.6 Strobe Output Schematic

## 8 Acquisition Control

This chapter provides detailed information about controlling image acquisition.

- Triggering image acquisition
- Setting the exposure time
- Controlling the camera's image acquisition rate
- Variation of the camera's maximum allowed image acquisition rate according to the camera settings

### 8.1 Overview

This section presents an overview of the elements involved with controlling the acquisition of images.

Three major elements are involved in controlling the acquisition of images.

- **Acquisition Start** and **Acquisition Stop** commands and the **Acquisition Mode** parameter
- Exposure start trigger
- Exposure time control



When reading the explanations in the overview and in this entire chapter, keep in mind that the term **frame** is typically used to mean a single acquired image.

#### Acquisition Start and Stop Commands and Acquisition Mode

The **Acquisition Start** command prepares the camera to acquire frames. The camera cannot acquire frames unless an **Acquisition Start** command has first been executed.

A parameter called the **Acquisition Mode** has a direct bearing on how the **Acquisition Start** command operates. The VC-25MX2-150 I camera only supports **Continuous** for the **Acquisition Mode** parameter. If the **Acquisition Mode** parameter is set to **Continuous**, an **Acquisition Start** command does not expire after a single frame is acquired. Once an **Acquisition Start** command has been executed, you can acquire as many frames as you like. The **Acquisition Start** command will remain in effect until you execute an **Acquisition Stop** command. Once an **Acquisition Stop** command has been executed, the camera will not be able to acquire frames until a new **Acquisition Start** command is executed.

## Exposure Start Trigger

Applying an exposure start trigger signal to the camera will exit the camera from the *waiting for exposure start trigger* acquisition status and will begin the process of exposing and reading out a frame (see Figure 8.1).

As soon as the camera is ready to accept another exposure start trigger signal, it will return to the *waiting for exposure start trigger* acquisition status. A new exposure start trigger signal can then be applied to the camera to begin another frame exposure. The exposure start trigger has two modes: off and on.

If the **Trigger Mode** parameter is set to **Off**, the camera will generate all required exposure start trigger signals internally, and you do not need to apply exposure start trigger signals to the camera. The rate at which the camera will generate the signals and acquire frames will be determined by the way that you set several frame rate related parameters.

If the **Trigger Mode** parameter is set to **On**, you must trigger exposure start by applying exposure start trigger signals to the camera. Each time a trigger signal is applied, the camera will begin a frame exposure. When exposure start is being triggered in this manner, it is important that you do not attempt to trigger frames at a rate that is greater than the maximum allowed (There is a detailed explanation about the maximum allowed frame rate at the end of this chapter.). Exposure start trigger signals applied to the camera when it is not in a *waiting for exposure start trigger* acquisition status will be ignored.

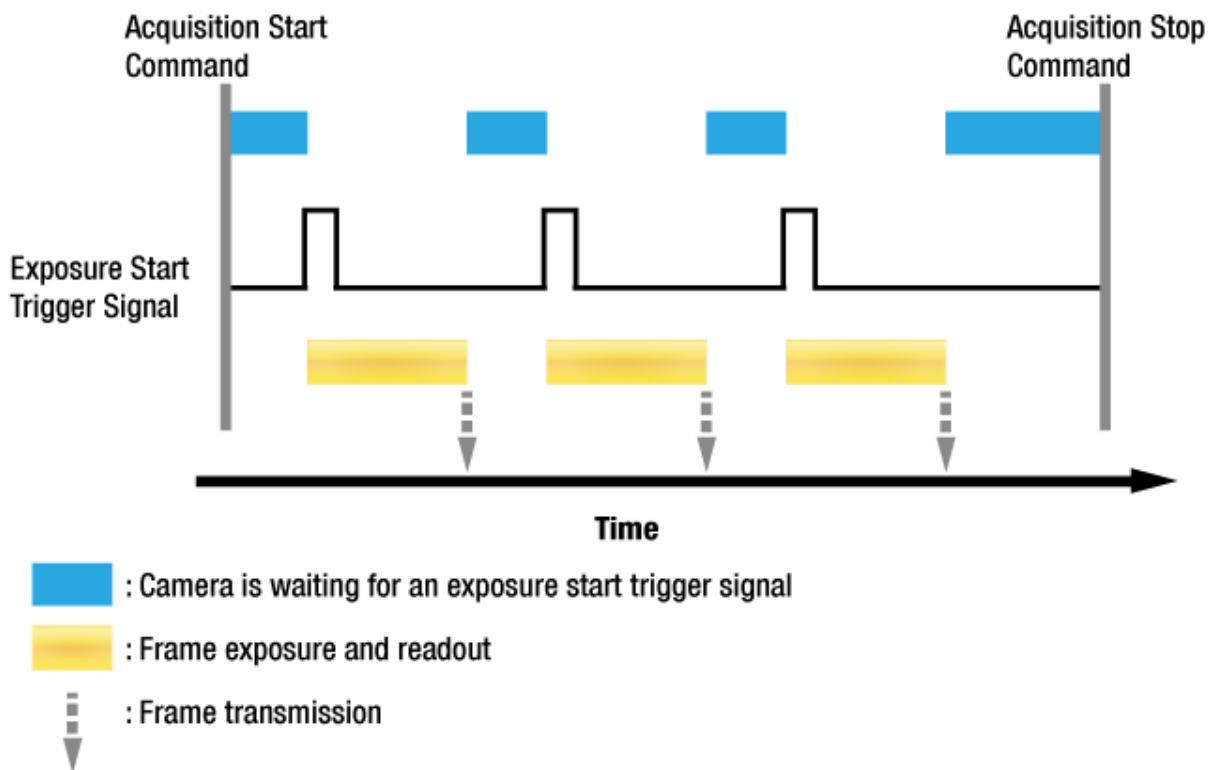

Figure 8.1 Exposure Start Triggering

## Applying Trigger Signals

The paragraphs above mention “applying a trigger signal”. There are five ways to apply an exposure start trigger signal to the camera: via **Software**, via **User Output0**, via **Link Trigger0**, via **Timer0 Active** or via **Line0** (commonly referred to a hardware).

- To apply trigger signals via **Software**, you must set the **Trigger Source** parameter to **Software**. At that point, each time a **Trigger Software** command is executed, the exposure start trigger signal will be applied to the camera.
- To apply trigger signals via **User Output0**, you must set the **Trigger Source** parameter to **User Output0**. At that point, you can apply an exposure start trigger signal to the camera by switching the **User Output Value** parameter between **On** (rise) and **Off** (fall).
- To apply trigger signals via CH1 of the CXP-12 Frame Grabber, you must set the **Trigger Source** parameter to **Link Trigger0**. At that point, each time a proper CoaXPress trigger signal is applied to the camera by using the APIs provided by a CXP-12 Frame Grabber manufacturer, the exposure start trigger signal will be applied to the camera. For more information, refer to your CXP-12 Frame Grabber User Manual.
- To apply trigger signals via the user-defined Timer feature, you must set the **Trigger Source** parameter to **Timer0 Active**. When you set the **Timer Trigger Source** parameter to **Line0** in the **Counter And Timer Control** category, you can apply an exposure start trigger signal to the camera by using a Timer that uses the Line0 signal as the source signal.
- To apply trigger signals via hardware (external), you must set the **Trigger Source** parameter to **Line0**. At that point, each time a proper electrical signal is applied to the camera, an occurrence of the exposure start trigger signal will be recognized by the camera.

## Exposure Time Control

When an exposure start trigger signal is applied to the camera, the camera will begin to acquire a frame.

A critical aspect of frame acquisition is how long the pixels in the camera’s sensor will be exposed to light during the frame acquisition.

If the **Trigger Source** parameter is set to **Software**, the **Exposure Time** parameter will determine the exposure time for each frame.

If the **Trigger Source** parameter is set to **User Output0**, **Link Trigger0**, **Timer0 Active** or **Line0**, there are two modes of operation: **Timed** and **Trigger Width**.

With the **Timed** mode, the **Exposure Time** parameter will determine the exposure time for each frame.

With the **Trigger Width** mode, the way that you manipulate the rise and fall of the User Output, CoaXPress, Timer or hardware (external) signal will determine the exposure time. The **Trigger Width** mode is especially useful if you want to change the exposure time from frame to frame.



## 8.2 Acquisition Start/Stop Commands and Acquisition Mode

Executing an **Acquisition Start** command prepares the camera to acquire frame. You must execute an **Acquisition Start** command before you can begin acquiring frames.

Executing an **Acquisition Stop** command terminates the camera's ability to acquire frames.

When the camera receives an **Acquisition Stop** command:

- If the camera is not in the process of acquiring a frame, its ability to acquire frames will be terminated immediately.
- If the camera is in the process of acquiring a frame, the frame acquisition process will be allowed to finish and the camera's ability to acquire new frames will be terminated.

The **Acquisition Status** parameter allows you to check whether the camera is in the process of acquiring a frame or not. When you read the **Acquisition Status** parameter while the camera is in the process of acquiring a frame, it will return True or the check box will be selected. When you read the **Acquisition Status** parameter while the camera is not in the process of acquiring a frame, it will return False or the check box will not be selected.



When you execute the **Acquisition Start** command while the previous frame acquisition process is still in progress, the command will be ignored. To avoid this, you must wait until the camera completes the frame acquisition process after the execution of the **Acquisition Stop** command. Then, you can safely execute the **Acquisition Start** command again.

The VC-25MX2-150 I camera only provides the **Continuous** mode of operation for the **Acquisition Mode**. After an **Acquisition Start** command has been executed, exposure start can be triggered as desired. Each time an exposure start trigger is applied while the camera is in a *waiting for exposure start trigger* acquisition status, the camera will acquire and transmit a frame. The camera will retain the ability to acquire frames until an **Acquisition Stop** command is executed. Once the **Acquisition Stop** command is received, the camera will no longer be able to acquire frames.

## 8.3 Exposure Start Trigger

The **Trigger Selector** parameter is used to select a type of trigger and only the **Exposure Start** trigger is available on the VC-25MX2-150 I camera. The Exposure Start trigger is used to begin frame acquisition. Exposure start trigger signals can be generated within the camera or may be applied externally by setting the **Trigger Source** parameter to **Software**, **User Output0**, **Link Trigger0**, **Timer0 Active** or **Line0**. If an exposure start trigger signal is applied to the camera, the camera will begin to expose a frame.

### 8.3.1 Trigger Mode

The main parameter associated with the exposure start trigger is the **Trigger Mode** parameter. The **Trigger Mode** parameter for the exposure start trigger has two available settings: **Off** and **On**.

#### 8.3.1.1 Trigger Mode = Off

When the **Trigger Mode** parameter is set to **Off**, the camera will generate all required exposure start trigger signals internally, and you do not need to apply exposure start trigger signals to the camera.

If the **Trigger Mode** parameter is set to **Off**, the camera will automatically begin generating exposure start trigger signals when it receives an **Acquisition Start** command. The camera will continue to generate exposure start trigger signals until it receives an **Acquisition Stop** command.



#### Free Run

When you set the **Trigger Mode** parameter to **Off**, the camera will generate all required trigger signals internally. When the camera is set this way, it will constantly acquire images without any need for triggering by the user. This use case commonly referred as “free run”.

The rate at which the exposure start trigger signals are generated may be determined by the camera's **Acquisition Frame Rate** parameter.

- If the parameter is set to a value less than the maximum allowed frame rate with the current camera settings, the camera will generate exposure start trigger signals at the rate specified by the parameter setting.
- If the parameter is set to a value greater than the maximum allowed frame rate with the current camera settings, the camera will generate exposure start trigger signals at the maximum allowed frame rate.

#### Exposure Time Control with Trigger Mode = Off

When the **Trigger Mode** parameter is set to **Off**, the exposure time for each frame acquisition is determined by the value of the camera's **Exposure Time** parameter. For more information about the Exposure Time parameter, see [8.4 Setting the Exposure Time](#).

### 8.3.1.2 Trigger Mode = On

When the **Trigger Mode** parameter is set to **On**, you must apply an exposure start trigger signal to the camera each time you want to begin a frame acquisition. The **Trigger Source** parameter specifies the source signal that will act as the exposure start trigger signal.

The available settings for the **Trigger Source** parameter are:

- **Software:** You can apply an exposure start trigger signal to the camera by executing a **Trigger Software** command for the exposure start trigger on your computer.
- **User Output0:** You can apply an exposure start trigger signal to the camera by switching the **User Output Value** parameter between **On** and **Off** on your computer.
- **Link Trigger0:** You can apply an exposure start trigger signal via CH1 of the CXP-12 Frame Grabber. For more information, refer to your CXP-12 Frame Grabber User Manual.
- **Timer0Active:** You can apply an exposure start trigger signal to the camera using a user defined Timer signal. When you set the **Timer Trigger Source** parameter to **Line0** in the **Counter And Timer Control** category, you can specify a delay for the Line0 signal by using the **Timer Delay** parameter. For more information, refer to [9.14 Timer Control](#).
- **Line0:** You can apply an exposure start trigger signal to the camera by injecting an externally generated electrical signal (commonly referred to as a hardware or external trigger signal) into the Control I/O receptacle on the camera. Refer to [7.5 Trigger Input Circuit](#) for more information.

You must also set the **Trigger Activation** parameter after setting the **Trigger Source** parameter.

The available settings for the **Trigger Activation** parameter are:

- **Falling Edge:** Specifies that a falling edge of the electrical signal will act as the exposure start trigger.
- **Rising Edge:** Specifies that a rising edge of the electrical signal will act as the exposure start trigger.

## Exposure Time Control with Trigger Mode = On

When the **Trigger Mode** parameter is set to **On** and the **Trigger Source** parameter is set to **Software**, the exposure time for each frame acquisition is determined by the value of the camera's **Exposure Time** parameter.

When the **Trigger Mode** parameter is set to **On** and the **Trigger Source** parameter is set to **Link Trigger0** or **Line0**, the exposure time for each frame acquisition will be determined by the **Exposure Mode** parameter settings as follows:

- **Exposure Mode = Timed:** Exposure time can be controlled with the **Exposure Time** parameter.
- **Exposure Mode = Trigger Width:** Exposure time can be controlled by manipulating the external trigger signal.

When the **Trigger Mode** parameter is set to **On** and the **Trigger Source** parameter is set to **Timer0 Active**, the exposure time for each frame acquisition will be determined by the **Exposure Mode** parameter settings as follows:

- **Exposure Mode = Timed:** Exposure time can be controlled with the **Exposure Time** parameter.
- **Exposure Mode = Trigger Width:** When you set the **Timer Trigger Activation** parameter to **Rising/Falling Edge**, the exposure time is controlled with the **Timer Duration** parameter. When you set the **Timer Trigger Activation** parameter to **Level High/Low**, the exposure time can be controlled by manipulating the external trigger signal.

When the **Trigger Mode** parameter is set to **On** and the **Trigger Source** parameter is set to **User Output0**, the exposure time for each frame acquisition will be determined by the **Exposure Mode** parameter settings as follows:

- **Exposure Mode = Timed:** Exposure time can be controlled with the **Exposure Time** parameter.
- **Exposure Mode = Trigger Width:** Exposure time can be controlled by switching the **User Output Value** parameter between **On** and **Off**.

### 8.3.2 Using a Software Trigger Signal

If the **Trigger Mode** parameter is set to **On** and the **Trigger Source** parameter is set to **Software**, you must apply a software trigger signal (exposure start) to the camera to begin each frame acquisition. Assuming that the camera is in a *waiting for exposure start trigger* acquisition status, frame exposure will start when the software trigger signal is received by the camera. Figure 8.2 illustrates frame acquisition with a software trigger signal. When the camera receives a software trigger signal and begins exposure, it will exit the *waiting for exposure start trigger* acquisition status because at that point, it cannot react to a new exposure start trigger signal. As soon as the camera is capable of reacting to a new exposure start trigger signal, it will automatically return to the *waiting for exposure start trigger* acquisition status. The exposure time for each acquired frame will be determined by the value of the camera's **Exposure Time** parameter.

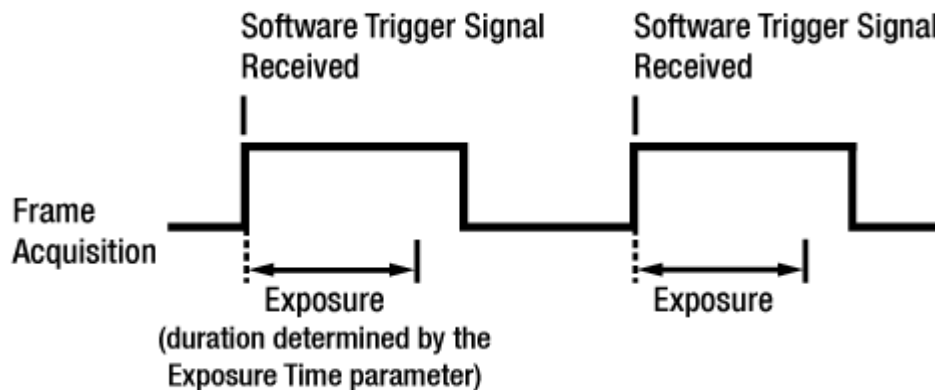

**Figure 8.2 Frame Acquisition with Software Trigger Signal**

When you are using a software trigger signal to start each frame acquisition, the frame rate will be determined by how often you apply a software trigger signal to the camera, and you should not attempt to trigger frame acquisition at a rate that exceeds the maximum allowed for the current camera settings (There is a detailed explanation about the maximum allowed frame rate at the end of this chapter.). Software trigger signals that are applied to the camera when it is not ready to receive them will be ignored.

### 8.3.3 Using a CoaXPress Trigger Signal

If the **Trigger Mode** parameter is set to **On** and the **Trigger Source** parameter is set to **Link Trigger0**, you must apply a CoaXPress trigger signal to the camera to begin each frame acquisition. A CoaXPress trigger signal will act as the exposure start trigger signal for the camera. For more information, refer to your CXP-12 Frame Grabber User Manual.

A rising edge or a falling edge of the CoaXPress signal can be used to trigger frame acquisition. The **Trigger Activation** parameter is used to select rising edge or falling edge triggering.

Assuming that the camera is in a *waiting for exposure start trigger* acquisition status, frame acquisition will start whenever the appropriate edge transition is received by the camera.

When the camera receives a CoaXPress trigger signal and begins exposure, it will exit the *waiting for exposure start trigger* acquisition status because at that point, it cannot react to a new exposure start trigger signal.

As soon as the camera is capable of reacting to a new exposure start trigger signal, it will automatically return to the *waiting for exposure start trigger* acquisition status.

When the camera is operating under control of a CoaXPress signal, the period of the CoaXPress trigger signal will determine the rate at which the camera is acquiring frames:

$$\frac{1}{\text{CoaXPress signal period in seconds}} = \text{Frame Rate}$$

For example, if you are operating a camera with a CoaXPress trigger signal period of 50 ms (0.05 s):

So in this case, the frame rate is 20 fps.

### 8.3.4 Using an External Trigger Signal

If the **Trigger Mode** parameter is set to **On** and the **Trigger Source** parameter is set to **Line0**, an externally generated electrical signal injected into the Control I/O receptacle will act as the exposure start trigger signal for the camera. This type of trigger signal is generally referred to as a hardware trigger signal.

A rising edge or a falling edge of the external signal can be used to trigger frame acquisition. The **Trigger Activation** parameter is used to select rising edge or falling edge triggering.

Assuming that the camera is in a *waiting for exposure start trigger* acquisition status, frame acquisition will start whenever the appropriate edge transition is received by the camera.

When the camera receives an external trigger signal and begins exposure, it will exit the *waiting for exposure start trigger* acquisition status because at that point, it cannot react to a new exposure start trigger signal.

As soon as the camera is capable of reacting to a new exposure start trigger signal, it will automatically return to the *waiting for exposure start trigger* acquisition status.

When the camera is operating under control of an external signal, the period of the external trigger signal will determine the rate at which the camera is acquiring frames:

$$\frac{1}{\text{External signal period in seconds}} = \text{Frame Rate}$$

For example, if you are operating a camera with an External trigger signal period of 50 ms (0.05 s):

So in this case, the frame rate is 20 fps.

### 8.3.4.1 External Trigger Delay

When you set the **Trigger Source** parameter to **Timer0Active**, you can specify a delay between the receipt of a hardware trigger signal and when the trigger becomes effective.

1. Set the **Timer Trigger Source** parameter in the **Counter And Timer Control** category to **Line0**.
2. Set the **Timer Delay** parameter to the desired Timer delay in microseconds.
3. Set the **Trigger Source** parameter in the **Acquisition Control** category to **Timer0Active**.
4. Execute the **Acquisition Start** command and inject an externally generated electrical signal into the Control I/O receptacle. Then, the delay set by the **Timer Delay** parameter expires and the exposure for image acquisition begins.

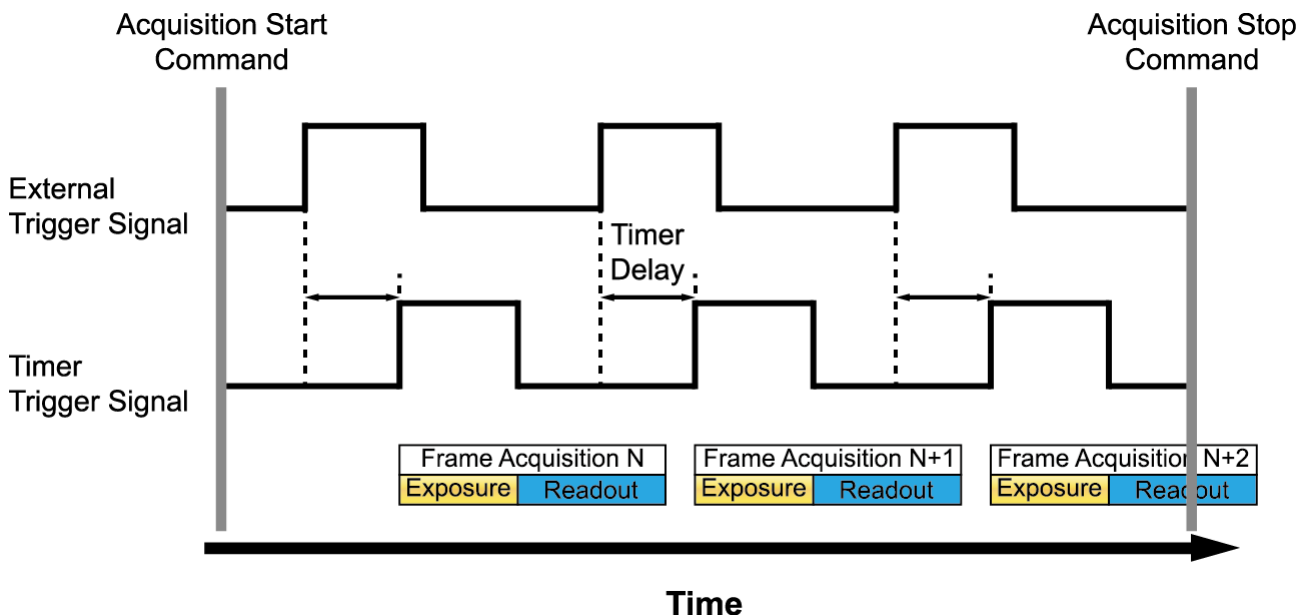

Figure 8.3 External Trigger Delay



### 8.3.5 Exposure Mode

If you are triggering the start of frame acquisition with an externally (CoaXPress or External) generated trigger signal, two exposure modes are available: **Timed** and **Trigger Width**.

#### Timed Exposure Mode

When the **Timed** mode is selected, the exposure time for each frame acquisition is determined by the value of the camera's **Exposure Time** parameter. If the camera is set for rising edge triggering, the exposure time starts when the external trigger signal rises. If the camera is set for falling edge triggering, the exposure time starts when the external trigger signal falls. The following figure illustrates **Timed** exposure with the camera set for rising edge triggering.

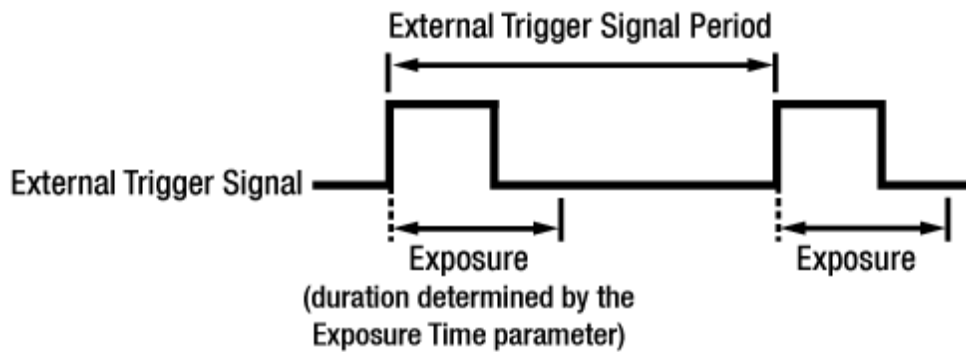

Figure 8.4 Timed Exposure Mode

Note that if you attempt to trigger a new exposure start while the previous exposure is still in progress, the trigger signal will be ignored.

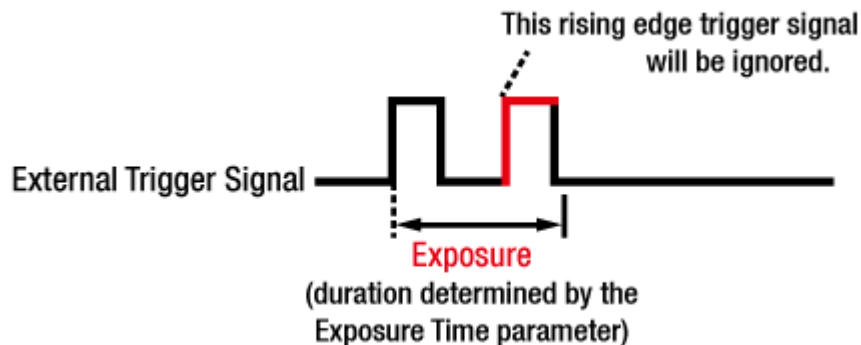

Figure 8.5 Trigger Overlapped with Timed Exposure Mode

## Trigger Width Exposure Mode

When the **Trigger Width** exposure mode is selected, the length of the exposure for each frame acquisition will be directly controlled by the external trigger signal (CoaXPress or External). If the camera is set for rising edge triggering, the exposure time begins when the external trigger signal rises and continues until the external trigger signal falls. If the camera is set for falling edge triggering, the exposure time begins when the external trigger signal falls and continues until the external trigger signal rises. The following figure illustrates **Trigger Width** exposure with the camera set for rising edge triggering.

**Trigger Width** exposure is especially useful if you intend to vary the length of the exposure time for each frame.

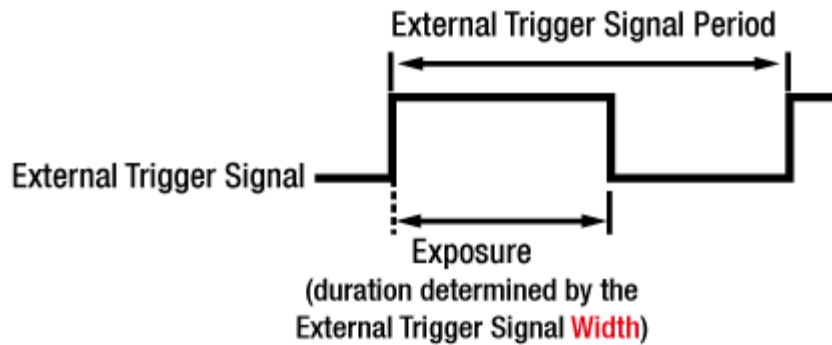

Figure 8.6 Trigger Width Exposure Mode

## 8.4 Setting the Exposure Time

This section describes how the exposure time can be adjusted manually by setting the value of the **Exposure Time** parameter. If you are operating the camera in any one of the following ways, you must specify an exposure time by setting the camera's **Exposure Time** parameter.

- the **Trigger Mode** is set to **Off**.
- the **Trigger Mode** is set to **On** and the **Trigger Source** is set to **Software**.
- the **Trigger Mode** is set to **On**, the **Trigger Source** is set to **User Output0, Link Trigger0, Timer0 Active** or **Line0**, and the **Exposure Mode** is set to **Timed**.

The **Exposure Time** parameter must not be set below a minimum specified value. The **Exposure Time** parameter sets the exposure time in microseconds ( $\mu s$ ). The minimum and maximum exposure time settings for the VC-25MX2-150 I camera are shown in the following table.

Camera Model	Number of Channels	Minimum Exposure Time	Maximum Exposure Time †
VC-25MX2-150 I	1 / 2 / 4 Channel	1 $\mu s$	60,000,000 $\mu s$

†: When the **Exposure Mode** is set to **Trigger Width**, the exposure time is controlled by the external trigger signal and has no maximum limit.

**Table 8.1 Minimum and Maximum Exposure Time Setting**

## 8.5 Overlapping Exposure with Sensor Readout

The frame acquisition process on the camera includes two distinct parts. The first part is the exposure of the pixels in the image sensor. Once exposure is complete, the second part of the process – readout of the pixel values from the sensor – takes place. In regard to this frame acquisition process, the VC-25MX2-150 I camera basically operates with ‘overlapped’ exposure so that the exposure for a new frame can be overlapped with the sensor readout for the previous frame.

When a new trigger signal is applied to the camera while reading out the previous frame, the camera begins the process of exposing a new frame. This situation is illustrated in the following figure with the **Trigger Mode** set to **On**, the **Trigger Source** set to **Line0** and the **Exposure Mode** set to **Trigger Width**.

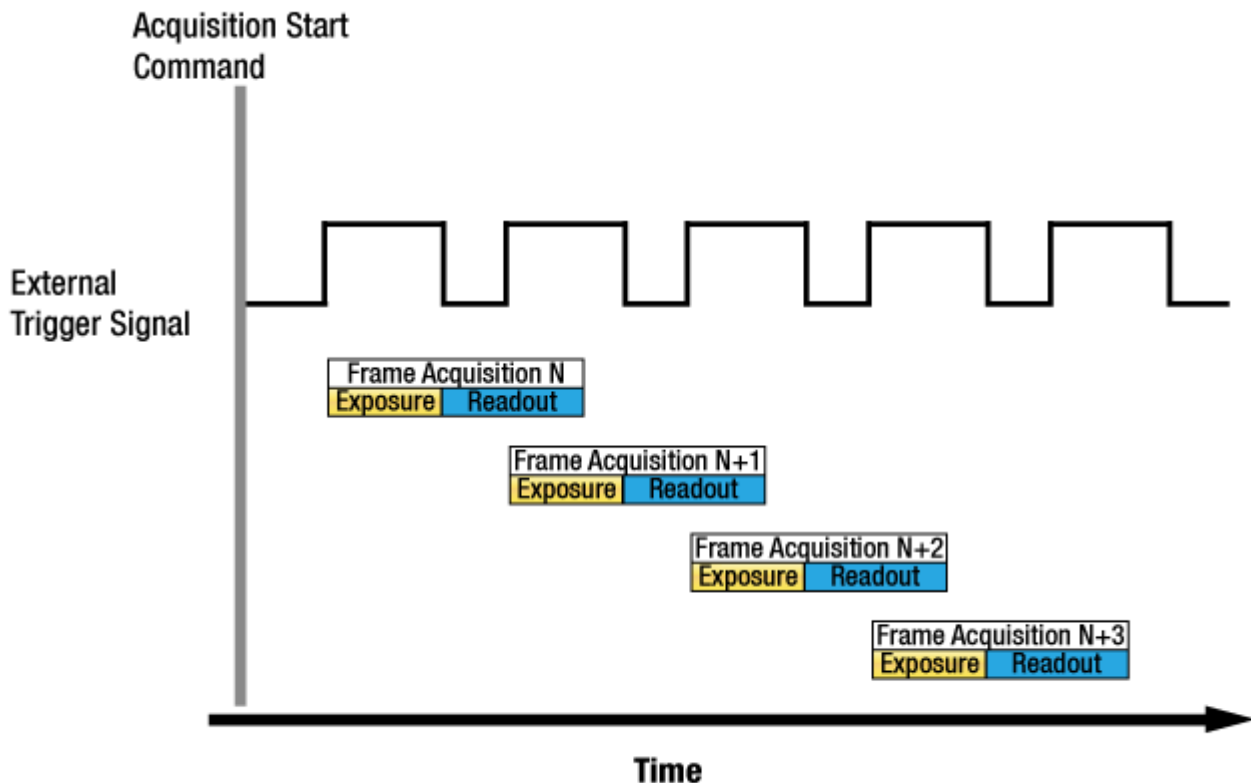

Figure 8.7 Overlapped Exposure and Readout

Determining whether your camera is operating with overlapped exposure and readout is not a matter of issuing a command or changing a setting. Rather a way that you operate the camera will determine whether the exposures and readouts are overlapped or not. If we define the “Frame Period” as the time from the start of exposure for one frame acquisition to the start of exposure for the next frame acquisition, then:

- Overlapped:  $\text{Frame Period} \leq \text{Exposure Time} + \text{Readout Time}$

## Guidelines for Overlapped Exposure

Since the VC-25MX2-150 I camera operates with overlapped exposure, you must keep in mind two important guidelines:

- You must not begin the exposure for a new frame while the exposure for the previous frame is in progress.
- You must not end the exposure for the current frame until the readout for the previous frame is complete.

When you are operating the camera with overlapped exposure and using an external trigger signal to trigger image acquisition, you could use the camera's Exposure Time parameter settings and timing formula to calculate when it is safe to begin each new acquisition.

## 8.6 Global Shutter

The VC-25MX2-150 I camera is equipped with an image sensor that has an electronic global shutter. When an exposure start trigger signal is applied to the camera equipped with a global shutter, exposure begins for all lines in the sensor as shown in the figure below. Exposure continues for all lines in the sensor until the programmed exposure time ends or when the exposure start trigger signal ends the exposure time if the camera is using the trigger width exposure mode. At the end of the exposure time, exposure ends for all lines in the sensor.

Immediately after the end of exposure, pixel data readout begins and proceeds line by line until all pixel data is read out of the sensor. A main characteristic of a global shutter is that for each frame acquisition, all of the pixels in the sensor start exposing at the same time and all end exposing at the same time. This means that image brightness tends to be more uniform over the entire area of each acquired image, and it helps to minimize problems with acquiring images of object in motion.

The camera can provide an **Exposure Active** output signal that will go high when the exposure time for a frame acquisition begins and will go low when the exposure time ends.

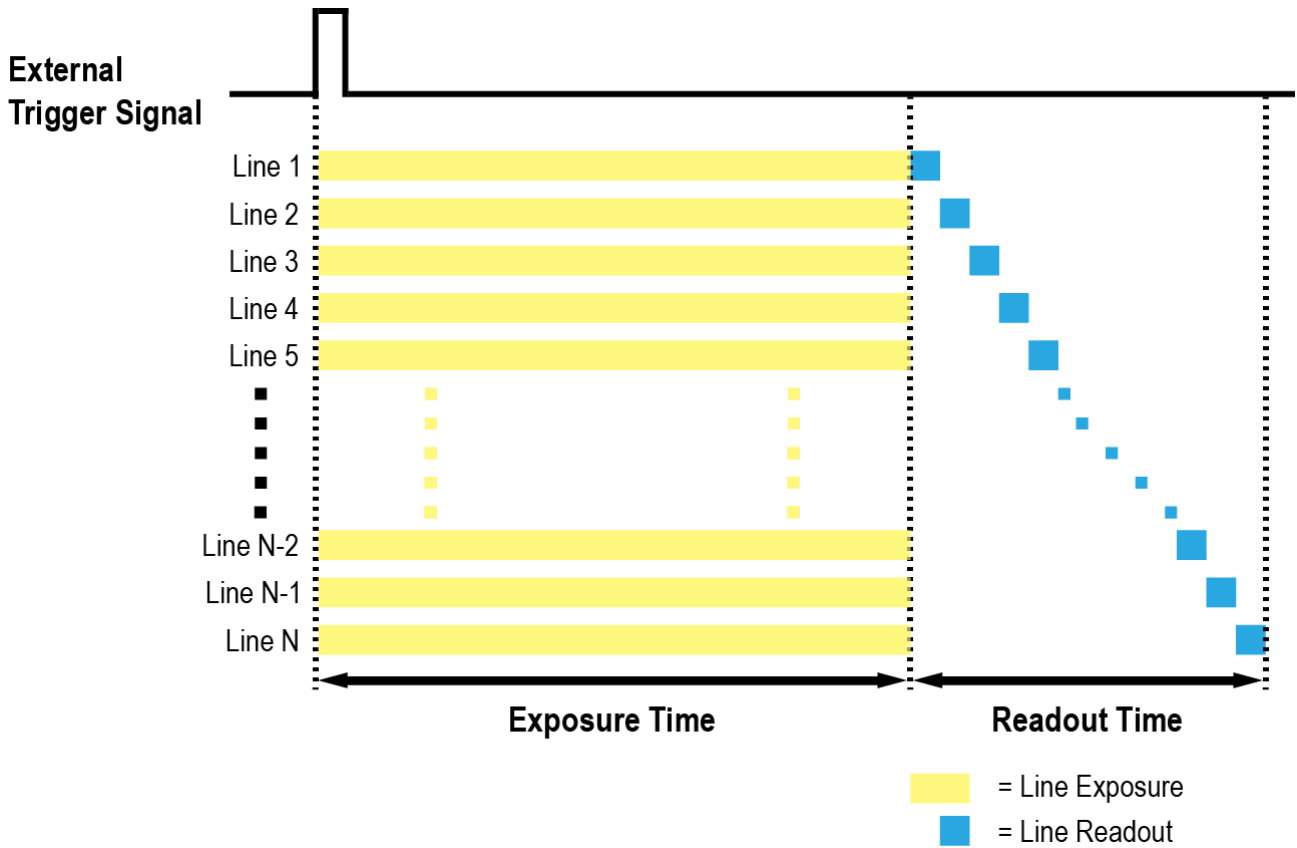

Figure 8.8 Global Shutter

## 8.7 Maximum Allowed Frame Rate

In general, the maximum allowed acquisition frame rate on the camera may be limited by several factors:

- The amount of time that it takes to transmit an acquired frame from the camera to your computer.  
The amount of time needed to transmit a frame depends on the bandwidth assigned to the camera.
- The amount of time it takes to read an acquired frame out of the image sensor and into the camera's frame buffer. This time varies depending on the setting for ROI. Frames with a smaller height and/or width take less time to read out of the sensor. The frame height and width are determined by the camera's **Height** and **Width** settings in the **Image Format Control** category.
- The CXP Link Configuration. When the camera is set for a CXP Link Configuration that uses more channels, it can typically transfer data out of the camera faster than when it is set for a CXP Link Configuration that uses less channels.
- The exposure time for acquired frames. If you use very long exposure time, you can acquire fewer frames per second.

### 8.7.1 Increasing the Maximum Allowed Frame Rate

You may find that you would like to acquire frames at a rate higher than the maximum allowed with the camera's current settings. In this case, you must adjust one or more of the factors that can influence the maximum allowed frame rate and then check to see if the maximum allowed frame rate has increased.

- The time that it takes to transmit a frame out of the camera is the main limiting factor on the frame rate. You can decrease the frame transmission time (and thus increase the maximum allowed frame rate) by using the ROI feature. Decreasing the size of the Image ROI may increase the maximum allowed frame rate. If possible, decrease the height and/or width of the Image ROI.
- If you are using a CXP Link Configuration with a low number of channels, consider using a CXP Link Configuration with a high number of channels. This will usually increase the maximum allowed frame rate.
- If you are using normal exposure times and you are using the camera at its maximum resolution, your exposure time will not normally restrict the frame rate. However, if you are using long exposure time, it is possible that your exposure time is limiting the maximum allowed frame rate. If you are using a long exposure time, try using a shorter exposure time and see if the maximum allowed frame rate increases (You may need to compensate for a lower exposure time by using a brighter light source or increasing the opening of your lens aperture.).



A very long exposure time severely limits the camera's maximum allowed frame rate. As an example, assume that your camera is set to use a 1 second exposure time. In this case, because each frame acquisition will take at least 1 second to be completed, the camera will only be able to acquire a maximum of one frame per second.

## 9 Camera Features

### 9.1 Image Region of Interest

The Image Region of Interest (ROI) feature allows you to specify a portion of the sensor array. You can acquire only the frame data from the specified portion of the sensor array while preserving the same quality as you acquire a frame from the entire sensor array.

With the ROI feature, you can increase the maximum allowed frame rate by decreasing the **Width** and/or **Height** parameters. The ROI is referenced to the top left corner [origin (0, 0)] of the sensor array as shown below.

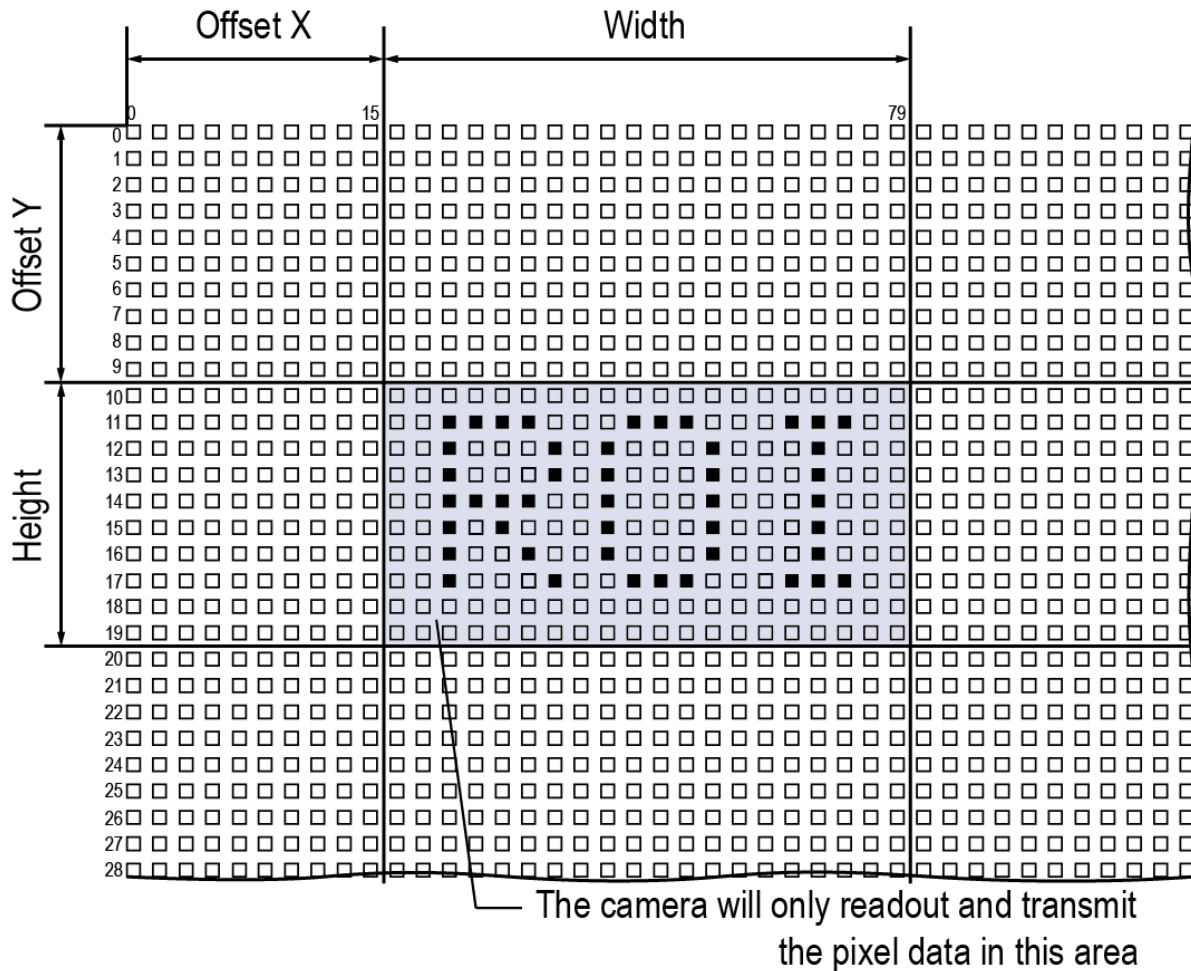

Figure 9.1 Region of Interest



The XML parameters related to ROI settings are as follows.

XML Parameters		Value	Description
ImageFormatControl	SensorWidth <sup>a</sup>	-	Effective width of the sensor
	SensorHeight <sup>a</sup>	-	Effective height of the sensor
	WidthMax	-	Maximum allowed width of the image with the current camera settings
	HeightMax	-	Maximum allowed height of the image with the current camera settings
	Width <sup>b</sup>	-	Sets the Width of the Image ROI.
	Height <sup>b</sup>	-	Sets the Height of the Image ROI.
	OffsetX <sup>c</sup>	-	Sets the horizontal offset from the origin to the Image ROI.
	OffsetY <sup>c</sup>	-	Sets the vertical offset from the origin to the Image ROI.

The unit for all parameters in this table is pixel.

a: Read only. User cannot change the value.

b: User configurable parameters for setting ROI

c: User configurable parameters for setting the origin of the ROI

**Table 9.1 XML Parameters related to ROI**

You can change the size of ROI by setting the **Width** and **Height** parameters in the **Image Format Control** category. You can also change the position of the ROI origin by setting the **Offset X** and **Offset Y** parameters. Make sure that the **Width + Offset X** value is less than the **Width Max** value, and the **Height + Offset Y** value is less than the **Height Max** value. You must set the size of the ROI first, and then set the Offset values since the **Width** and **Height** parameters are set to its maximum value by default.

- On the VC-25MX2-150 I camera, the **Width** parameter must be set to a multiple of 32, and the **Height** parameter must be set to a multiple of 2.

The minimum allowed setting values for the ROI Width and Height are shown below.

Camera Model	Minimum Width Settings	Minimum Height Settings
VC-25MX2-150 I	64	4

**Table 9.2 Minimum ROI Width and Height Settings**

On the VC-25MX2-150 I camera, the maximum allowed frame rates depending on Horizontal and Vertical ROI changes are shown below.

ROI Size (H × V)	1 Channel	2 Channels	4 Channels
5120 × 1000	230.4 fps	456.4 fps	750.9 fps
5120 × 2000	116.9 fps	231.7 fps	381.1 fps
5120 × 3000	78.3 fps	155.2 fps	255.4 fps
5120 × 4000	58.9 fps	116.7 fps	192.0 fps
64 × 5120	150.2 fps	150.2 fps	150.2 fps
2560 × 5120	93.1 fps	150.2 fps	150.2 fps
3008 × 5120	78.9 fps	150.2 fps	150.2 fps
4608 × 5120	51.2 fps	103.5 fps	150.2 fps
5120 × 5120	46.1 fps	93.1 fps	150.2 fps

**Table 9.3 Maximum Frame Rates by VC-25MX2-150 I ROI Changes**



Your CXP-12 Frame Grabber may place additional restrictions on how the ROI location and size must be set. Refer to your CXP-12 Frame Grabber user manual for more information.

## 9.2 Multi-ROI

The VC-25MX2-150 I camera provides the Multi-ROI feature which allows you to define up to 16 regions of the sensor array. When an image is acquired, only the pixel information from the defined regions will be readout of the sensor. The pixel data read out of the regions will then be combined together and will be transmitted from the camera as a single image.

The XML parameters related to Multi-ROI are as follows.

XML Parameters	Value	Description	
MultiROIControl	MultiROISelector	-	Selects the ROI to set.
	MultiROIMode	On/Off	Enables / Disables the selected ROI.
	MultiROIWidth	-	Width setting for the selected ROI
	MultiROIHeight	-	Height setting for the selected ROI
	MultiROIOffsetX	-	Horizontal offset from the origin to the selected ROI
	MultiROIOffsetY	-	Vertical offset from the origin to the selected ROI
	MultiROIValid <sup>a</sup>	-	Verifies the validation of the Multi-ROI setting values.
	MultiROIStatus	Active/Inactive	Displays the status of the Multi ROI feature. <ul style="list-style-type: none"> <li>Active: The Multi-ROI feature is in use.</li> <li>Inactive: The Multi-ROI feature is not in use.</li> </ul>

The unit for all parameters in this table is pixel.

a: If the setting values for the Multi-ROI feature are valid, 'True' will be returned or the check box will be selected.

**Table 9.4 XML parameters related to Multi-ROI**

It is recommended that you first set the **Multi-ROI Width** parameter, since all of the regions must be the same width. The next step in the setup process is to define each individual region as desired. Up to 16 regions can be set up ranging from 0 through 15. Use the **Multi-ROI Selector** parameter to select which ROI to set and then set the ROI to On/Off by using the **Multi-ROI Mode** parameter. Then, set the **Multi-ROI Offset X**, **Multi-ROI Offset Y** and **Multi-ROI Height** parameters to define each region.

In the figure below, for example, three regions have been set. With these settings, the camera would output an image as follows:

- MultiROI Width × the total height of the three regions (Region0 Height + Region1 Height + Region2 Height)

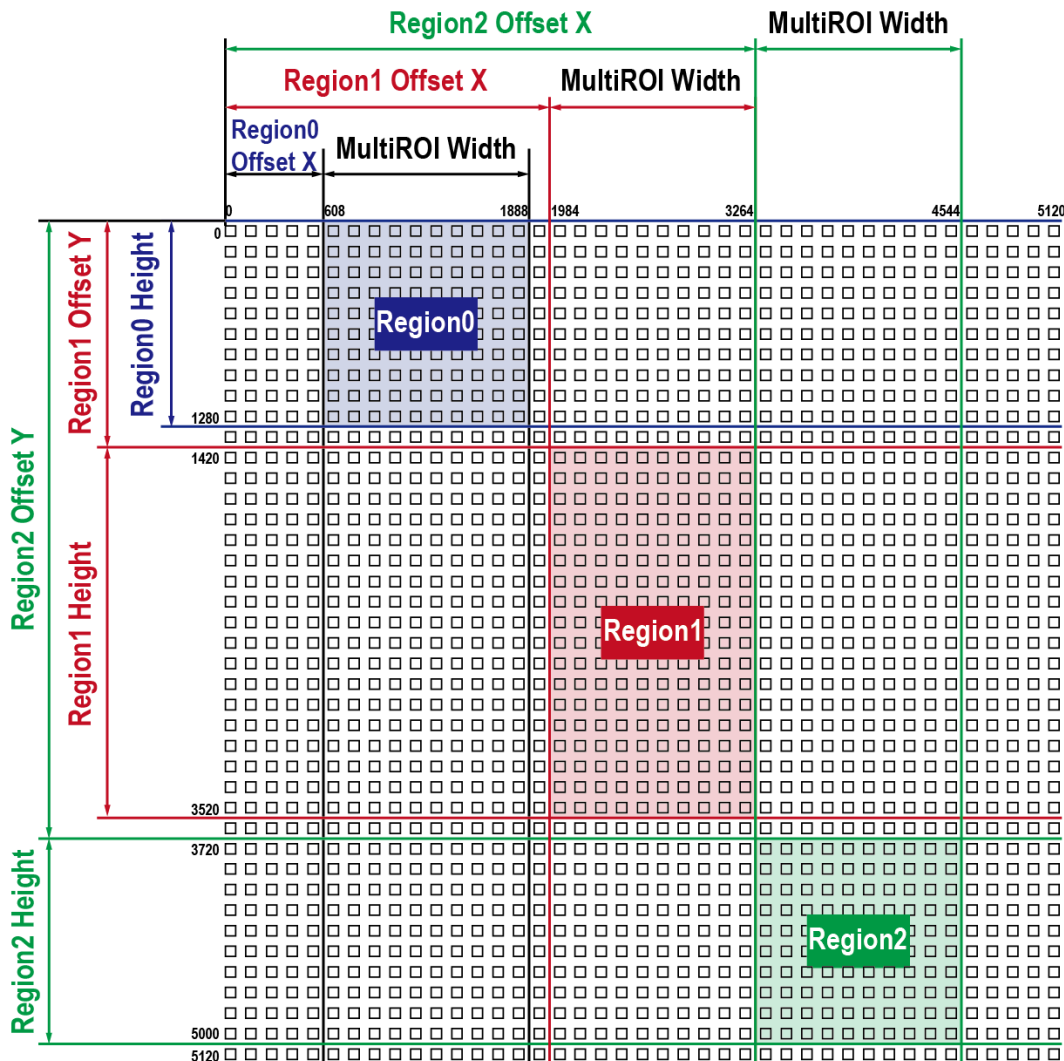

Figure 9.2 Multi-ROI

There are several things to keep in mind when setting the Multi-ROI feature on the VC-25MX2-150 I camera:

- The sum of the Multi-ROI Offset X value plus the Multi-ROI Width value must not exceed the width of the camera's sensor.
- The sum of the Multi-ROI Offset Y value plus the Multi-ROI Height value must not exceed the height of the camera's sensor.
- The Multi-ROI Offset X and Multi-ROI Width value must be a multiple of 32.
- The Multi-ROI Offset Y and Multi-ROI Height value must be a multiple of 2.
- You can save the Multi-ROI setting values as a User Set and then load the values to the camera when desired. For more information, refer to [9.24 User Set Control](#).

## 9.3 Binning

The Binning has the effects of increasing the level value and decreasing resolution by summing the values of the adjacent pixels and sending them as one pixel. The XML parameters related to Binning are as follows.

XML Parameters		Value	Description
ImageFormatControl	BinningSelector	Sensor	N/A
		Logic	Applies the Binning digitally by the logic.
	BinningHorizontalMode	Sum	Adds pixel values from the adjacent pixels as specified in the Binning Horizontal parameter, and then sends them as one pixel.
		Average	Adds pixel values from the adjacent pixels as specified in the Binning Horizontal parameter and divides them by the number of combined pixels, and then sends them as one pixel.
	BinningHorizontal	1×, 2×, 4×	Number of horizontal pixels to combine together.
	BinningVerticalMode	Sum	Adds pixel values from the adjacent pixels as specified in the Binning Vertical parameter, and then sends them as one pixel.
		Average	Adds pixel values from the adjacent pixels as specified in the Binning Vertical parameter and divides them by the number of combined pixels, and then sends them as one pixel.
	BinningVertical	1×, 2×, 4×	Number of vertical pixels to combine together.

**Table 9.5 XML Parameters related to Binning**

For example, if you set 2 × 2 binning, the camera's resolution is reduced to 1/4. If you set the **Binning Mode** to **Sum**, the maximum allowed resolution of the image is reduced 1/2 and the responsivity of the camera is quadrupled. If you set the **Binning Mode** to **Average**, the maximum allowed resolution of the image is reduced to 1/2, but there is no difference in responsivity between a binned image and an original image. The **Width Max** and **Height Max** parameter, indicating the maximum allowed resolution of the image with the current camera settings, will be updated depending on the binning settings. And also, the **Width**, **Height**, **Offset X** and **Offset Y** parameters will be updated depending on the binning settings. You can verify the current resolution through the **Width** and **Height** parameters.

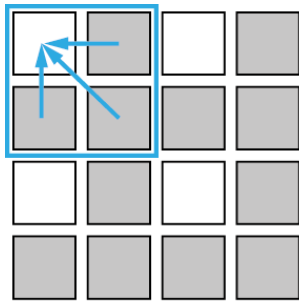

**2 × 2 Binning**

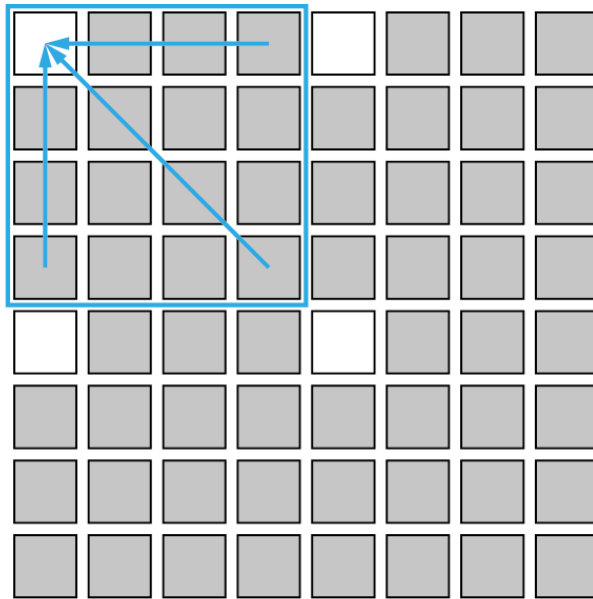

**4 × 4 Binning**

**Figure 9.3 2 × 2 Binning and 4 × 4 Binning**

## 9.4 CXP Link Configuration

The VC-25MX2-150 I camera must be connected to a CXP-12 Frame Grabber installed in your computer via CoaXPress 2.0 interface. CoaXPress 2.0 interface allows you to connect a camera to a CXP-12 Frame Grabber by using simple coax cabling and allows up to 12.5 Gbps data rate per cable. The VC-25MX2-150 I camera supports one master connection and up to three extension connections to configure a link. In compliance with the CoaXPress standard, the camera includes an automatic link detection mechanism (Plug and Play) to correctly detect the camera to CXP-12 Frame Grabber connections.

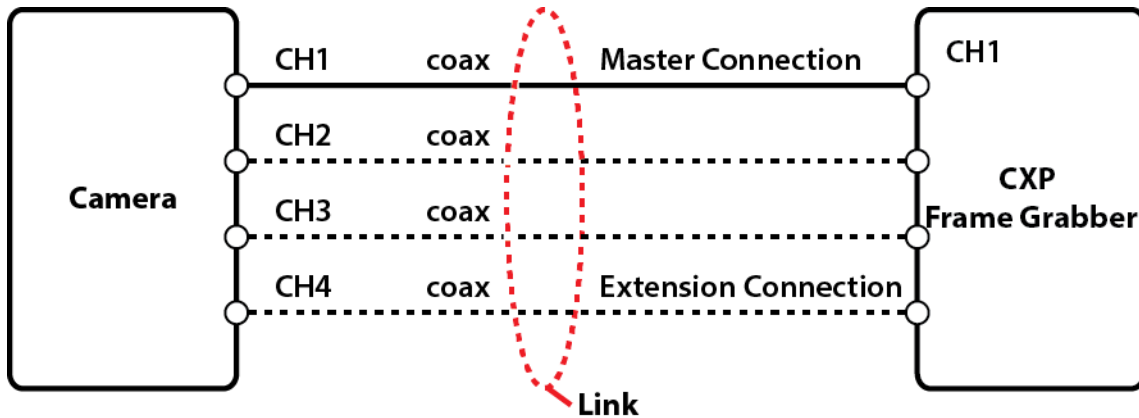

Figure 9.4 CXP Link Configuration

The XML parameters related to the link configuration between the camera and CXP-12 Frame Grabber are as follows.

XML Parameters		Value	Description
CoaXPress	CxpLinkConfigurationPreferred	Read Only	<ul style="list-style-type: none"> <li>Displays bit rate and the number of connections to be set for the link configuration between the camera and Host (Frame Grabber) while discovering devices.</li> <li>Saves the current CxpLinkConfiguration values as the CxpLinkConfigurationPreferred value when you execute the User Set Save parameter.</li> </ul>
	CxpLinkConfiguration	CXP12_X1 CXP12_X2 CXP12_X4	Sets bit rate and the number of connections for the link configuration. ex) CXP12_X4: Four connections running at a maximum of CXP12 speed (12.5 Gbps)

Table 9.6 XML Parameters related to CXP Link Configuration



## 9.5 Pixel Format

The VC-25MX2-150 I camera processes image data in the unit of 10 bit. You can determine the pixel format (8 bits or 10 bits) of these image data transmitted from the camera by using the **Pixel Format** parameter. When the camera is set for 8-bit pixel format, the 2 least significant bits will be dropped from overall 10 bits.

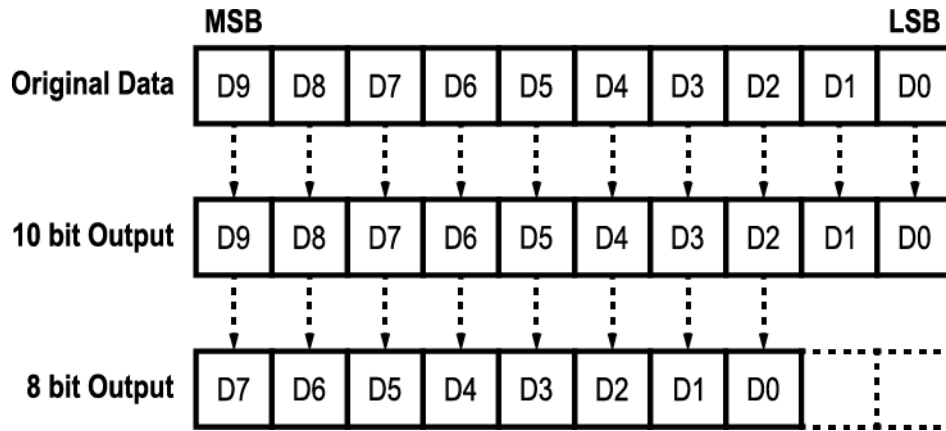

Figure 9.5 VC-25MX2-150 I Pixel Format

The XML parameter related to Pixel Format is as follows.

XML Parameter		Description
ImageFormatControl	PixelFormat	Sets the pixel format supported by the device.

Table 9.7 XML Parameter related to Pixel Format

The available pixel formats on the monochrome and color cameras are as follows.

Mono Sensor	Color Sensor
<ul style="list-style-type: none"> <li>• Mono 8</li> <li>• Mono 10</li> </ul>	<ul style="list-style-type: none"> <li>• Mono 8</li> <li>• Mono 10</li> <li>• Bayer GB 8</li> <li>• Bayer GB 10</li> </ul>

Table 9.8 Pixel Format Values

## 9.6 Data ROI (Color Camera)

The Balance White Auto feature provided by the color camera uses the pixel data from a Data Region of Interest (ROI) to adjust the related parameters. The XML parameters related to Data ROI are as follows.

XML Parameters		Value	Description
DataRoiControl	RoiSelector	WhiteBalanceAuto	<ul style="list-style-type: none"> <li>Selects a Data ROI used for Balance White Auto.</li> <li>Only available on the color camera.</li> </ul>
	RoiOffsetX	-	X coordinate of start point ROI
	RoiOffsetY	-	Y coordinate of start point ROI
	RoiWidth	-	Width of ROI
	RoiHeight	-	Height of ROI

**Table 9.9 XML Parameters related to Data ROI**

Only the pixel data from the area of overlap between the Data ROI and the Image ROI by your settings will be effective if you use the Image ROI and Data ROI at the same time. The effective ROI is determined as shown in the figure below.

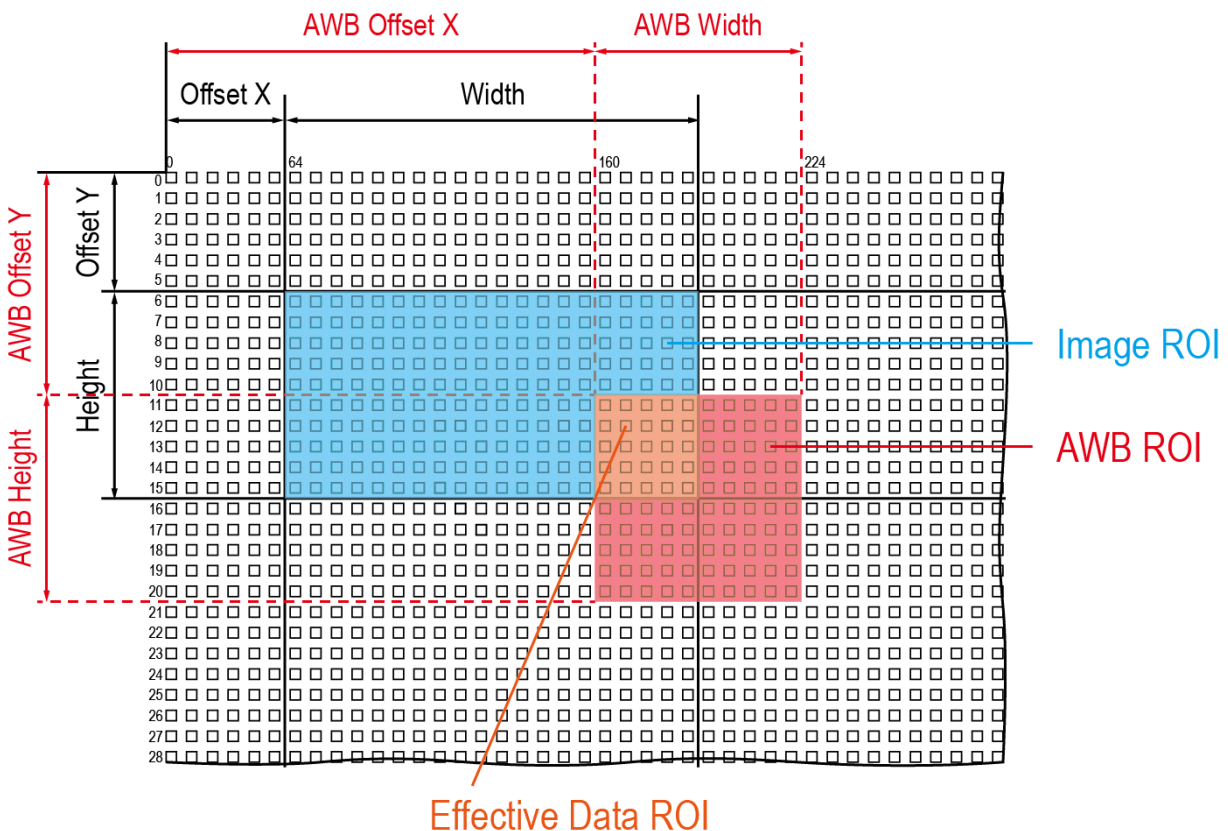

**Figure 9.6 Effective Data ROI**

## 9.7 White Balance (Color Camera)

The color camera includes the white balance capability to adjust the color balance of the images transmitted from the camera. With the white balancing scheme used on the VC-25MX2-150 I camera, the Red, Green and Blue intensities can be adjusted individually. You can set the intensity of each color by using the **Balance Ratio** parameter. The Balance Ratio value can range from 1.0 to 4.0. If the Balance Ratio parameter is set to 1.0 for a color, the intensity of the color will be unaffected by the white balance mechanism. If the Balance Ratio parameter is set to greater than 1.0, the intensity of the color will be proportionally increased to the ratio. For example, if the Balance Ratio is set to 1.5, the intensity of that color will be increased by 50%.

The XML parameters related to White Balance are as follows.

XML Parameters		Value	Description
AnalogControl	BalanceRatioSelector	Red	A Balance Ratio value will be applied to red pixels.
		Green	A Balance Ratio value will be applied to green pixels.
		Blue	A Balance Ratio value will be applied to blue pixels.
	BalanceRatio	1.0× ~ 4.0×	Adjusts the ratio of the selected color.

Table 9.10 XML Parameters related to White Balance

### 9.7.1 Balance White Auto

The Balance White Auto feature is implemented on the color camera. It will control the white balance of the image acquired from the color camera according to the GreyWorld algorithm. Before using the Balance White Auto feature, you need to set the Data ROI for Balance White Auto. If you do not set the related Data ROI, the pixel data from the Image ROI will be used to control the white balance. As soon as the **Balance White Auto** parameter is set to **Once**, the Balance Ratio values for Red and Blue will be automatically adjusted to adjust the white balance by referring to Green. The XML parameters related to Balance White Auto are as follows.

XML Parameter		Value	Description
AnalogControl	BalanceWhiteAuto	Off	Balance White Auto Off
		Once	White Balance is adjusted once and then Off.

Table 9.11 XML Parameter related to Balance White Auto

## 9.8 Gain and Black Level

Increasing the **Gain** parameter increases all pixel values of the image. This results in a higher grey value output from the camera for a given amount of output from the image sensor.

1. Selects the Gain Control (Digital All is only available) to be adjusted by using the **Gain Selector** parameter.
2. Sets the Gain parameter to the desired value.

Adjusting the **Black Level** parameter will result in an offset to the pixel values output from the camera.

1. Selects the Black Level Control (Digital All is only available) to be adjusted by using the **Black Level Selector** parameter.
2. Sets the Black Level parameter to the desired value. The available setting range varies depending on the Pixel Format settings.

The XML parameters related to Gain and Black Level are as follows.

XML Parameters		Value	Description
AnalogControl	GainSelector	DigitalAll	Applies the Gain value to all digital channels.
	Gain	1.0× ~ 32.0×	Sets a digital gain value.
	BlackLevelSelector	DigitalAll	Applies the Black Level value to all digital channels.
	BlackLevel	0 ~ 63	Sets a black level value (The setting range is based on the 10-bit Pixel Format.).

**Table 9.12 XML Parameters related to Gain and Black Level**

## 9.9 Defective Pixel Correction

The CMOS sensor may have defect pixels which cannot properly react to the light. Correction is required since it may deteriorate the quality of output image. Defect pixel information of CMOS used for each camera is entered into the camera during the manufacturing process. If you want to add defect pixel information, it is required to enter coordinate of new defect pixel into the camera. For more information, refer to [Appendix A](#).

### 9.9.1 Correction Method

A correction value for a defect pixel is calculated based on the valid pixel value adjacent in the same line.

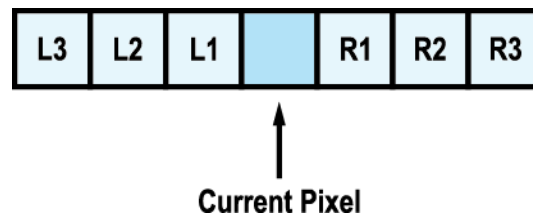

**Figure 9.7 Location of Defect Pixel to be corrected**

If the Current Pixel is a defect pixel as shown in the figure above, the correction value for this pixel is obtained as shown in the following table depending on whether surrounding pixels are defect pixels or not.

Adjacent Defect Pixel	Correction Value of Current Pixel
None	$(L1 + R1) / 2$
L1	R1
R1	L1
L1, R1	$(L2 + R2) / 2$
L1, R1, R2	L2
L2, L1, R1	R2
L2, L1, R1, R2	$(L3 + R3) / 2$
L2, L1, R1, R2, R3	L3
L3, L2, L1, R1, R2	R3

**Table 9.13 Calculation of Defect Pixel Correction Value**

## 9.10 Dark Signal Non-uniformity Correction

In theory, when a digital camera acquires an image in complete darkness, all of the pixel values in the image should be near zero and they should be equal. In practice, however, slight variations in the performance of the pixels in the sensor will cause some variations in the pixel values output from the camera when the camera is acquiring in darkness. This variation is known as Dark Signal Non-Uniformity (DSNU). The VC-25MX2-150 I camera provides the DSNU Correction feature.

The XML parameters related to DSNU are as follows.

XML Parameters	Value	Description	
DSNU	DSNUDataSelector	Default	Selects Default as a non-volatile memory location to load DSNU data from.
		Space1 - 3	Selects a user defined location as a non-volatile memory location to save DSNU data to or load DSNU data from.
	DSNUDataGenerate	-	Generates the DSNU data for the current camera settings.
	DSNUDataSave	-	Saves the generated DSNU data in the non-volatile memory. <ul style="list-style-type: none"> <li>The generated data by executing the <b>DSNUDataGenerate</b> command are saved in the volatile memory so that the data are lost if the camera is reset or if power is turned off. To use the data after the camera is powered on or reset, save them in the non-volatile memory.</li> </ul>
	DSNUDataLoad	-	Loads the DSNU data from the non-volatile memory into the volatile memory.

**Table 9.14 XML Parameters related to DSNU**

## 9.10.1 Generating and Saving User DSNU Correction Values

To generate and save user-defined DSNU correction values, use the following procedure.



- For optimum DSNU correction values, we recommend that you generate DSNU data after the temperature of the camera housing has been stabilized.
- Before generating DSNU data, set the FFC feature to Off.

1. To obtain the optimum DSNU correction values, set the ROI to the actual settings you will be using during normal operation.
2. Ensure that the camera will be acquiring images in complete darkness by covering the camera lens, closing the iris in the lens, or darkening the room.
3. Begin acquiring images by setting the camera for the Free-Run mode.
4. Execute the **DSNU Data Generate** command to generate DSNU data for the current camera settings.
5. The generated DSNU correction values will be activated and saved in the camera's volatile memory.
6. To save the generated DSNU correction values in the camera's Flash (non-volatile) memory, use the **DSNU Data Selector** parameter to specify a location to save the DSNU correction values, and then execute the **DSNU Data Save** command. The previous DSNU values saved in the memory will be overwritten.  
To disregard the generated DSNU correction values and load the existing values in the Flash memory, use the **DSNU Data Selector** parameter to select a desired DSNU correction values, and then execute the **DSNU Data Load** command.

## 9.11 Photo Response Non-uniformity Correction

In theory, when a digital camera acquires images with the camera viewing a uniform light-colored target in bright light, all of the pixel values in the image should be near the maximum grey value and they should be equal.

In practice, however, slight variations in the performance of the pixels in the sensor, variations in the optics, and variations in the lighting will cause some variations in the pixel values output from the camera. This variation is known as Photo Response Non-Uniformity (PRNU). The VC-25MX2-150 I camera provides the PRNU correction feature.

The XML parameters related to PRNU are as follows.

XML Parameters	Value	Description	
PRNU	PRNUNUDataSelector	Default	Selects Default as a non-volatile memory location to load PRNU data from.
		Space1 - 3	Selects a user defined location as a non-volatile memory location to save PRNU data to or load PRNU data from.
	PRNUDataGenerate	-	Generates the PRNU data for the current camera settings.
	PRNUDataSave	-	Saves the generated PRNU data in the non-volatile memory. <ul style="list-style-type: none"> <li>The generated data by executing the <b>PRNUDataGenerate</b> command are saved in the volatile memory so that the data are lost if the camera is reset or if power is turned off. To use the data after the camera is powered on or reset, save them in the non-volatile memory.</li> </ul>
	PRNUDataLoad	-	Loads the PRNU data from the non-volatile memory into the volatile memory.

**Table 9.15 XML Parameters related to PRNU**



## 9.11.1 Generating and Saving User PRNU Correction Values

To generate and save user-defined PRNU correction values, use the following procedure.



- To generate the optimum PRNU data,
  - we recommend that you generate DSNU correction values first before generating PRNU correction values.
  - set the FFC feature to Off before generating PRNU correction values.
  - the grey reference image must be acquired at uniform illumination. We strongly recommend that you use a high quality light source to deliver uniform illumination. Standard illumination may not be appropriate.
- The PRNU correction values stored in Default are optimized for use in typical situations and will provide good camera performance in most cases. Use of the values stored in Default is recommended.

1. To generate PRNU correction values suitable for your operating conditions, set the ROI to the actual settings you will be using during normal operation. We strongly recommend that you use the Default PRNU correction values stored in Default, if you cannot set up the uniform illumination.
2. Without mounting a lens on the camera, place a uniform illumination (e.g. backlight) in the field of view of the camera. Set up the camera as you would for normal operation. We recommend that you make adjustments to achieve the digital output level in a range from 150 to 200 (Gain: 1.00 at 8 bit).
3. Begin acquiring images by setting the camera for the Free-Run mode.
4. Execute the **PRNU Data Generate** command to generate PRNU correction values for the current camera settings.
5. The generated PRNU correction values will be activated and saved in the camera's volatile memory.
6. To save the generated PRNU correction values in the camera's Flash (non-volatile) memory, use the **PRNU Data Selector** parameter to specify a location to save the PRNU correction values, and then execute the **PRNU Data Save** command. The previous PRNU values saved in the memory will be overwritten.  
To disregard the generated PRNU correction values and load the existing values in the Flash memory, use the **PRNU Data Selector** parameter to select a desired PRNU correction values, and then execute the **PRNU Data Load** command.

## 9.12 Flat Field Correction

The Flat Field Correction feature improves the image uniformity when you acquire a non-uniformity image due to external conditions. The Flat Field Correction feature of the VC-25MX2-150 I camera can be summarized by the following equation.

$$IC = IR / IF$$

IC: Level value of corrected image

IR: Level value of original image

IF: Level value of Flat Field data

In actual use conditions, generate a Flat Field correction data and then save the data into the non-volatile memory of the camera by following the procedure below.

1. Execute the **Flat Field Data Generate** parameter.  
After executing the **Flat Field Data Generate** parameter, you must acquire one image to generate the scaled down Flat Field correction data.
2. Use the **Flat Field Data Selector** parameter to specify a location to save the generated Flat Field correction data.
3. Execute the **Flat Field Data Save** parameter to save the generated Flat Field data into the non-volatile memory. When the scaled down Flat Field data are used for correction, they are expanded and applied with a Bilinear Interpolation as shown in the Figure 9.9.

To disregard the generated Flat Field correction data and load the existing Flat Field correction data, execute the **Flat Field Data Load** parameter before executing the **Flat Field Data Save** parameter.

4. Set the **Flat Field Correction** parameter to **On** to apply the Flat Field data to the camera.



- It is recommended that you enable the **Defective Pixel Correction** feature before executing the **Flat Field Data Generate** parameter.
- Before executing the **Flat Field Data Generate** parameter, you must set the camera as follows:
  - OffsetX, Y: 0
  - Width, Height: Maximum values
- After executing the **Acquisition Start** command, you need to operate the camera with the free-run mode or apply a trigger signal to acquire an image.

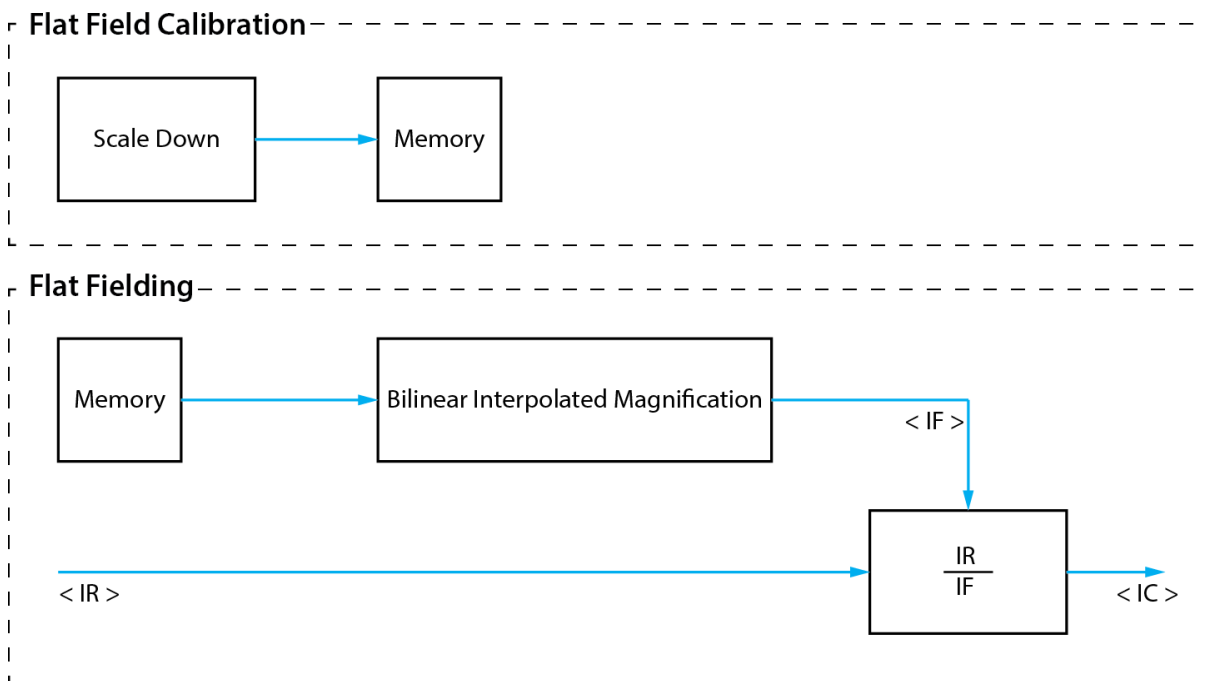

Figure 9.8 Generation and Application of Flat Field Data

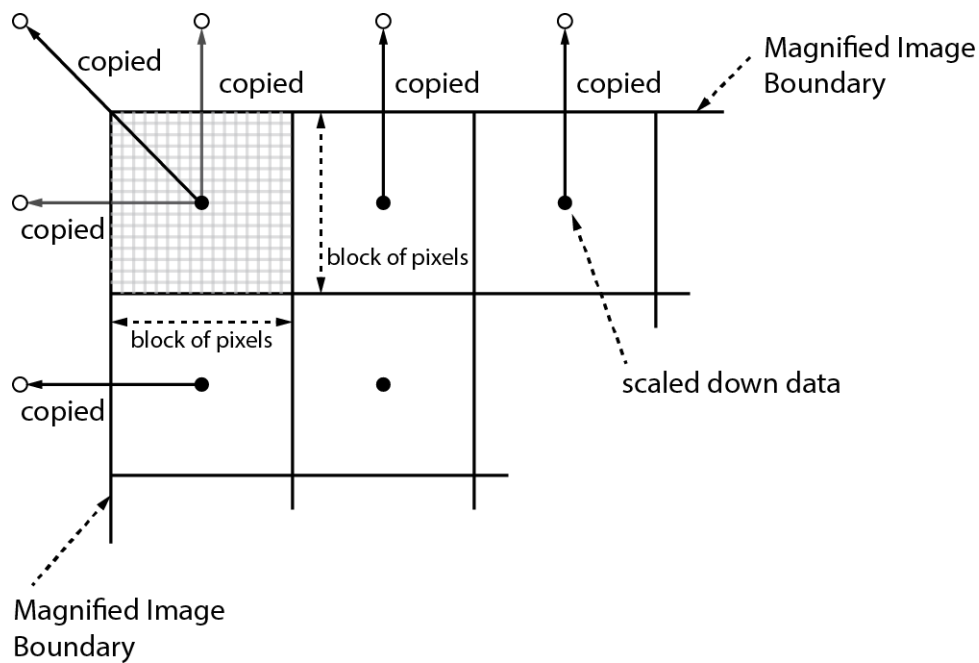

Figure 9.9 Bilinear Interpolated Magnification

The XML parameters related to Flat Field Correction are as follows.

XML Parameters		Value	Description
FlatFieldControl	FlatFieldCorrection	Off	Disables the Flat Field Correction feature.
		On	Enables the Flat Field Correction feature.
	FlatFieldDataSelector	Space0 ~ Space15	Selects a location to save Flat Field data to or load Flat Field data from. <ul style="list-style-type: none"> <li>Space0~Space15: User defined location</li> </ul>
	FlatFieldDataGenerate	-	Generates the Flat Field data.
	FlatFieldDataSave	-	Saves the generated Flat Field correction data in the non-volatile memory. <ul style="list-style-type: none"> <li>The data generated by executing the <b>Flat Field Data Generate</b> parameter are saved in the volatile memory so that the data are lost if the camera is reset or if power is turned off. To use the data after the camera is powered on or reset, save them in the non-volatile memory.</li> </ul>
	FlatFieldDataLoad	-	Loads the Flat Field data from the non-volatile memory into volatile memory.

**Table 9.16 XML Parameters related to Flat Field Correction**

## 9.12.1 Flat Field Data Selector

As mentioned above, the generated Flat Field correction data are stored in the camera's volatile memory and the data are lost if the camera is reset or powered off. To use the generated Flat Field correction data after the camera is powered on or reset, you need to save them in the camera's non-volatile memory.

The VC-25MX2-150 I camera provides sixteen reserved locations in the camera's non-volatile memory available for saving and loading the Flat Field correction data. You can use the **Flat Field Data Selector** parameter to select a location as desired.

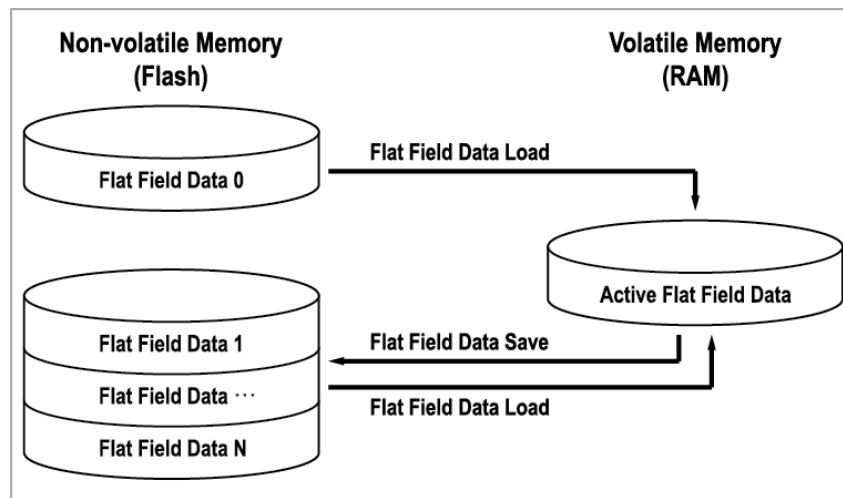

Figure 9.10 Flat Field Data Selector

### Saving Flat Field Data

In order to save the active Flat Field data into a reserved location in the camera's Flash memory, follow the procedure below.

1. Use the **Flat Field Data Selector** parameter to specify a location to save the active Flat Field data.
2. Execute the **Flat Field Data Save** parameter to save the active Flat Field data to the selected location.

### Loading Flat Field Data

If you saved Flat Field correction data into the camera's non-volatile memory, you could load the saved Flat Field correction data from the camera's non-volatile memory into the camera's active Flat Field data location.

1. Use the **Flat Field Data Selector** parameter to specify a reserved location whose Flat Field correction data will be loaded into the camera's active Flat Field data location.
2. Execute the **Flat Field Data Load** parameter to load the selected Flat Field correction data into the active Flat Field data location.

## 9.13 Digital I/O Control

The Control I/O receptacle of the camera can be operated in various modes.

The XML parameters related to Digital I/O Control are as follows.

XML Parameters		Value	Description
DigitalIOControl	LineSelector	Line1	Selects the number 4 pin of the camera's Control I/O receptacle as an output line.
	LineInverter	FALSE	Disables inversion on the output signal of the line.
		TRUE	Enables inversion on the output signal of the line.
	LineSource	Off	Disables the line output.
		ExposureActive	Outputs pulse signals indicating the current exposure time.
		FrameActive	Outputs pulse signals indicating a frame readout time.
		UserOutput0	Outputs pulse signals set by User Output Value.
		Timer0Active	Outputs user-defined Timer signals as pulse signals.
	UserOutputValue	FALSE	Sets the bit state of the line to Low.
		TRUE	Sets the bit state of the line to High.
DebounceTime	0 ~ 1,000,000	Sets a Debounce Time in microseconds (Default: 0.5 $\mu$ s).	

Table 9.17 XML Parameters related to Digital I/O Control

When you set the **Line Source** to **User Output0**, you can use the user setting values as output signals.

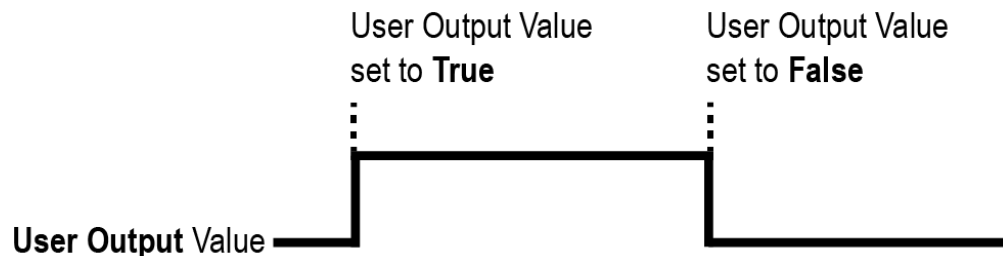

Figure 9.11 User Output

The camera can provide an Exposure Active output signal. The signal goes high when the exposure time for each frame acquisition begins and goes low when the exposure time ends as shown in the figure below. This signal can be used as a flash trigger and is also useful when you are operating a system where either the camera or the object being imaged is movable. Typically, you do not want the camera to move during exposure. You can monitor the Exposure Active signal to know when exposure is taking place and thus know when to avoid moving the camera.

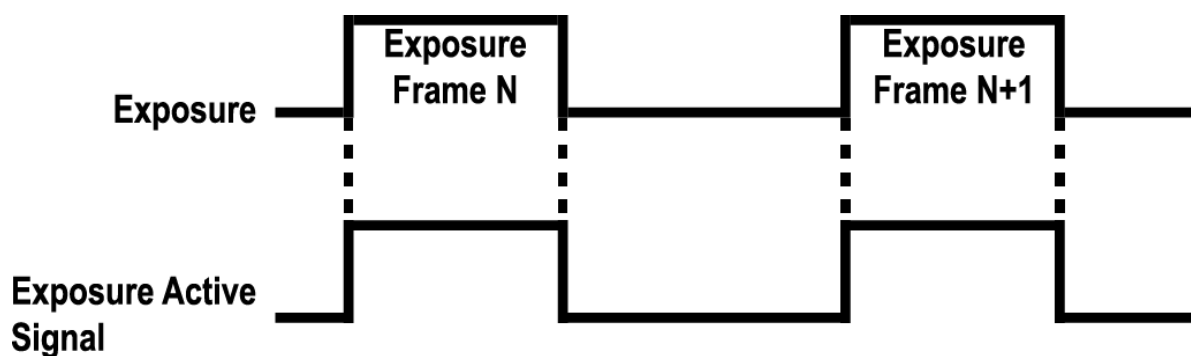

Figure 9.12 Exposure Active Signal

### 9.13.1 Debounce

The Debounce feature of the VC-25MX2-150 I camera allows to supply only valid signals to the camera by discriminating between valid and invalid input signals. The **Debounce Time** parameter specifies the minimum time that an input signal must remain High or Low in order to be considered as a valid input signal. When you use the Debounce feature, be aware that there is a delay between the point where the valid input signal arrives and the point where the signal becomes effective. The duration of the delay is determined by the Debounce Time parameter setting value. When you set the **Debounce Time** parameter, High and Low signals shorter than the setting value are considered invalid and ignored as shown in the figure below.

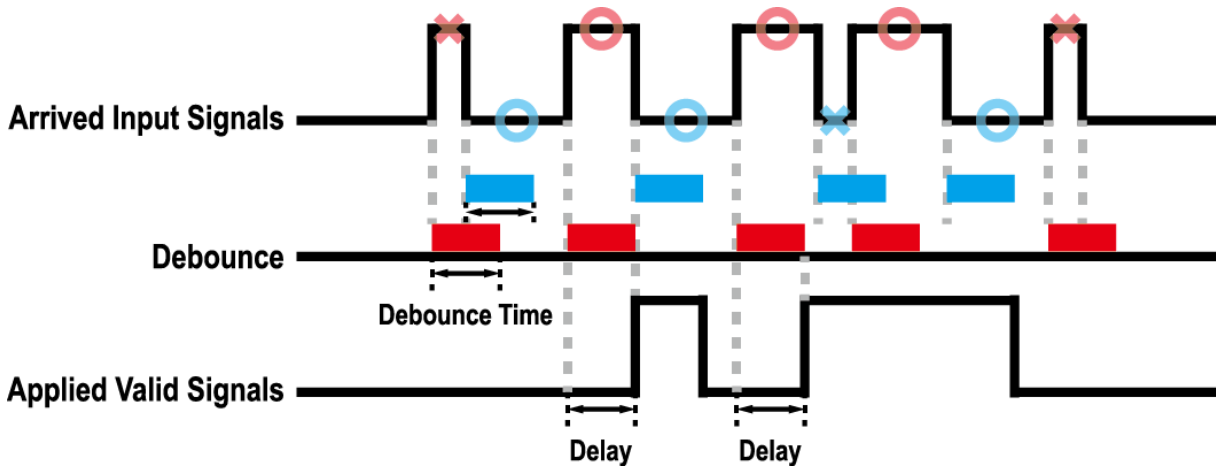

Figure 9.13 Debounce

The XML parameter related to Debounce Time is as follows.

XML Parameters		Value	Description
DigitalIOControl	Debounce Time	0 – 1,000,000 $\mu$ s	Sets a Debounce Time in microseconds (Default: 0.5 $\mu$ s).

Table 9.18 XML Parameter related to Debounce Time



## 9.14 Timer Control

When the **Line Source** parameter is set to **Timer0Active**, the camera can provide output signals by using the Timer. On the VC-25MX2-150 I camera, the Frame Active, Exposure Active event or external trigger signal is available as Timer source signal.

The XML parameter related to Timer are as follows.

XML Parameters		Value	Description	
CounterAnd TimerControl	TimerDuration	1 ~ 60,000,000 $\mu$ s	Sets the duration of the Timer output signal to be used when Timer Trigger Activation is set to Rising/Falling Edge.	
	TimerDelay	0 ~ 60,000,000 $\mu$ s	Sets the delay time to be applied before starting the Timer.	
	TimerReset	-	Resets the Timer and starts it again.	
	TimerTriggerSource	Off	Off	Disables the Timer trigger.
		ExposureActive	ExposureActive	Sets the Timer to use the current exposure time as the source signal.
		FrameActive	FrameActive	Sets the Timer to use a frame readout time as the source signal.
	Line0	Line0	Sets the Timer to use the external trigger signal as the source signal.	
	TimerTriggerActivation	RisingEdge	RisingEdge	Specifies that a rising edge of the selected trigger signal will act as the Timer trigger.
		FallingEdge	FallingEdge	Specifies that a falling edge of the selected trigger signal will act as the Timer trigger.
		LevelHigh	LevelHigh	Specifies that the Timer output signal will be valid as long as the selected trigger signal is High.
		LevelLow	LevelLow	Specifies that the Timer output signal will be valid as long as the selected trigger signal is Low.

**Table 9.19 XML Parameters related to Timer Control**

For example, when the Timer Trigger Source is set to Exposure Active and the Timer Trigger Activation is set to Level High, the Timer will act as follows:

1. When the source signals set by the Timer Trigger Source parameter are applied, the Timer will start operations.
2. The delay set by the Timer Delay parameter begins to expire.
3. When the delay expires, the Timer signal goes high as long as the source signal is high.

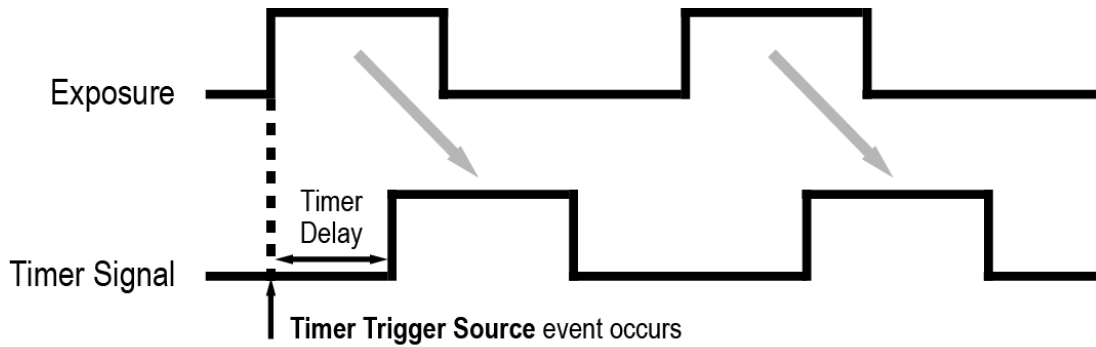

\* Timer Trigger Activation is set to Level High.

Figure 9.14 Timer Signal

## 9.15 Cooling Control

A fan is installed on the rear panel of the camera to radiate heat. You can set the fan to turn on or off. You can also set the fan to turn on when a specified internal temperature is reached.

The XML parameters related to Cooling Control are as follows.

XML Parameters		Value	Description
CoolingControl	TargetTemperature	-10°C ~ 80°C	Sets the temperature to operate the fan when the FanOperationMode parameter is set to Temperature.
	FanOperationMode	Off	Turns off the fan.
		On	Turns on the fan.
		Temperature	Turns on the fan when the internal temperature exceeds the value set in the Target Temperature parameter.
FanSpeed	-	Displays the current Fan RPM.	

**Table 9.20 XML Parameters related to Cooling Control**

## 9.16 Temperature Monitor

The camera has an embedded sensor chip to monitor the internal temperature.

The XML parameters related to Device Temperature are as follows.

XML Parameters		Value	Description
DeviceControl	DeviceTemperatureSelector	Mainboard	Sets a temperature measuring spot to the mainboard.
	DeviceTemperature	-	Displays device temperature in Celsius.

**Table 9.21 XML Parameters related to Device Temperature**

## 9.17 Status LED

A LED is installed on the rear panel of the camera to inform the operation status of the camera. LED status and corresponding camera status are as follows:

Status LED	Description
Steady Red	The camera is not initialized.
Slow Flashing Red	A CXP Link is not configured.
Fast Flashing Orange	The camera is checking a CXP Link configuration.
Steady Green	A CXP Link is configured.
Fast Flashing Green	The camera is transmitting image data.

**Table 9.22 Status LED**

## 9.18 Test Pattern

To check whether the camera operates normally or not, it can be set to output test patterns generated in the camera, instead of image data from the image sensor. Four types of test patterns are available; images with different values in horizontal direction (Grey Horizontal Ramp), images with different values in diagonal direction (Grey Diagonal Ramp), moving images with different values in diagonal direction (Grey Diagonal Ramp Moving) and images with different values in diagonal direction (Sensor Specific).

The XML parameter related to Test Pattern is as follows.

XML Parameters		Value	Description
ImageFormatControl	TestPattern	Off	Disables the Test Pattern feature.
		GreyHorizontalRamp	Sets to Grey Horizontal Ramp.
		GreyDiagonalRamp	Sets to Grey Diagonal Ramp.
		GreyDiagonalRampMoving	Sets to Grey Diagonal Ramp Moving.
		SensorSpecific	Sets to the Test Pattern generated by the image sensor.

**Table 9.23 XML Parameters related to Test Pattern**



**Figure 9.15 Grey Horizontal Ramp**

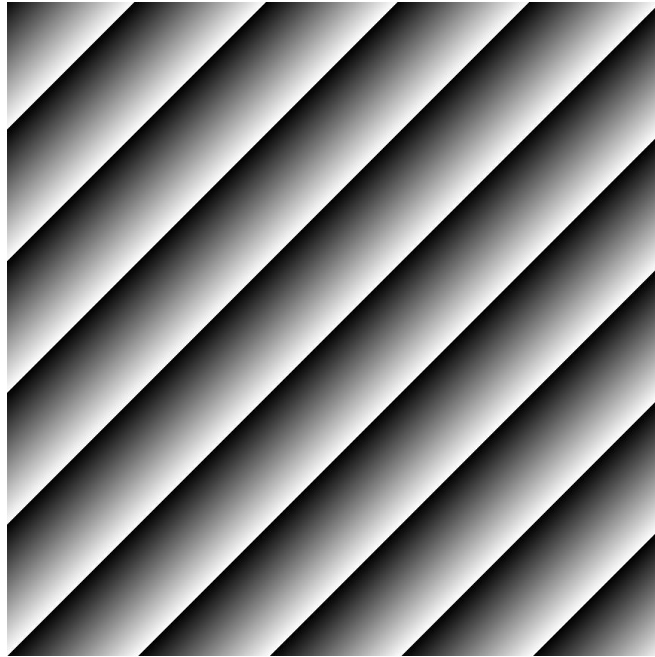

**Figure 9.16 Grey Diagonal Ramp**

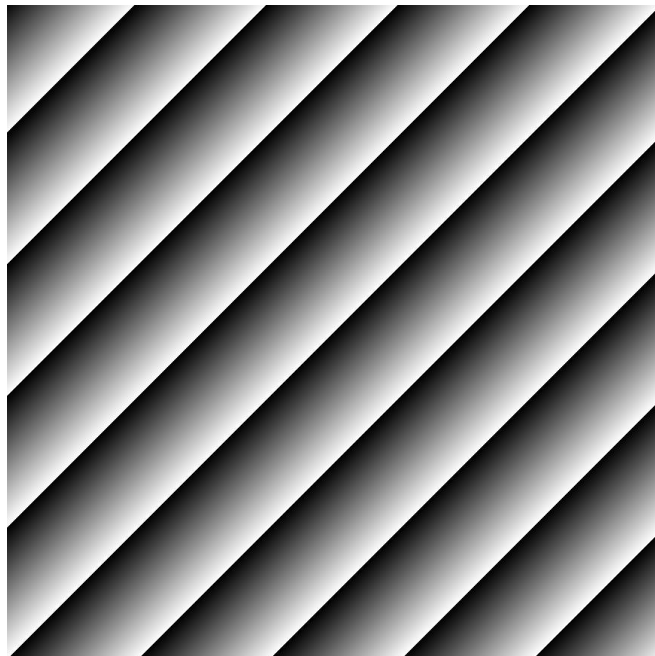

**Figure 9.17 Grey Diagonal Ramp Moving**



**Figure 9.18 Sensor Specific**



The test pattern may look different because the region of the test pattern may vary depending on the camera's resolution.

## 9.19 Reverse X

The Reverse X feature lets you flip images horizontally. This feature is available in all operation modes of the camera. The XML parameter related to Reverse X is as follows.

XML Parameters		Value	Description
ImageFormatControl	ReverseX	FALSE	Disables the Reverse X feature.
		TRUE	Flips images horizontally.

Table 9.24 XML Parameter related to Reverse X



Figure 9.19 Original Image

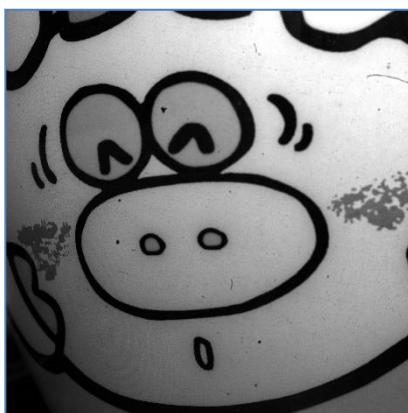

Figure 9.20 Reverse X Image



## 9.20 Reverse Y

The Reverse Y feature lets you flip images vertically. This feature is available in all operation modes of the camera. The XML parameter related to Reverse Y is as follows.

XML Parameters		Value	Description
ImageFormatControl	ReverseY	FALSE	Disables the Reverse Y feature.
		TRUE	Flips images vertically.

Table 9.25 XML Parameter related to Reverse Y



Figure 9.21 Original Image



Figure 9.22 Reverse Y Image



- When you use the **Reverse Y** feature, you must generate the camera's correction data (Defective Pixel Map, DSNU and PRNU) again.
- When the **Pixel Format** parameter is set to **Bayer** and the **Reverse Y** feature is enabled on the color camera, the alignment of the color filter will be changed.

## 9.21 Device User ID

You can input user defined information up to 16 bytes.

The XML parameter related to Device User ID is as follows.

XML Parameters		Description
DeviceControl	DeviceUserID	Input user defined information (16 bytes).

**Table 9.26 XML Parameter related to Device User ID**

## 9.22 Device Reset

Resets the camera physically to power off and on. You must configure a link again because the camera will be released from the link between the camera and CXP Frame Grabber after reset.

The XML parameter related to Device Reset is as follows.

XML Parameters		Description
DeviceControl	DeviceReset	Resets the camera physically.

**Table 9.27 XML Parameter related to Device Reset**

## 9.23 Field Upgrade

The camera provides a feature to upgrade the Firmware and FPGA logic through the CoaXPress 2.0 interface rather than disassemble the camera in the field. Refer to [Appendix B](#) for more details about how to upgrade.

## 9.24 User Set Control

You can save the current camera settings to the camera's internal Flash memory. You can also load the camera settings from the camera's internal Flash memory. The camera provides two setups to save and three setups to load settings. The XML parameters related to User Set Control are as follows.

XML Parameters	Value	Description	
UserSetControl	UserSetSelector	Default	Selects the Factory Default settings.
		UserSet1	Selects the UserSet1 settings.
		UserSet2	Selects the UserSet2 settings.
	UserSetLoad	-	Loads the User Set specified by User Set Selector to the camera.
	UserSetSave	-	Saves the current settings to the User Set specified by User Set Selector. <ul style="list-style-type: none"> <li>The Default is a Factory Default Settings and allowed to load only.</li> </ul>
	UserSetDefault	Default	Applies the Factory Default settings when reset.
		UserSet1	Applies the UserSet1 when reset.
		UserSet2	Applies the UserSet2 when reset.

**Table 9.28 XML Parameters related to User Set Control**

The camera settings stored in the Default can be loaded into the camera's workspace, but cannot be changed. The settings set in the workspace will be lost if the camera is reset or powered off. To use the current setting values in the workspace after a reset, you must save the settings to one of the user spaces.

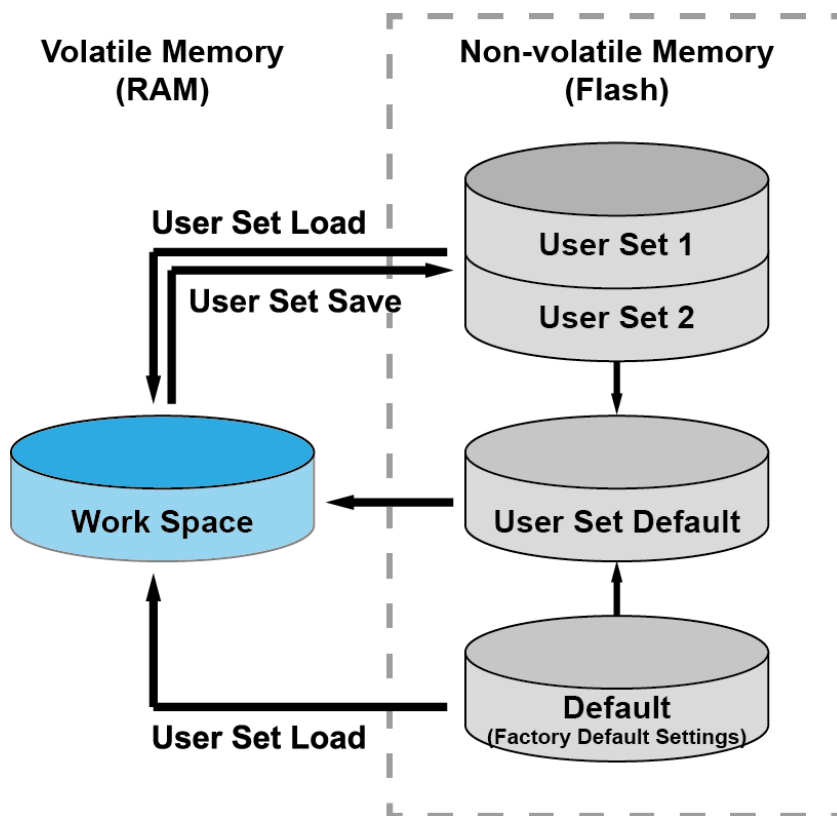

Figure 9.23 User Set Control

## 10 Troubleshooting

When you have a problem with a Vieworks camera, please check the following:

- If no image is displayed on your computer,
  - Ensure that all the cable connections are secure.
  - Ensure that the power supply is properly connected.
  - Ensure that trigger signals are applied correctly when you operate the camera with trigger signals.
- If images are not clear,
  - Ensure the camera lens or glass is clean.
  - Check the lens aperture is adjusted properly.
- If images are dark,
  - Ensure the camera lens is not blocked.
  - Check the exposure time is set properly.
  - Check the aperture is opened properly.
  - Check the Gain value is not set too small.
- If you identify abnormal operation or overheating sign,
  - Ensure the power supply is properly connected.
  - Stop using the camera when you notice smoke or abnormal overheating.
- If you have a problem using the Trigger Mode,
  - Ensure that the Software trigger related parameters are configured correctly.
  - Ensure that the trigger related parameters on your CXP-12 Frame Grabber are configured correctly when you set the Trigger Source parameter to Link Trigger0.
  - Ensure that cable connections are secure when you set the Trigger Source parameter to Line0.
- If there is communication failure between the camera and computer,
  - Ensure coax cables are connected properly.
  - Ensure that you have configured a CXP-12 Frame Grabber in your computer correctly and the camera is connected properly to the CXP-12 Frame Grabber.

## Appendix A Defective Pixel Map Download

1. Create the Defective Pixel Map data in Microsoft Excel format as shown in the left picture below and save as a CSV file (\*.csv). The picture in the right shows the created Excel file opened in Notepad. The following rules need to be applied when creating the file.
  - Lines beginning with ':' or '--' are treated as notes.
  - You must enter the horizontal value first and then vertical value for coordinates of each defect pixel.
  - Coordinate values for each pixel can be placed in any order.

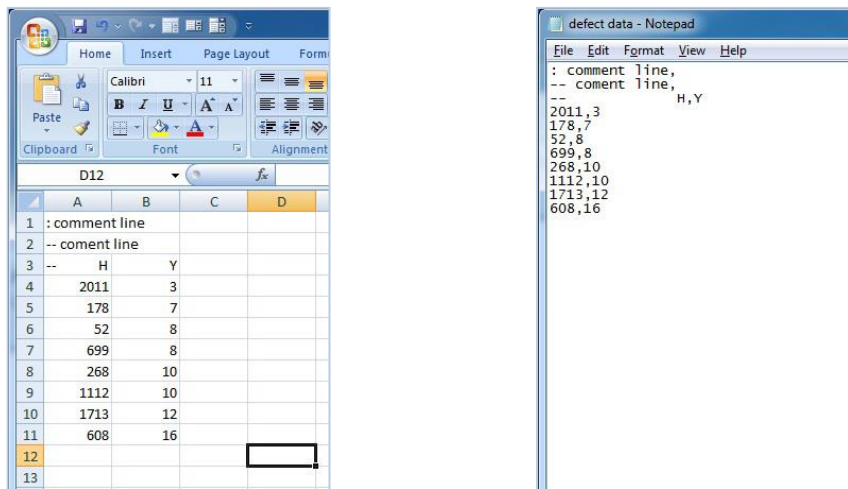

2. Run Vieworks Imaging Solution 7.X and click the **Configure** button to display the window as shown below. Select the **Defect** tab, click the File Path button, search and select the defective pixel map (\*.csv), and then click the **Download** button.

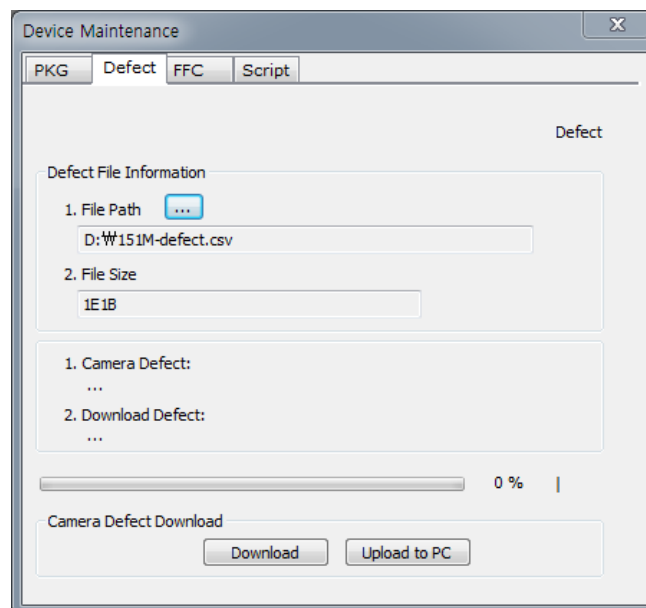

- Once the download is complete, the saving process will begin. During the saving process, make sure not to disconnect the power cord.

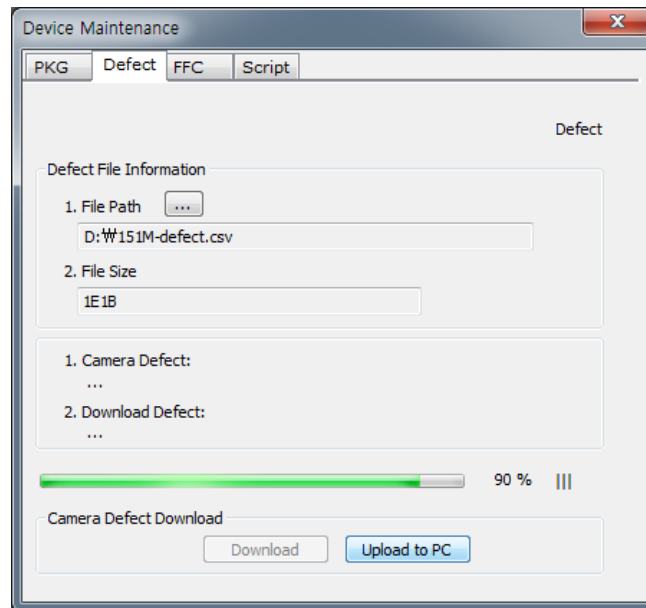

- After completing the download, click the **OK** button to close the confirmation.

## Appendix B Field Upgrade

You can upgrade the MCU, FPGA and XML file of the camera by following the procedure below.

1. Run Vieworks Imaging Solution 7.X and click the **Configure** button to display the window as shown below.
2. Select the **PKG** tab, click the File Path button, search and select the MCU, FPGA or XML upgrade file, and then click the **Download** button.

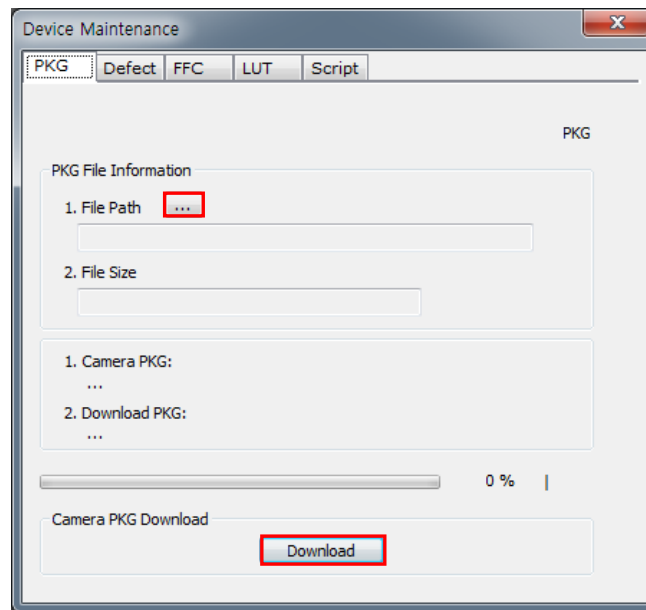

3. The camera begins downloading the upgrade file and the downloading status is displayed at the bottom of the window.

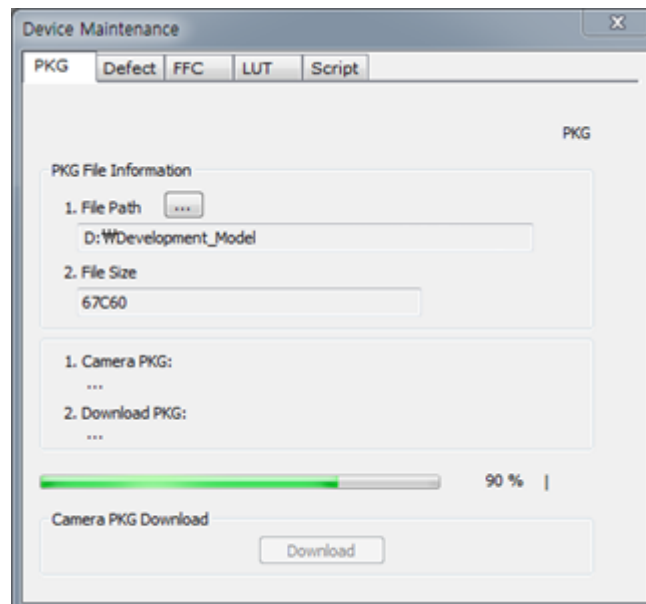



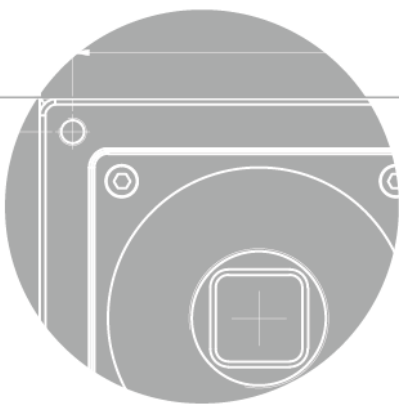
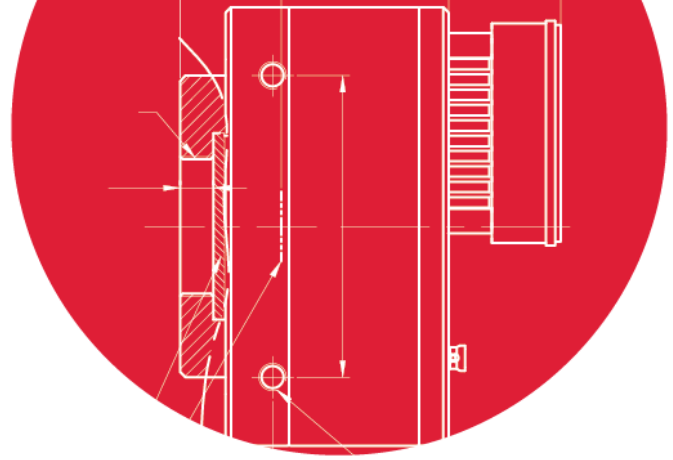

## Vieworks Co., Ltd.

41-3, Burim-ro, 170beon-gil,  
Dongan-gu, Anyang-si, Gyeonggi-do  
14055 Republic of Korea

Tel: +82-70-7011-6161

Fax: +82-31-386-8631

<http://www.vieworks.com>

[vision@vieworks.com](mailto:vision@vieworks.com)