



OPTO ENGINEERING



INSTRUCTIONS MANUAL

LTCLHP series

Telecentric HP illuminators



LIGHTING

Table of contents

1. Product overview	pag. 3
2. Instructions for use	pag. 4
2.1 Operation options	pag. 4
2.2 LED source axial position	pag. 5
2.3 How to replace the LTSCHP module	pag. 6
2.4 How to replace the LED1W source	pag. 9
2.5 CPDPH01 – diffusing cap accessory for LTSCHP1W	pag. 10
3. CE conformity.....	pag. 13

1. Product overview

LTCLHP series are high performance telecentric illuminators featuring excellent illumination stability, precise light intensity tuning and easy replacement of the LED source, specifically designed to back illuminate objects imaged by telecentric lenses.

LTCLHP telecentric illuminators offer higher edge contrast when compared to diffused back light illuminators and therefore higher measurement accuracy.

This type of illumination is especially recommended for high accuracy measurement of round or cylindrical parts where diffusive back lighting would offer poor performances because of the diffuse reflections coming from the edges of objects under inspection.

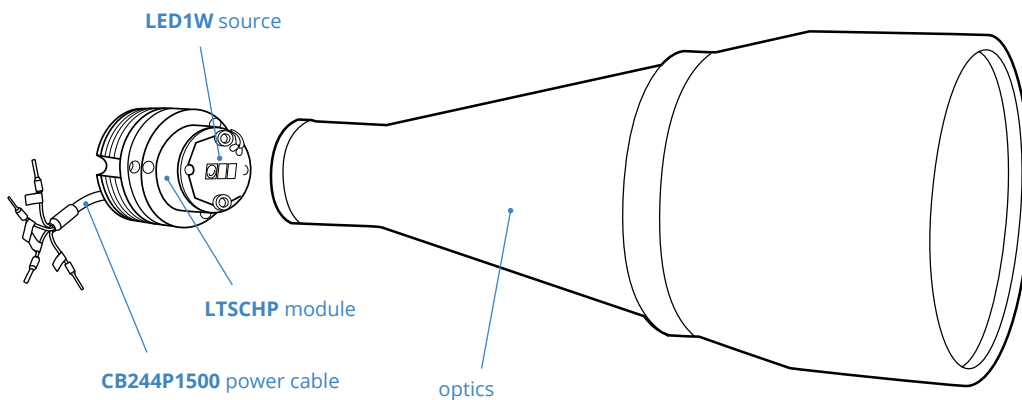

2. Instructions for use

2.1 Operation options

LTCLHP telecentric illuminators integrate LTSCHP modules as light sources. LTSCHP LED modules can be operated in two ways:

- **standard** usage option: through the built-in electronics
- **direct LED control** usage option

Part number	Light color, Wavelength peak	Device power ratings				LED power ratings			Compatibility
		DC voltage ¹		Power consumption (W)	Max LED forward current (mA) ²	Forward voltage		Max pulse current (mA) ⁵	
		Minimum (V)	Maximum (V)			Typical (V) ³	Maximum (V) ⁴		
1W power sources									
LTSCHP 1W-R	red, 630 nm	12	24	< 2.5	350	2.4	3.00	2000	LTCLHP, LTCLHP CORE, LTCL4K, TCCX, TCCXQ, TCBENCH, TCBENCH CORE, MZMT12X ⁶
LTSCHP 1W-G	green, 520 nm	12	24	< 2.5	350	3.3	4.00	2000	
LTSCHP 1W-B	blue, 460 nm	12	24	< 2.5	350	3.3	4.00	2000	
LTSCHP 1W-W	white	12	24	< 2.5	350	2.78	-	2000	

¹ Tolerance ±10%.

² Used in continuous (not pulsed) mode.

³ At max forward current.

⁴ Tolerance is ±0.06V on forward voltage measurements.

⁵ At pulse width ≤ 10 ms, duty cycle ≤ 10% condition.

Built-in electronics board must be bypassed (see tech info).

⁶ Some part numbers are not available in all color options (-R, -G, -B and -W). See page of each product series for available colors.

2.1.1 STANDARD usage option (LED control through built-in electronics)

Only continuous mode (constant voltage) is allowed.

Connection

Connect the black and brown cables to your +12 / +24 V power supply.

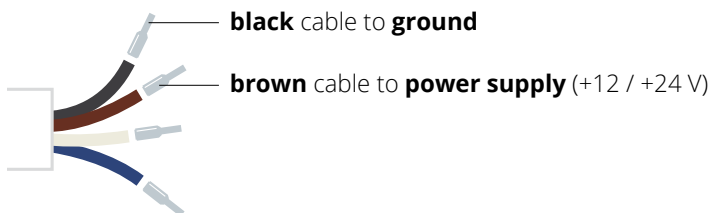

Light intensity adjustment

The built-in multi-turn trimmer allows to control the light (LED forward current) intensity with a very high degree of precision: you can bring the current intensity from minimum to maximum with 21 full turns of the adjustment screw. Simply remove the protective cap and rotate **counter-clockwise** the adjustment screw to increase light intensity and vice versa.

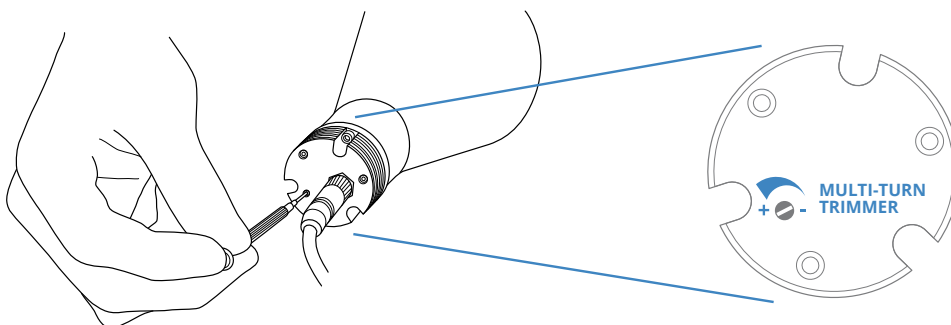

2.1.2 Direct LED control usage option

Both continuous and pulsed mode are allowed; the built-in electronics can be bypassed in order to drive the LED directly for use in continuous or pulsed mode. When bypassed, built-in electronics behaves as an open circuit allowing direct control of the LED source. Please note that in such case light intensity adjustment is not possible though the built-in multi-turn trimmer.

Connection

Connect the black and blue cables as shown below (remove the LED anode protective cover):

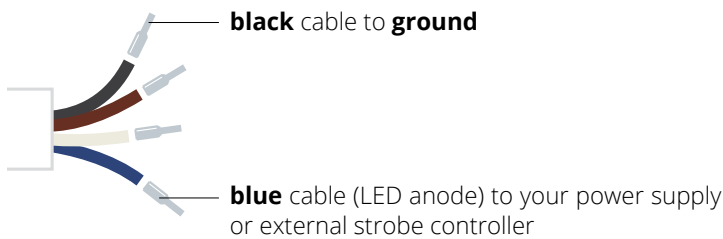

! Make sure not to exceed
 • LEDs maximum rates to avoid electrical shorts.

2.2 LED source axial position

LED axial position is an important operational parameter that must be correctly set to obtain optimal illumination homogeneity. LED axial position is adjusted at factory by placing/removing internal or external spacers of various thicknesses.

Each LTCLHPxxx illuminator is configured *by default* with the number and type of spacers needed to achieve the best illumination homogeneity with its corresponding TC12xxx telecentric lens model.

The number and type of spacers needed to achieve the optimal light homogeneity can be different when LTCLHPxxx is used in combination with TC13xxx, TC23xxx or telecentric lenses designed for other sensor sizes.

2.3 How to replace the LTSCHP module

When you receive LTSCHP module, in the package you will find the following items:

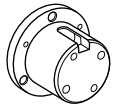

LED support (gray color)

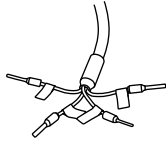

Power cable

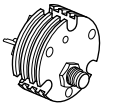

Rear part (red color)

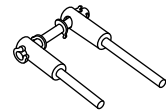

LED centering tool
to easily position
and center LED1W-x light
source

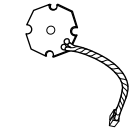

LED1W: LED source
component

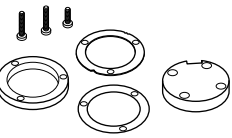

Spacers kit: includes the spacers and screws you need to
correctly configure LTSCHP1W for your specific LTCLHP model



LTSCHP module

LED source axial position is an important operational parameter: make sure to follow the instructions in the next section to obtain optimal illumination homogeneity.

! Make sure to perform this procedure in a clean, non-dusty environment in order to prevent dust or other particles from entering your LTCLHP illuminator

2.3.1 Spacers selection and placement

The number and type of spacers to place in your LTCLHP varies for each part number, depending on LED color and lens type (as shown below). When replacing a no more operational LTSCHP module or LED source, make sure to preserve the same spacers configuration of your LTCLHP unit. The following table is provided as a reference and lists the number and thickness of the spacers to be placed in order to correctly configure your LTCLHP telecentric illuminator.

Part number	Light color, wavelength peak	Theoretical LED position	Number of spacers				
			Internal	External			
			+5	-0,5	-1	-4	-5
		mm	mm	mm	mm	mm	mm
LTCLHP023-R	red, 630 nm	-					
LTCLHP023-G	green, 520 nm	-					
LTCLHP023-B	blue, 460 nm	-					
LTCLHP023-W	white	-					
LTCLHP016-R	red, 630 nm	-1.5		1	1		
LTCLHP016-G	green, 520 nm	-1.0			1		
LTCLHP016-B	blue, 460 nm	-1.0			1		
LTCLHP016-W	white	-1.5		1	1		
LTCLHP024-R	red, 630 nm	-1.5		1	1		
LTCLHP024-G	green, 520 nm	-1.0			1		
LTCLHP024-B	blue, 460 nm	-0.5		1			
LTCLHP024-W	white	-1.0			1		
LTCLHP036-R	red, 630 nm	-1.5		1	1		
LTCLHP036-G	green, 520 nm	-0.5		1			
LTCLHP036-B	blue, 460 nm	0.0					
LTCLHP036-W	white	-0.5		1			
LTCLHP048-R	red, 630 nm	-1.5		1	1		
LTCLHP048-G	green, 520 nm	0.0					
LTCLHP048-B	blue, 460 nm	+1.0	1		4		
LTCLHP048-W	white	+0.5	1	1	4		
LTCLHP056-R	red, 630 nm	-2.0			2		
LTCLHP056-G	green, 520 nm	-0.5		1			
LTCLHP056-B	blue, 460 nm	+1.0	1		4		
LTCLHP056-W	white	+0.5	1	1	4		
LTCLHP064-R	red, 630 nm	-2.0			2		
LTCLHP064-G	green, 520 nm	0.0					
LTCLHP064-B	blue, 460 nm	+1.5	1	1	3		
LTCLHP064-W	white	+1.0	1		4		
LTCLHP080-R	red, 630 nm	-2.0			2		
LTCLHP080-G	green, 520 nm	0.0					
LTCLHP080-B	blue, 460 nm	2	1		3		
LTCLHP080-W	white	+1.5	1	1	3		
LTCLHP096-R	red, 630 nm	-2.5		1	2		
LTCLHP096-G	green, 520 nm	0.0					
LTCLHP096-B	blue, 460 nm	+2.0	1		3		
LTCLHP096-W	white	+1.5	1	1	3		
LTCLHP120-R	red, 630 nm	-2.5		1	2		
LTCLHP120-G	green, 520 nm	+1.0	1		4		
LTCLHP120-W	white	+4.0	1		1		
LTCLHP144-R	red, 630 nm	-2.5		1	2		
LTCLHP144-G	green, 520 nm	+1.5	1	1	3		
LTCLHP192-R	red, 630 nm	-3.0			3		
LTCLHP192-G	green, 520 nm	+2.5	1	1	2		
LTCLHP192-W	white	7	2		3		
LTCLHP240-R	red, 630 nm	-3			3		
LTCLHP240-G	green, 520 nm	+3.5	1	1	1		

Using spacers to adjust LED axial position

Without spacers

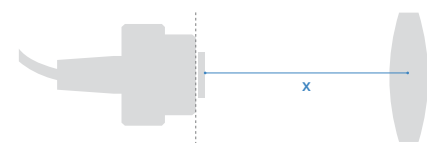

Use **internal** spacers to decrease the distance between LED and lens.

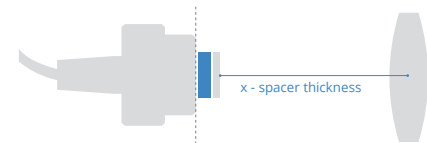

Use **external** spacers to offset the mechanical support, pushing the lens away from the LED.

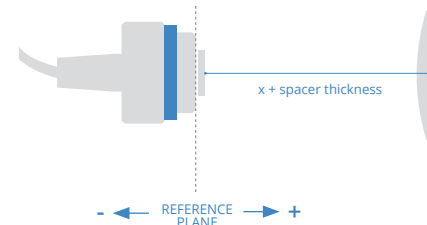

Please note that the numbers and thicknesses listed are theoretical values and are characterized by a certain variability: the number of spacers needed to achieve the optimal light homogeneity can be different from the theoretical value listed. We suggest to start from the values provided and then iterate until you achieve an homogeneous illumination.

2.3.2 Assembling instructions

Follow these steps to properly assemble the LTSCHP module.

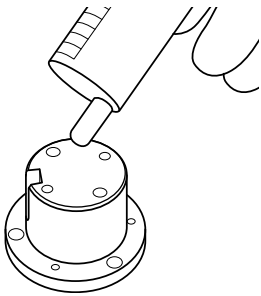

1
Apply a **small** amount of thermal grease on top of the LED support; if you are using internal spacers apply grease on both sides of the spacers. *

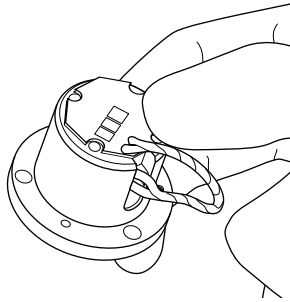

2
Position LED1W such that the black and red cables can be inserted in the lateral slot.

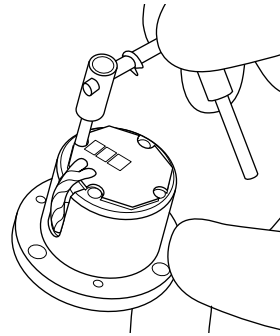

3
Insert LED centering tool, one dowel pin at a time.

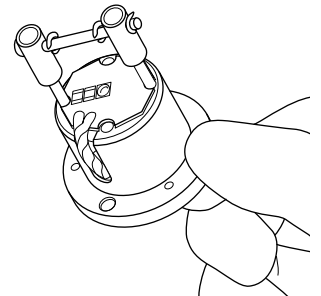

4
Now the LED1W is correctly centered and positioned.

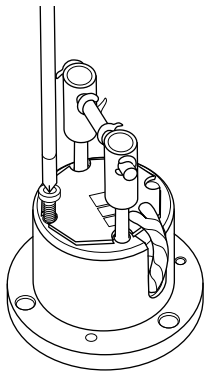

5
Lock LED1W in place with two provided screws. **

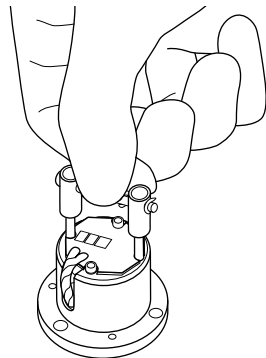

6
Pull out LED centering tool.

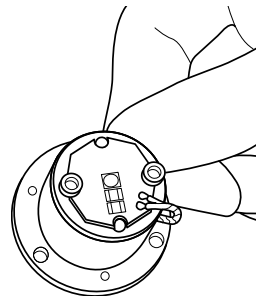

7
LED1W is now correctly positioned on the LED support.

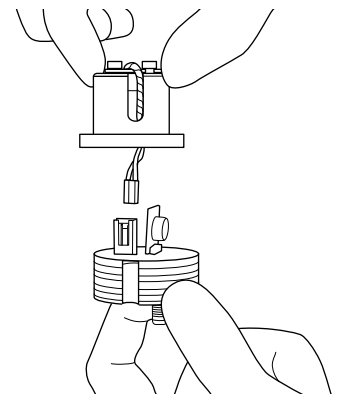

8
Insert connector.

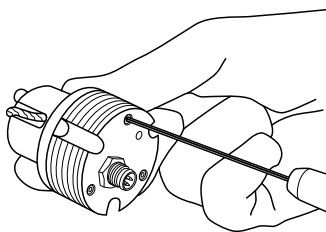

9
Connect the rear part to the LED support using the provided M2X16 screws.

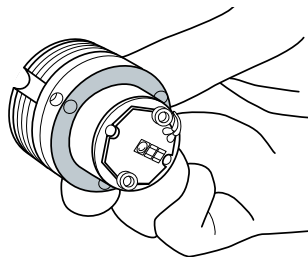

10
Insert external spacers, if needed.

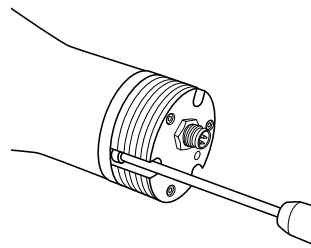

11
Screw LTSCHP module on your LTCLHP.

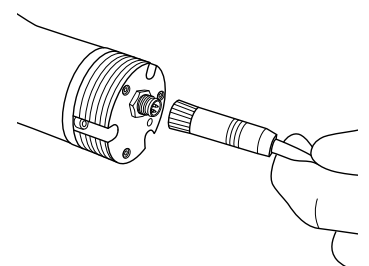

12
Connect the power cable.

* Thermal grease not provided: make sure to use an appropriate thermal grease to improve the transfer of thermal energy across the metal-to-metal interface (we suggest to use grease with thermal conductivity greater than 0.765W/mK).

** Use the screws with the appropriate length according to the presence of internal spacers.

2.4 How to replace the LED1W source

When you receive LED1W source, in the package you will find the following items:

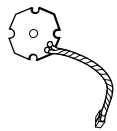

LED1W: **LED source** component

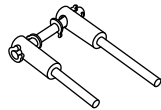

LED **centering tool** allows to easily position and center LED1W light source.



LED1W source

2.4.1 Replacement instructions

Follow these steps to properly replace LED1W source.

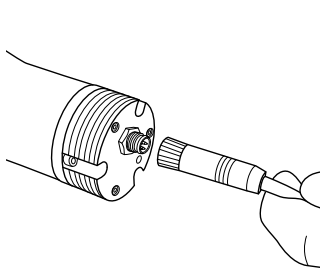

1

Turn off LTCLHP and disconnect the power cable.

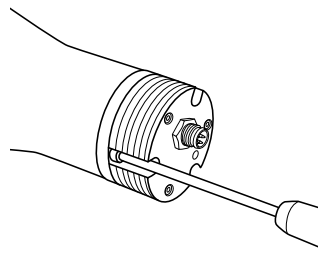

2

Unscrew the LTSCHP module from the LTCLHP illuminator.

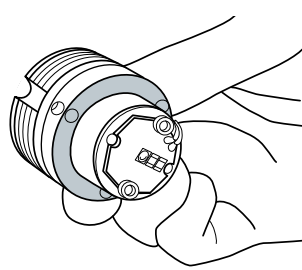

3

Remove any external spacers.

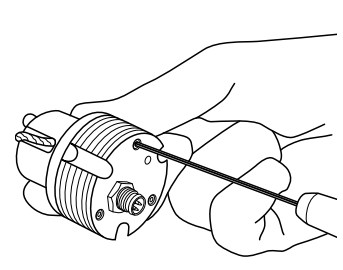

4

Unscrew and disconnect the rear part from the LED support.

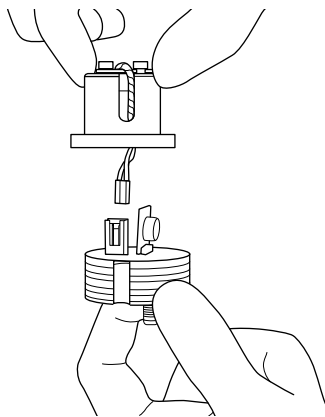

5

Unplug the connector.

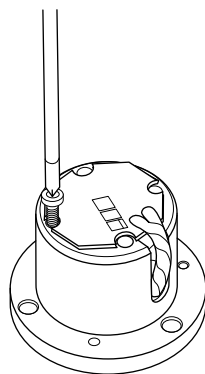

6

Unscrew and remove the old LED1W source.



Follow steps **1** to **12** of LTSCHP assembly procedure (section 2.2.2) to complete the replacement.

2.5 CPDPH01 – diffusing cap accessory for LTSCHP1W

In certain cases telecentric illuminators projecting a quasi-monochromatic light source (such as an LED) can give rise to diffraction effects. Such diffraction effects can appear in the form of ripples or “overshoots” forming nearby the edges of the feature that must be measured (such as the one displayed below) and affect image processing algorithms.

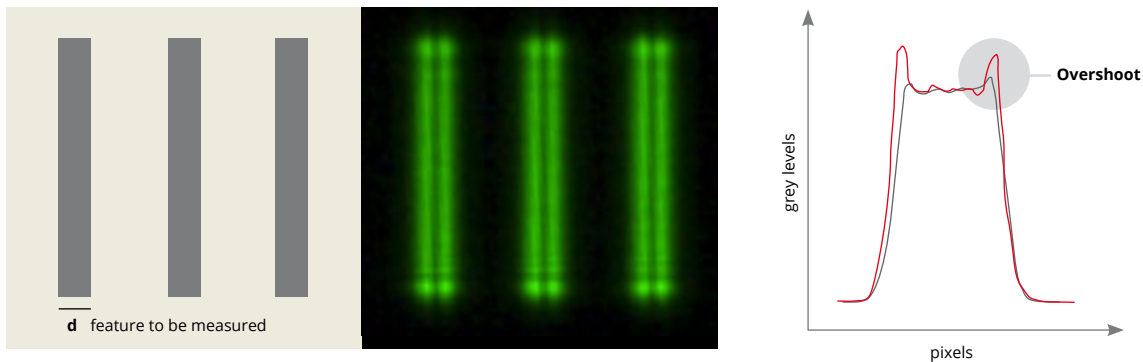

Whenever this is the case, CPDPH01 diffusing cap accessory is available (*to be ordered separately*).

CPDPH01 is an optional diffuser cap designed to be positioned in front of LTSCHP1W modules and into any LTCLHP telecentric illuminator that effectively minimizes such diffraction effects¹.

2.5.1 Assembling instructions

When you receive CPDPH01 module, in the package you will find the following items

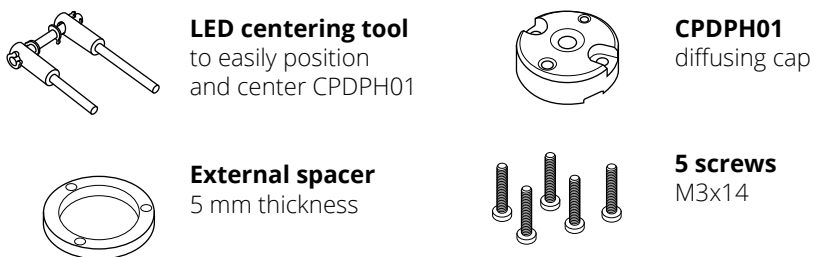

¹ CPDPH01 may affect the level of LTCLHP illumination homogeneity.

Follow these steps to properly position CPDPH01 accessory:

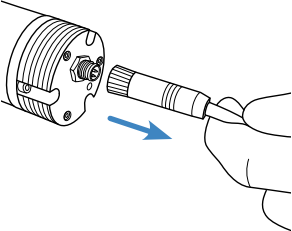
- 

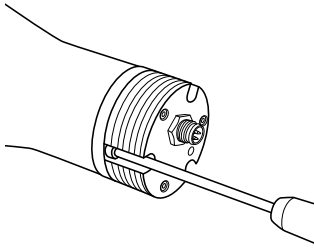
1 Turn off LTCLHP and disconnect the power cable.
- 

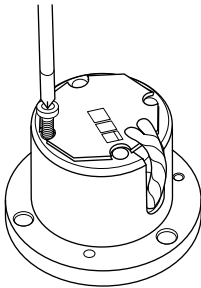
2 Unscrew the LTSCHP module from the LTCLHP illuminator.
- 

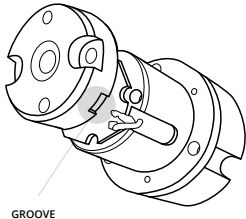
3 Unscrew LED1W source (and, if present, remove one internal spacer according to the instructions reported in 2.5.2).
- 

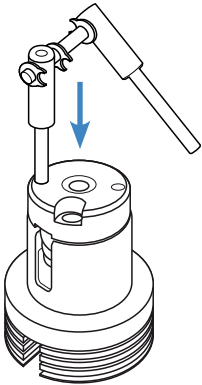
4 Position CPDPH01 on top of LED1W (groove for the cable housing must be correctly positioned).
- 

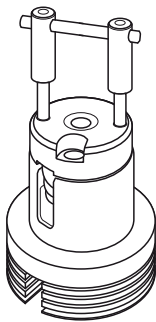
5 Insert LED centering tool, one dowel pin at a time.
- 

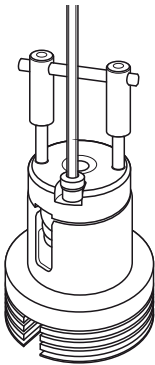
6 Now CPDPH01 is correctly centered and positioned.
- 

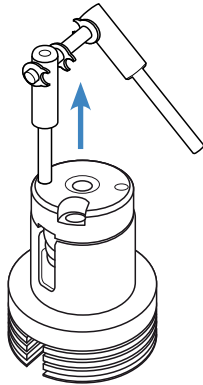
7 Lock CPDPH01 in place with two provided screws.
- 

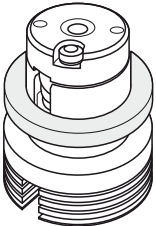
8 Pull out LED centering tool.
- 

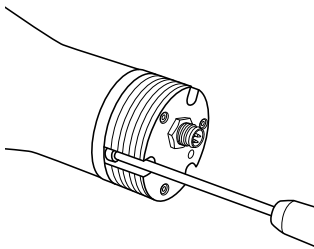
9 In case no internal spacers are present, insert the provided 5 mm external spacer to compensate for the new LED "apparent" axial position (+5 mm) 2. See 2.5.2 for details.
- 

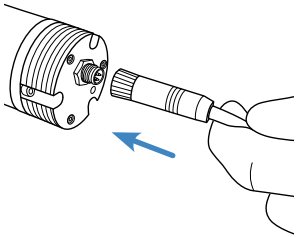
10 Screw LTSCHP1W module with CPDPH01 accessory on your LTCLHP.
- 

11 Connect the power cable.

¹ The 5 mm external spacer supplied with CPDPH01 must be placed *in addition* to other external spacers already in place and supplied by default (if present).

2.5.2 Adjustment of internal spacers configuration with CPDPH01

Placing CPDPH01 in front of LTSCHP1W virtually moves the LED axial position towards the rear lens of LTCLHP telecentric illuminators by +5 mm.

Such displacement must be compensated in order to achieve the best illumination homogeneity.

When placing CPDPH01, remove/add spacers as explained below:

Initial configuration:
LTCLHP with **no internal spacers**

Final configuration with CPDPH01



Add a 5 mm external spacer and add CPDPH01

Initial configuration:
LTCLHP with **one internal spacer**

Final configuration with CPDPH01



Remove the 5 mm internal spacer and add CPDPH01

Initial configuration:
LTCLHP with **two internal spacers**

Final configuration with CPDPH01

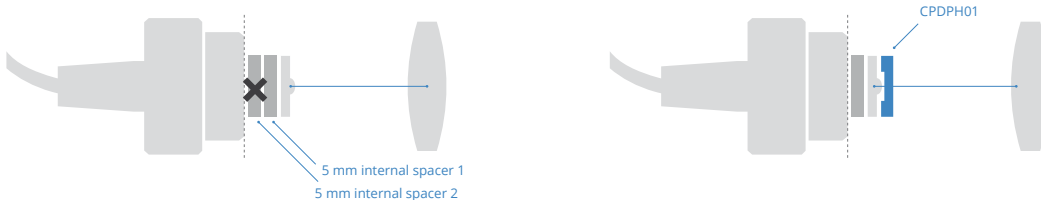

Remove a 5 mm internal spacer and add CPDPH01

3. CE Conformity

Opto Engineering declares the products of the LTCLHP and LTSCHP series compliant with the provisions of the Community Directive 2014/30/UE EN 61326-1 (measuring devices and control laboratory) including all applicable amendments, and that all standards and/or technical specifications mentioned below have been applied:

Method	Title
CEI EN 61326-1:2007-03	Electrical equipment for measurement, control and laboratory use EMC requirements. Part1: General requirements
CEI EN 55011:2011-02	Industrial, scientific and medical (ISM) radio-frequency equipment. Electromagnetic disturbance characteristics, Limits and methods of measurement
CEI EN 61000-4-3:2007-04 CEI EN 61000-4-3/A1:2009-01 CEI EN 61000-4-3/A2:2011-01 CEI EN 61000-4-3/ISI:2010-05	Electromagnetic compatibility (EMC) Part 4-3 : Testing and measurement techniques - Radiated, radio-frequency, electromagnetic field immunity test
CEI EN 61000-4-2:2011-04	Electromagnetic compatibility (EMC) Part 4-2: Testing and measurement techniques-Electrostatic discharge immunity test



OPTO ENGINEERING

www.opto-engineering.com

CONTACT US

EUROPE

Opto Engineering Europe Headquarters

Circonvallazione Sud, 15
46100 Mantova, IT
phone: +39 0376 699111
eu@opto-engineering.com

Opto Engineering Germany

Agnes-Pockels-Bogen 1
80992 München, DE
phone: +49 0 89 18930918
de@opto-engineering.com

Opto Engineering Russia

official partner
ViTec Co., Ltd, Fontanka emb., 170,
Saint-Petersburg, 198035, RU
phone: +7 812 5754591
info@vitec.ru

Opto Engineering USA

11321 Richmond Ave
Suite M-105, Houston, TX 77082
phone: +1 832 2129391
us@opto-engineering.com

ASIA

Opto Engineering China

Room 2405, n°885, Renmin RD
Huangpu District 200010
Shanghai, China
phone: +86 21 61356711
cn@opto-engineering.com

Opto Engineering Taiwan

Opto Engineering Southeast Asia LTD.
4F., No.153, Sec. 2, Shuangshi Rd.,
Banqiao Dist., New Taipei City 22043,
Taiwan (R.O.C)
phone: +886 282522188
tw@opto-engineering.com

Opto Engineering Japan

official partner
Optart Corporation
4-54-5 Kameido Koto-ku
Tokyo, 136-0071 Japan
phone: +81 3 56285116
jp@opto-engineering.com

Opto Engineering Korea

official partner
Far Island Corporation Ltd.
Seoil Building #703, 353 Sapyeong-daero,
Seocho-gu, Seoul, Korea 06542
phone: +82 70 767 86098
+82 10 396 86098
kr@opto-engineering.com