

CMTHCR096 | DATASHEET

Precision alignment mechanics for TCCRxx096, TCCRxM096-x, LTCLCR096-x



In many precision measurement applications, telecentric optics are the preferred solution. Correct alignment between the lens, the illuminator and the object plane is paramount to maximizing the telecentric effect and capabilities of the system. In order to facilitate such an alignment, Opto Engineering® designed a line of mounting mechanics featuring a tilting mechanism for an easy and precise installation, allowing small adjustments to refine the optical alignment.



SPECIFICATIONS

Mechanical specifications

Length	(mm)	176.0
Width	(mm)	176.0
Height	(mm)	17.5
Optical axis height	(mm)	-
Mass	(g)	297
Tilt axis a	(°)	± 0.8
Tilt axis b	(°)	± 0.8
Compatible CMPT Plates		-

COMPATIBILITY

This products is compatible with:

- TCCRxx096
- TCCRxM096-x
- LTCLCR096-x

AXIS REFERENCES

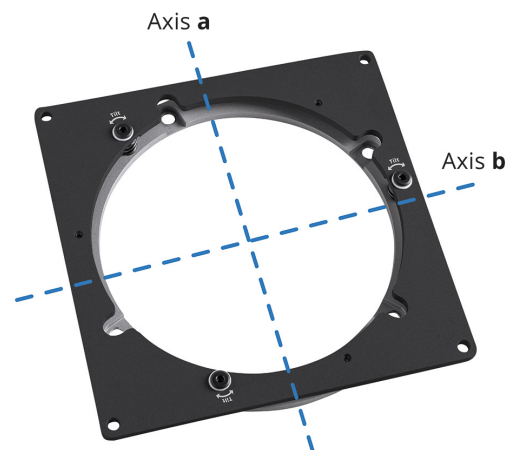

COMPATIBLE PRODUCTS

Full list of compatible products available [here](#).



A wide selection of innovative machine vision components.

All product specifications and data are subject to change without notice to improve reliability, functionality, design or other. Photos and pictures are for illustration purposes only. Data are reported by design, actual lens performance may vary due to manufacturing tolerances.