

Sprinter-FHD Sprinter-HD



User Manual

Ref. 1900-SU-02-F

About this manual

Thank you for using an Optronis product.

The purpose of this document is to provide a description of Optronis Sprinter-FHD and Sprinter-HD cameras.

Please read this manual thoroughly before operating your new camera for the first time. Please follow all instructions and observe the warnings.

This document is subject to change without notice and corresponds to the last camera firmwares and control software versions.

You can check product page download area to be sure you are using:

- Last manual version
- Last firmwares version. (Check Firmware Update paragraph)
- Last control software (TimeViewer) version

<https://optronis.com/en/products/sprinter-fhd/>

<https://optronis.com/en/products/sprinter-hd/>

Support

We hope that this manual can answer your questions, but should you have any further questions or if you wish to claim a service or warranty case, please contact your local dealer or refer to the Optronis Support on our website or by email and please prepare following information:

- Serial-Number: « S/N: 190x-ST-xxx ». See label at camera rear side.
- TimeViewer Software version
- Operating System (Windows 7/10/32bit/64bit ...)
- Short description of the problem

Contacts

To contact us, please use below information.

Address	OPTRONIS GMBH Ludwigstr. 2 D-77694 Kehl Germany Tel.: +49 (0) 78 51/91 26-0 Fax: +49 (0) 78 51/91 26-10
Website	http://optronis.com/en/
Contact Form	http://optronis.com/en/kontakt/
General Inquiries	info@optronis.com
Sales	sales@optronis.com
Support	support@optronis.com

Contents

Revision	4
General	5
Declaration of conformity	5
RoHS compliance	5
Scope of delivery	6
Safety Instructions	7
Typical System Configuration	8
Quick Start Instructions	9
Nikon F-Mount	9
To mount the Nikon F-Mount lens	9
To unmount the Nikon F-Mount lens	10
Nikon F-Mount for G lenses (/FMG)	11
Nikon G lenses	11
To mount the Nikon G lens	11
To unmount the Nikon G-Mount lens	12
Start of operation (Network / IP Address configuration)	13
Camera	16
Lens Interface	16
Camera Socket	16
Electrical Interface	17
Camera detailed view	17
SSD Slot	17
Power Switch	17
Programmable Output (PO)	18
Synchronization Output (SO)	18
Firmware Slot (FW)	18
GigE / USB2 Connector	18
Power Connector	18
SSD Slot Mounting Screw	18
Trigger Input (TI)	19
Synchronization Input (SI)	19
LED A / LED B	19
IRIG B Input	20
Serial Number	20
SSD Slot operating	21
Unmount SSD	21
Mount SSD	21
Trigger (TI) / Sync Connectors (SI / SO) details	22
External Trigger (TI)	22
External TTL	22
External Switch	22
External Synchronization Input (SI)	22
Synchronization Output (SO)	23
Power Supply	24
Minimal PC configuration	24

TimeViewer Software	24
Technical Data	25
Sprinter-FHD	25
Sprinter-HD	26
Sprinter-HD Spectral Response (Quantum Efficiency Mono Sensor)	27
Performance (Examples)	28
Sprinter-FHD	28
Sprinter-HD	28
Mechanical Dimensions	29
Sprinter Series (/FM, /FMG)	29
External Inputs	31
Trigger & Synchronization input	31
Synchronization Timing	31
Trigger Timing	31
External Outputs	32
Synchronization output	32
Synchronization Timing	32
Firmware Update	33
Why updating camera firmwares	33
How to update camera firmwares	34

Table of figures

Figure 1: Typical System Configuration with PC and GigE connection	8
Figure 2: Typical System Configuration with PC and WIFI connection	Fehler! Textmarke nicht definiert.
Figure 3: Overall Camera and lens view	9
Figure 4: F-lens mount 1/2	9
Figure 5: F-lens mount 2/2	10
Figure 6: F-lens unmount	10
Figure 7: FMG lens	11
Figure 8: G lens mount1/2	12
Figure 9: G lens mount 2/2, Lens locked	12
Figure 10: G-lens unmount	12
Figure 11: Camera detection	14
Figure 12: Sprinter Camera View	16
Figure 13: Sprinter camera electrical interface	17
Figure 14: SSD and its holding system	21
Figure 15: Trigger Input, schematic presentation	22
Figure 16: Synchronization Input, schematic presentation	22
Figure 17: High impedance termination	23
Figure 18: 50 Ohm termination	23
Figure 19: Spectral Response Curve	27
Figure 20: Bottom view	29
Figure 21: Side view	29
Figure 22: Top view	30
Figure 23: Front view	30
Figure 24: Input synchronization timing	31
Figure 25: Trigger timing	31
Figure 26: Output synchronization timing	32
Figure 27: TimeViewer detects an out of date camera firmware	33
Figure 28: Select files and path	35
Figure 29: Copy files to USB stick	35
Figure 30: Connected to camera	35
Figure 31: HW Update progressing 1/2	35
Figure 32: HW Update progressing 2/2	36
Figure 33: Update finished	36
Figure 34: New HW is loaded at next power cycle	36

Revision

Manual revision	Date	Comments
1900-SU-02-F	09.07.2019	- Minor corrections
1900-SU-02-E	26.03.2019	- Minor corrections - New minimum Sprinter FHD minimum exposure (4 μ s) - New minimum FPS (50fps)
1900-SU-02-D	10.12.2018	- Rename CR-S3500 to Sprinter-HD - Add Sprinter-FHD model
1900-SU-02-C	28.09.2017	- Update content
1900-SU-02-B	29/03/2017	- Update layout - Add Firmware update paragraph
1900-SU-02-A	28/02/2017	- 1 st version

General

Declaration of conformity

Manufacturer: Optronis GmbH
Address: Ludwigstr. 2, 77694 Kehl, Germany

We certify and declare under our sole responsibility that the following apparatus

Product: Sprinter-FHD or Sprinter-HD
Conforms with the essential requirements of the EMC Directive 2014/30/EU, based on the following applied specifications:

Specifications:	EN 61000-6-3	Emission
	EN 61000-6-1	Immunity

Kehl, 24.02.2017

Optronis GmbH
Dr. Patrick Summ
Managing Director

RoHS compliance



Sprinter series cameras are Pb free manufactured.

Scope of delivery

A Sprinter High-Speed camera:

Options: /C: Color sensor (Bayer Pattern)
 (IR Cutoff Filter, Specification: 1830-SS-10)

 /M: Monochrome sensor

 /16GB: 16 GByte Memory

 /256GB_SSD: 256GByte SSD for Backup

 /512GB_SSD: 512GByte SSD for Backup

Lens mount: /CM: CMount

 /FM: FMount

 /FMG: FMount and Nikon G-Lenses

Power supply: +12Volt / 3,75Amp., 100 ... 240VAC/50-60Hz

User Manual, TimeViewer software (CD-ROM), 256GByte SSD,

GigE cable, USB stick, SSD connection cable

Trigger / Sync BNC adapter cables

Safety Instructions

- Please operate Sprinter cameras from a 110 Volt to 240 Volt (50 Hz to 60 Hz A.C. frequency) power source. Other voltage levels or frequencies may damage the camera.
- Do not orientate the optical input of the camera to direct sunlight.
- Keep the camera free protected from dirt, dust, grease and water.
- Make sure that all the connecting cables are in good condition and that they are well mounted to their sockets.
- Please use the socket of the camera and connect it to a sufficiently stable basis.
- Avoid strong system shocks and vibrations during transport or during operation.
- Always unplug the camera before cleaning it. Do not use cleaning liquids or sprays. Instead, use a dry and soft duster.
- For any further questions, please do not hesitate to contact Optronis GmbH, especially when the camera does not work as it is described in the user manual.

Typical System Configuration

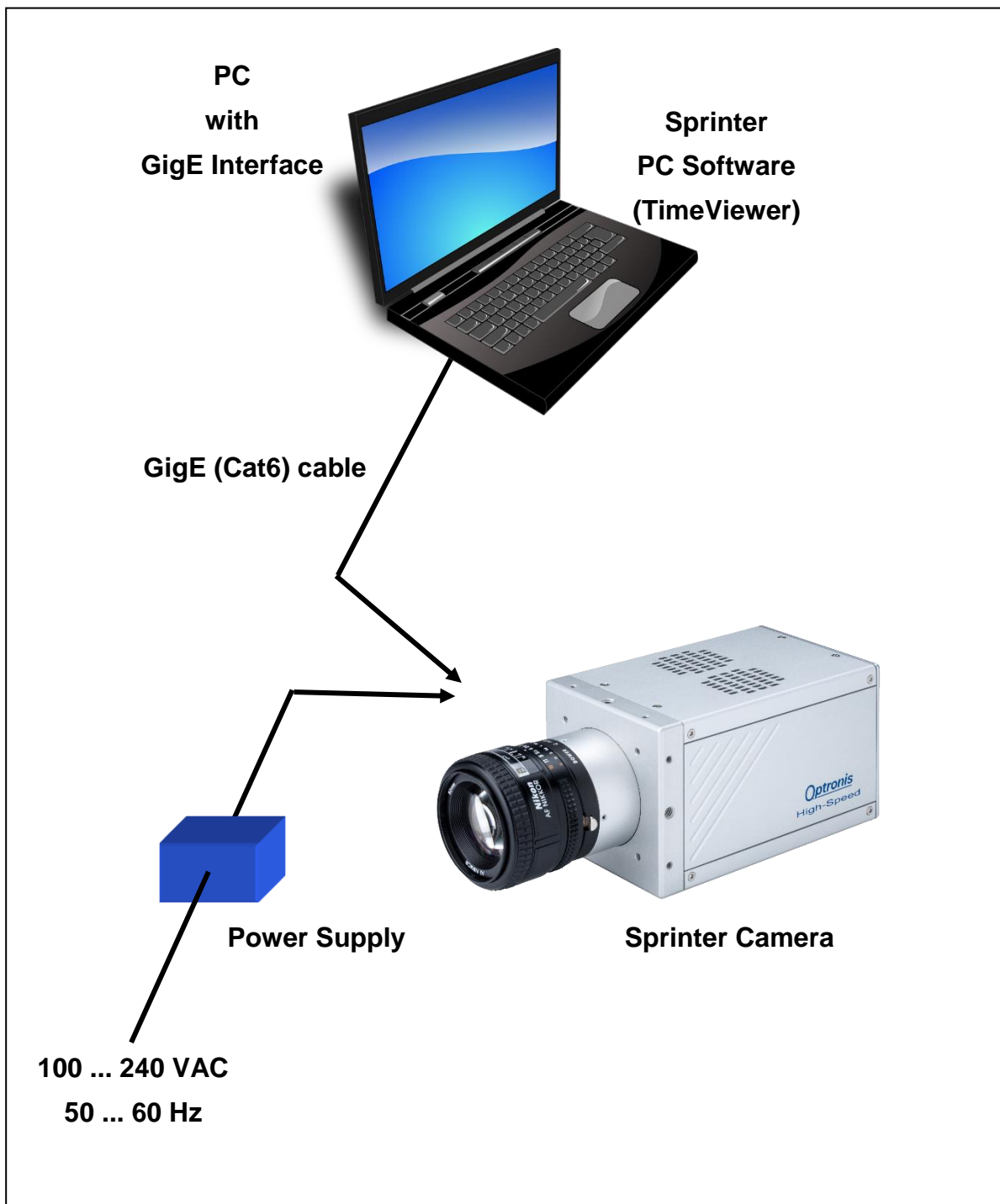

Figure 1: Typical System Configuration with PC and GigE connection

Quick Start Instructions

Nikon F-Mount

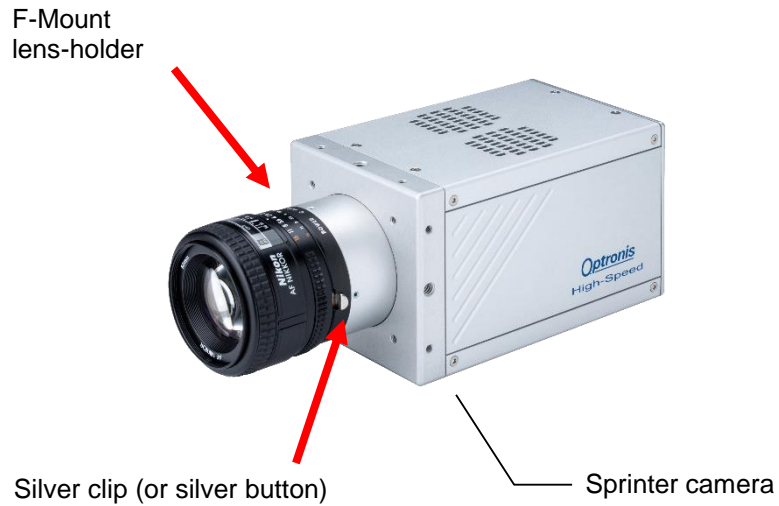

Figure 2: Overall Camera and lens view

To mount the Nikon F-Mount lens

To connect properly the lens to the lens-holder, first put the lens-reference in front of the lens-holder reference. Then, turn the lens anti-clockwise until the silver clip (silver button) on the lens-holder locks.

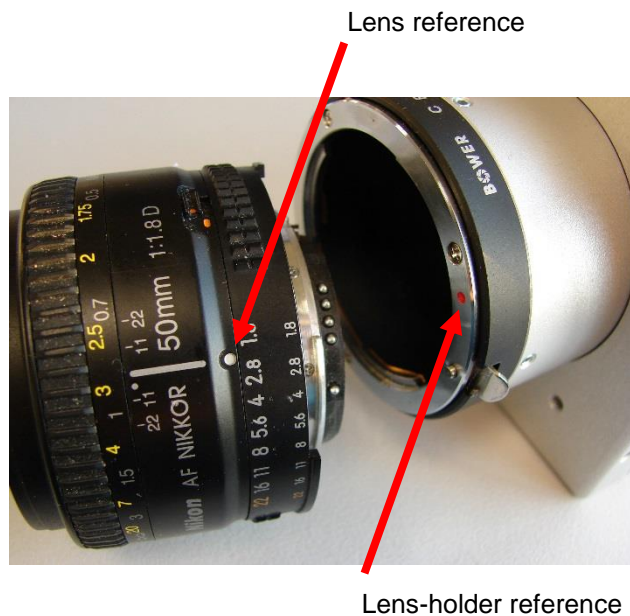

Figure 3: F-lens mount 1/2

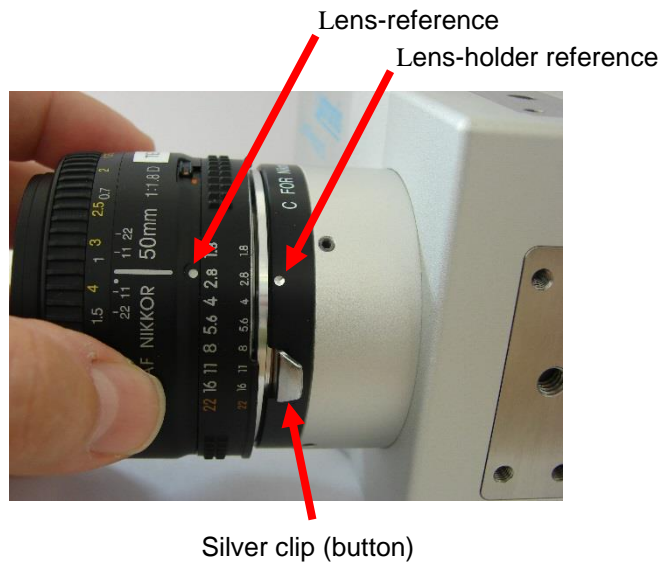

Figure 4: F-lens mount 2/2

To unmount the Nikon F-Mount lens

To unmount the lens please pull back first the silver clip (button) back in order to unlock the lens. Then the silver clip has still to be pulled back- the lens has to be turned clockwise until the lens is unmounted completely.



Figure 5: F-lens unmount

Nikon F-Mount for G lenses (/FMG)

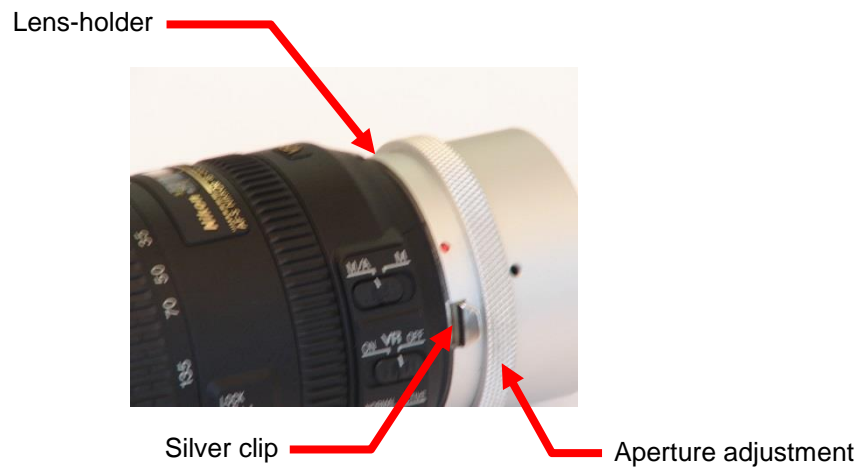

Figure 6: FMG lens

Nikon G lenses

Nikon G lenses are optimized for digital photography but do not offer mechanical aperture adjustment. The Nikon /FMG Adapter allows even with these lenses to perform mechanical aperture adjustment by use of an adjustment ring on the lens holder. The adjustment of the aperture is performed continuously.



When mounting a standard F-Mount lens (with mechanical aperture ring) onto the /FMG adapter, please pay attention, that the aperture ring on the adapter don't affects the aperture adjustment on the lens. Please turn the aperture ring of the adapter clock-wise (seen from the front) to its mechanical stop.

To mount the Nikon G lens

To connect properly the lens to the lens-holder, first put the lens-reference in front of the lens-holder reference. Then, turn the lens anti-clockwise until the silver clip (silver button) on the lens-holder locks.

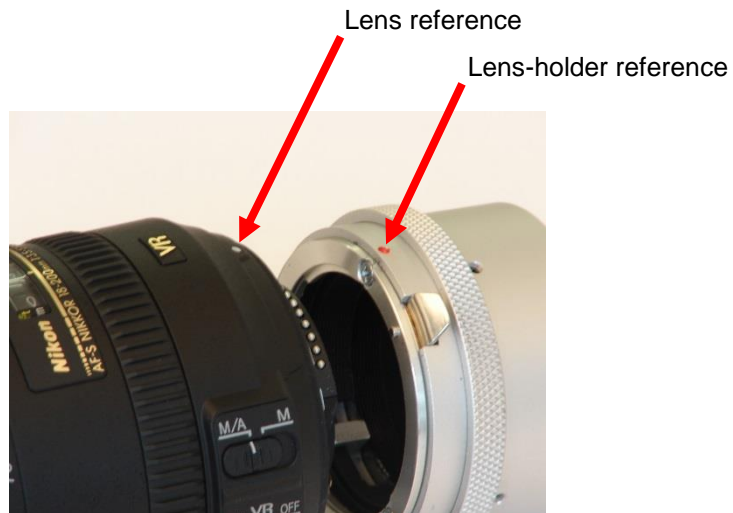

Figure 7: G lens mount1/2

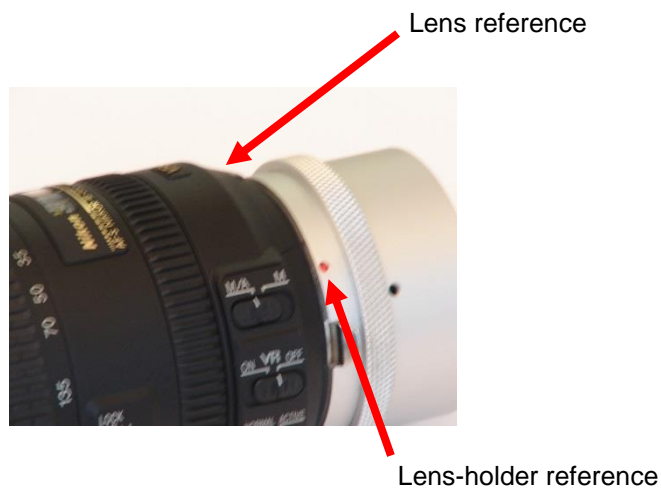

Figure 8: G lens mount 2/2, Lens locked

To unmount the Nikon G-Mount lens

To unmount the lens please pull back first the silver clip back in order to unlock the lens. Then -the silver clip has still to be pulled back- the lens has to be turned clockwise until the lens is unmounted completely.



Figure 9: G-lens unmount

Start of operation (Network / IP Address configuration)

1. Please connect the camera power supply to the power connector of the Sprinter camera and then connect the power supply to the 110-240 Volt power source. The camera will operate after switch on the power switch on the camera backside (I..0) to position (I).

Make sure, that your PC has a Gigabit Ethernet (GigE) interface. To operate a Sprinter camera, please set both camera and PC network adapter on the same subnetwork:



Please note, that the IP Address may either be changed in the Personal Computer (Network card) or in the camera or both.

To set the IP Address in the Personal Computer please ask your System Administrator.

To set the IP Address of the camera please use an USB2 Stick formatted to **FAT32** and use the Optronis tool IPConfiguration:

- 1) Start IPConfiguration tool "IPConfiguration.exe" to create a text file IP.CFG
- 2) Copy IP.CFG to the USB2 Stick
- 3) Power off the camera and plug the USB2 Stick into the Sprinter camera
- 4) Power on the camera and wait, until boot time has finished (see led states detailed later in the document).
- 5) USB2 Stick can be removed once the boot is finished.

Alternatively

- 1) Create a text file on the USB2 Stick named: IP.CFG
- 2) Open the text file and write 2 lines. First Line is the IP of the camera (e.g. 192.168.100.254), second line is the Subnet mask (e.g. 255.255.255.0)
- 3) Save the file, plug it to the camera, power on the camera and wait until the camera has booted.
- 4) After boot, the camera has accepted the new IP address.

Alternatively

- 1) Plug an empty USB2 Stick to the camera

- 2) Boot the camera (During Boot time, the camera creates a file with the name CAMERA_IP.CFG, CAMERA_IP.CFG shows the actual IP address of the camera)
- 3) To enter the desired camera IP address please change IP address and Subnet mask of CAMERA_IP.CFG with a text editor
- 4) Save the file and rename it to IP.CFG
- 5) Plug the stick into the camera, power cycle the camera and wait until boot has finished.
- 6) USB2 Stick can be removed once the boot is finished.

2. After setting camera and PC on the same subnetwork, the software package “TimeViewer” can be installed.

3. When network is configured and software installed, the camera can be operated directly:

Please connect then the GigE (Cat 6) cable to the GigE connector of the PC and to the GigE connector of the camera.



Please note, that image data, that are stored inside the random memory of the camera, are lost when switching off the camera by the power switch.

The camera needs a “boot”-time of several seconds.

Then start the “TimeViewer” software on your PC.

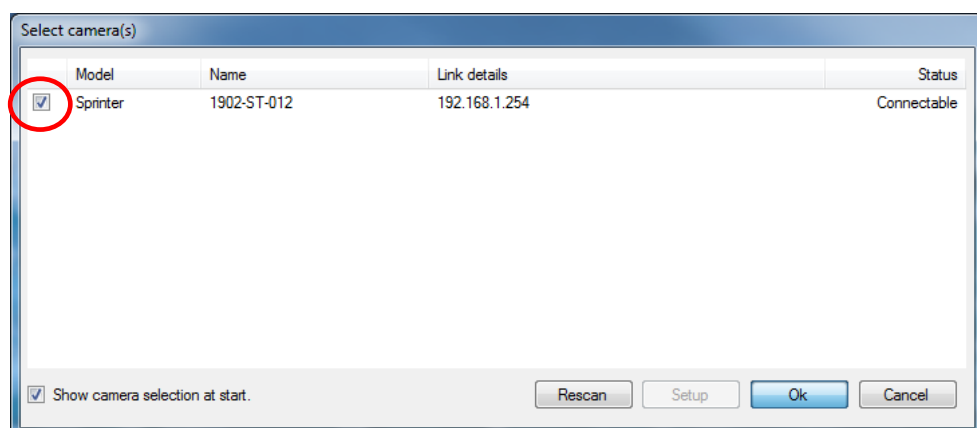



Figure 10: Camera detection

When starting the software is detecting cameras over the network. Detection results are listed (see Figure 10) and at list one camera must be selected (check tick boxes, multi-camera control is supported) before clicking on “Ok”. TimeViewer software will start automatically and will connect the PC to the camera.

In case camera booting was not finished or if the camera was not yet connected you can click on “Rescan” button to start another detection.

If you untick the check box “Show camera detection at start” the detection will be bypassed at next software start and software will try to connect to the same IP address found during last software start.

Click on “CANCEL” to exit the application.

<p>Please note, that TimeViewer “Options” menu allows to re-activate or disactivate this searching function.</p> <p>To reach “Option” menu, please click on “Extra” button in the top left corner of the main window.</p>

To verify the operation of the camera, the following parameters in the “Setup-Menu” of the software can be selected:

	Sprinter-FHD	Sprinter-HD
Frame Format:	1920 x 1080	1280 x 860
Frame Rate:	50 fps	50 fps
Exposure Time:	20000µs (ie.1/50)	20000µs (ie.1/50)
Synchronization:	internal	internal

Select then “Play / Live Image” in the “Acquisition-Menu”. The camera transfers now live-images to the monitor of the PC.

Do not forget to remove lens cap.

To optimize image quality, please adjust lens aperture and focus.

Remark:

If there is a detection/communication problem between the camera and the PC, please make sure that the camera is well power supplied and that the camera is well connected to the PC.

Please also make sure that the IP address is set correctly.

If the detection menu was bypassed, please enable it (see above note).

Please contact Optronis GmbH if the camera is not communicating with the computer.

Camera



Figure 11: Sprinter Camera View

Lens Interface

In the standard version, the Sprinter camera will be delivered with a Nikon-F Mount lens interface (Option /FM).

Remark:

For special needs, the Sprinter cameras may also be used with C-Mount (Option /CM), F-Mount for G lenses (Option /FMG). Other lens interfaces as e.g. CS-Mount and metrical formats can be chosen. Please contact Optronis GmbH.

Accessories:

Macro and magnification-applications may need special distance washers between lens interface and lens as e.g. the PK-11A (8mm length) from Nikon. Distance washers are available for Nikon F-Mount and C-Mount.

Camera Socket

The socket at the bottom side of the camera is used:

- To fasten the camera to a tripod or special holders by use of the five screw threads (1x 1/4''-20UMC in the middle or 4x M4 in the corners).
- Alternatively, the mounting holes of the camera head can be used to fasten the camera with more flexibility.

Electrical Interface

Camera detailed view



- | | |
|------------------------------------------------------------|-----------------------------------------------------|
| 1. SSD Slot | 7. Power Connector |
| 2. Power Switch | 8. SSD Slot Mounting Screw |
| 3. Programmable Output (PO)
Synchronization Output (SO) | 9. Trigger Input (TI)
Synchronization Input (SI) |
| 4. Firmware Slot | 10. LED A / LED B |
| 5. GigE / USB2 Connector | 11. IRIG B Input |
| 6. Serial Number | |

Figure 12: Sprinter camera electrical interface

SSD Slot

(1) SSD hard disk slot for non-volatile backup of the image sequences.

Power Switch

(2) The camera operates when the Power supply is connected and the Power Switch is on '1'. The Power of the camera is switched off when the Power switch is on '0'. The camera loses all sequences that are stored in volatile RAM when the camera is switched off.

Programmable Output (PO)

(3) TBD.

Synchronization Output (SO)

(3) Gives out a TTL signal synchronous to the exposure time of the images. The TTL signal is always active.

Firmware Slot (FW)

(4) Micro SD Card slot with Firmware of the camera. "Major" firmware updates need to replace the MicroSD card inside the slot.

GigE / USB2 Connector

(5) The GigE Connector is used to communicate with a PC. Please use Cat6 (or better) Patchcable between camera and PC.

The USB2 connector is used for configuring camera network setting and firmware update (USB2 stick).

Power Connector

(7) The camera is supplied by a 12 Volt DC power source which is delivered by the camera power supply. To operate the camera, the power supply has to be connected and the Power Switch has to switch on "1".

Remark:

Please always use the power supply that is foreseen for the camera. When the camera shall be supplied by another power source please contact first Optronis GmbH.

SSD Slot Mounting Screw

(8) Please switch off the camera and turn the SSD Slot Mounting Screw anti-clockwise to open the SSD slot of the camera.

Trigger Input (TI)

(9) The image sequence can be triggered (the recording will be stopped) by an external Switch or TTL signal. To use the trigger input, please refer to the TimeViewer software package.

Synchronization Input (SI)

(9) The synchronization input can be used to synchronize the exposure time of several cameras. To synchronize the cameras, a TTL level has to be applied. Please refer to the TimeViewer software package to activate the synchronization input.

LED A / LED B

(10)

Color code	Led color
O	Orange
G	Green
R	Red

State	Timing
Off	0% On
SO = Solid	100% On
SF = Slow Flash	0.5Hz (1s On, 1s Off)
FF = Fast Flash	5Hz (100ms On, 100mn Off)

Camera State	Led State	
	A	B
No power	Off	Off
1) <u>System Booting:</u>		
Camera booting	R-SO	R-SO
Booting finished (FF for 1s)	R-FF	R-FF
2) <u>Camera running</u>		
No image, live stopped		G-SO
Live mode (internal sync)		G-SF
Live mode (external sync and signal ok)		G-SF
Live mode (external sync but no sync signal)		R-SF
Waiting for trigger		O-FF
Triggered, recording sequence to DDR (internal sync)		G-FF

Triggered, recording sequence to DDR (external sync and signal ok)		G-FF
Triggered, recording sequence to DDR (external sync but no sync signal)		R-FF
Replay sequence from DDR (= not live)		G-SF
No SSD connected	O-SO	
SSD detected but not formatted	O-SF	
SSD RDY	G-SO	
SSD Saving sequence (WR SSD)	G-FF	G-FF
SSD replay (RD SSD)	G-SF	G-SO
SSD Full (no more backup possible but replay is ok)	R-SF	
SSD Error (not formatted, not detected, access error, ...)	R-SO	

IRIG B Input

(11) TBD.

Serial Number

(12)

REF: Indicates the camera model and the camera options

S/N: Indicates the serial number of the camera

SSD Slot operating

Unmount SSD

To unmount the SSD please power off the camera, open the SSD slot screw and pull the SSD out of the SSD slot. The SSD can then be put into a USB docking station connected to a PC to readout image data with the TimeViewer software.



Figure 13: SSD and its holding system

Mount SSD

To mount the SSD please switch off the power of the camera, put the SSD gently into the camera SSD slot and close the SSD slot with the SSD slot screw. Power on the camera.

Please note, that a new SSD has to be formatted first by TimeViewer software before data can be saved onto the SSD.

Trigger (TI) / Sync Connectors (SI / SO) details

External Trigger (TI)

The external trigger input can be used to trigger a sequence. The schematic below shows the input schematic of the input.

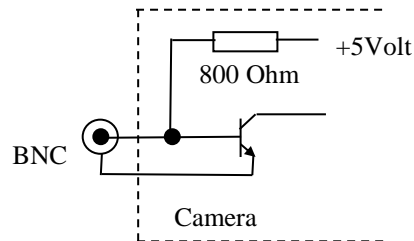

Figure 14: Trigger Input, schematic presentation

Please look at the “Technical Data / External Input” chapter of this manual for detailed technical specification.

External TTL

Allows to use a TTL signal at the BNC connector of the trigger input. The trigger is rising edge sensitive.

External Switch

Allows to use an external switch, a TTL signal or an open collector to trigger the sequence. The trigger signal is falling edge sensitive which means, that e.g. the switch has to be closed to trigger the sequence.

External Synchronization Input (SI)

The camera allows to be externally synchronized by an external pulse generator to frame rates, which are not given by the internal frame rates of the camera. To do this, a TTL signal has to be applied to the external Synchronization input. The camera detects the rising edge of the signal.

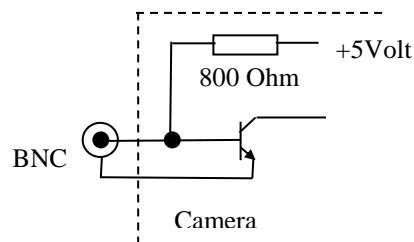

Figure 15: Synchronization Input, schematic presentation

Please look at the “Technical Data / External Input” chapter of this manual for detailed technical specification.

Synchronization Output (SO)

The Synchronization output gives out a TTL signal synchronous to the frame rate of the camera. The positive edge is synchronous to the beginning of the exposure time of each frame.

Output Impedance: 50 Ohm.

Signal Level: approx. 4 Volt into high impedance (> 500Ohm)
 approx. 2 Volt into 50 Ohm

Example for high impedance termination:

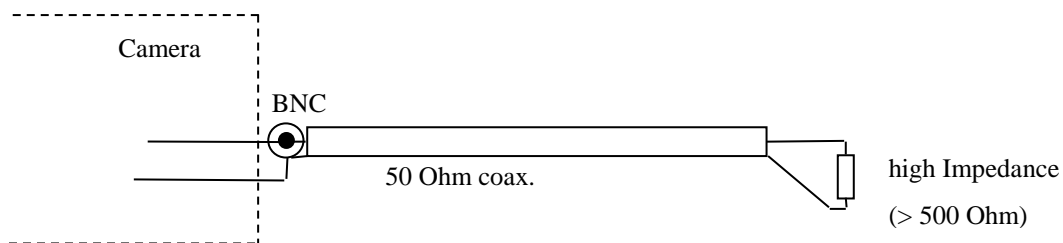

Figure 16: High impedance termination

Example for 50 Ohm termination:

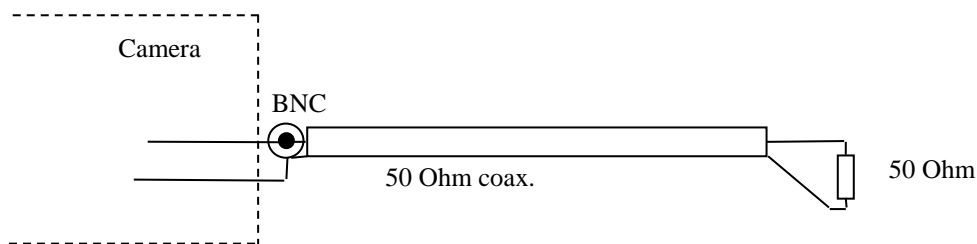

Figure 17: 50 Ohm termination

Power Supply

The power supply accepts 110 to 220 Volt input voltage at an input frequency of 50 to 60 Hz. It transforms this voltage to 12 Volt dc with a precision of better +/- 5%.

Minimal PC configuration

The PC should offer the following min. configuration:

TimeViewer Software:

Windows 7, 8, 10 (32 or 64bits)

Large Hard disk (e.g. 1 TBytes)

Performant Processor and Graphics card

For optimum performance and best display on the monitor we recommend to use highest-performance graphic boards.

TimeViewer Software

The TimeViewer software can be used to operate one Sprinter cameras in an application. The TimeViewer Software supports all Sprinter cameras. Please look in the TimeViewer Software user manual for the actual software feature list.

Technical Data

Sprinter-FHD

Sensor resolution	1920 × 1080
Frame rate @ max. sensor res.	50 .. 1 908 fps
Memory	16 GB internal
Image sensor	CMOS, Global Shutter
Exposure time	4 μs - 1/framerate
Active area	19.2 mm x 10.8 mm
Sensor diagonal dimension	22.0 mm
Pixel size	10.0 μm
A/D conversion	8 Bit
Dynamic	48 dB
Sensitivity	20 V/lux × s @ 550 nm
Trigger modes	internal free-run, switch, rising or falling edge, pre- and post-trigger
Power	12 VDC
Weight	1400 g without mount
Dimensions	150 mm x 92 mm x 92 mm
Housing	lightweight anodized aluminum
SSD bay	data storage and backup
PC software	TimeViewer for Windows (support for version 7, 8 and 10) for capture, video playback, export, export, image analysis with object tracking

Sprinter-HD

Sensor resolution	1280 × 860
Frame rate @ max. sensor res.	50 .. 3504 fps
Memory	16 GB internal
Image sensor	CMOS, Global Shutter
Exposure time	2 μs - 1/framerate
Active area	17.5 mm x 11.8 mm
Sensor diagonal dimension	21.1 mm
Pixel size	10.0 μm
A/D conversion	8 Bit
Dynamic	48 dB
Sensitivity	25 V/lux × s @ 525 nm
Trigger modes	internal free-run, switch, rising or falling edge, pre- and post-trigger
Power	12 VDC
Weight	1400 g without mount
Dimensions	150 mm x 92 mm x 92 mm
Housing	lightweight anodized aluminum
SSD bay	data storage and backup
PC software	TimeViewer for Windows (support for version 7, 8 and 10) for capture, video playback, export, export, image analysis with object tracking

Sprinter-HD Spectral Response (Quantum Efficiency Mono Sensor)

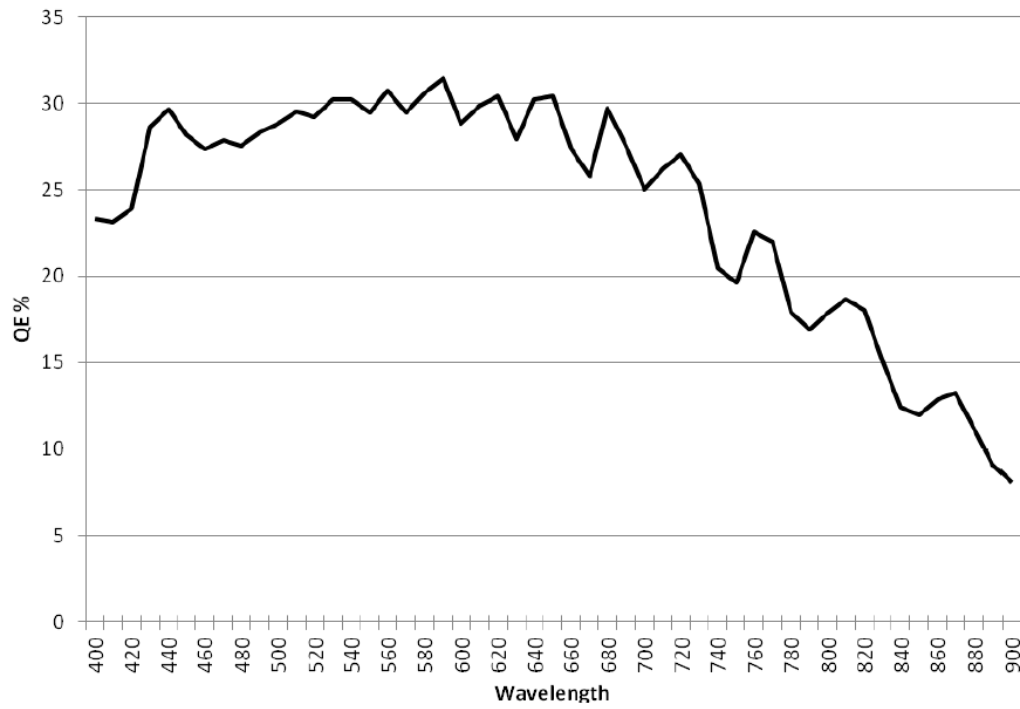

Figure 18: Spectral Response Curve

Performance (Examples)

Sprinter-FHD

Resolution (H x V)	Framerate (fps)	Recording Time (s)
1920 x 1080	1 908	4.6 s
1280 x 960	2 146	6.9 s
1280 x 720	2 859	6.9 s
640 x 480	4 283	13.8 s
384 x 288	7 119	23 s
256 x 128	15 880	35 s
256 x 8	206 451	35 s

Sprinter-HD

Resolution (H x V)	Framerate (fps)	Recording Time (s)
1280 x 860	3 504	4.4 s
1280 x 720	4 168	4.4 s
1280 x 4	128 514	25.78 s
640 x 480	6 168	9.0 s
384 x 240	11 862	15.7 s
256 x 192	14 548	24.0 s
256 x 4	128 514	122.8 s

Mechanical Dimensions

Sprinter Series (/FM, /FMG)

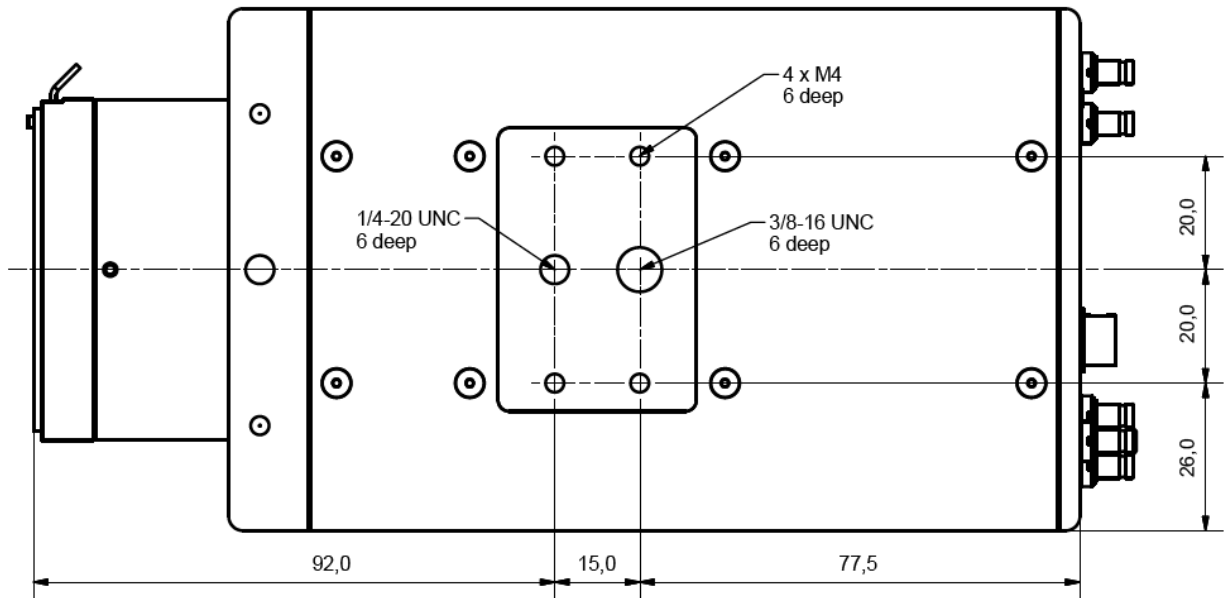

Figure 19: Bottom view

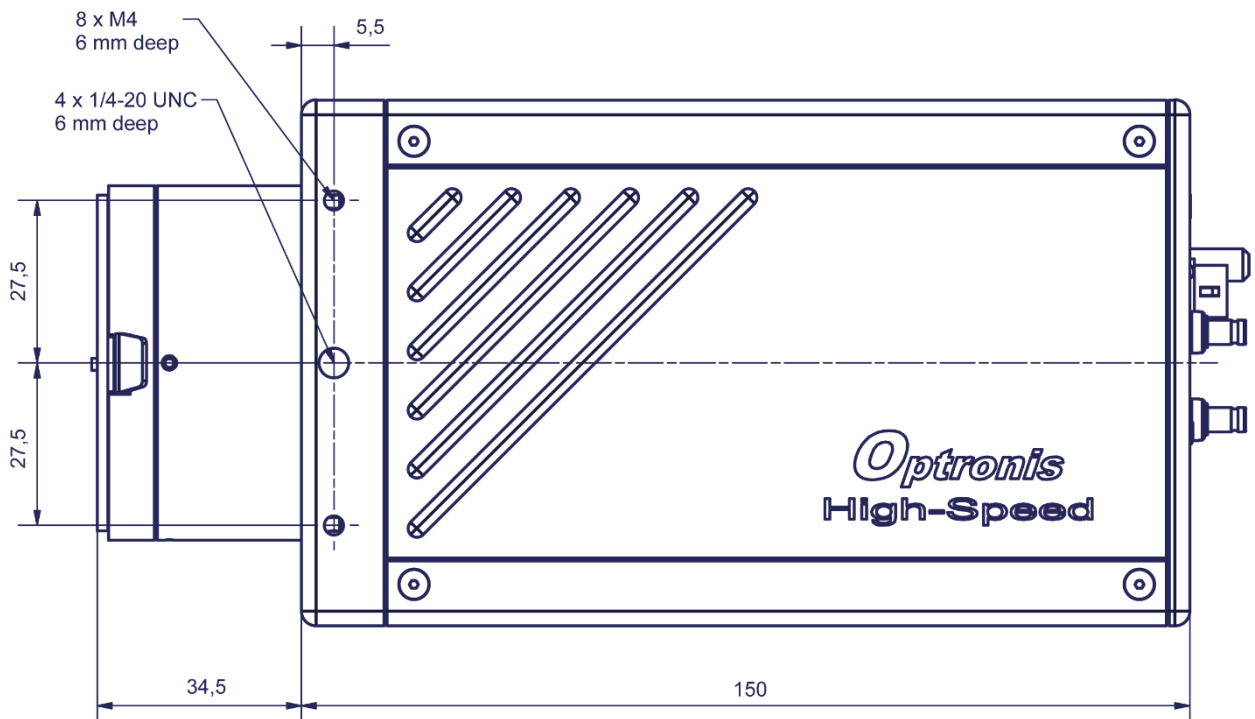

Figure 20: Side view

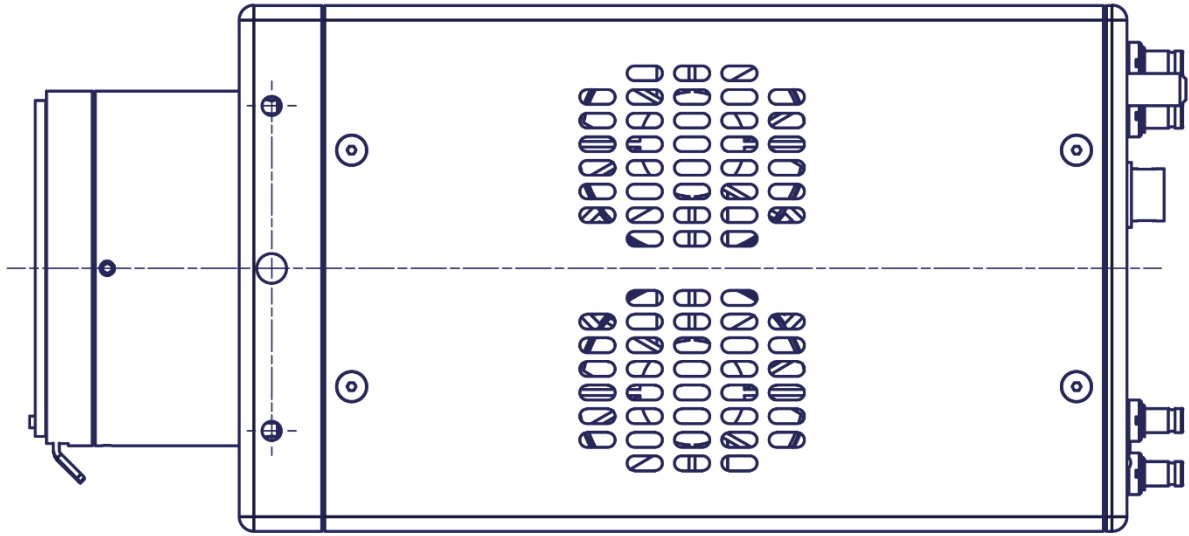

Figure 21: Top view

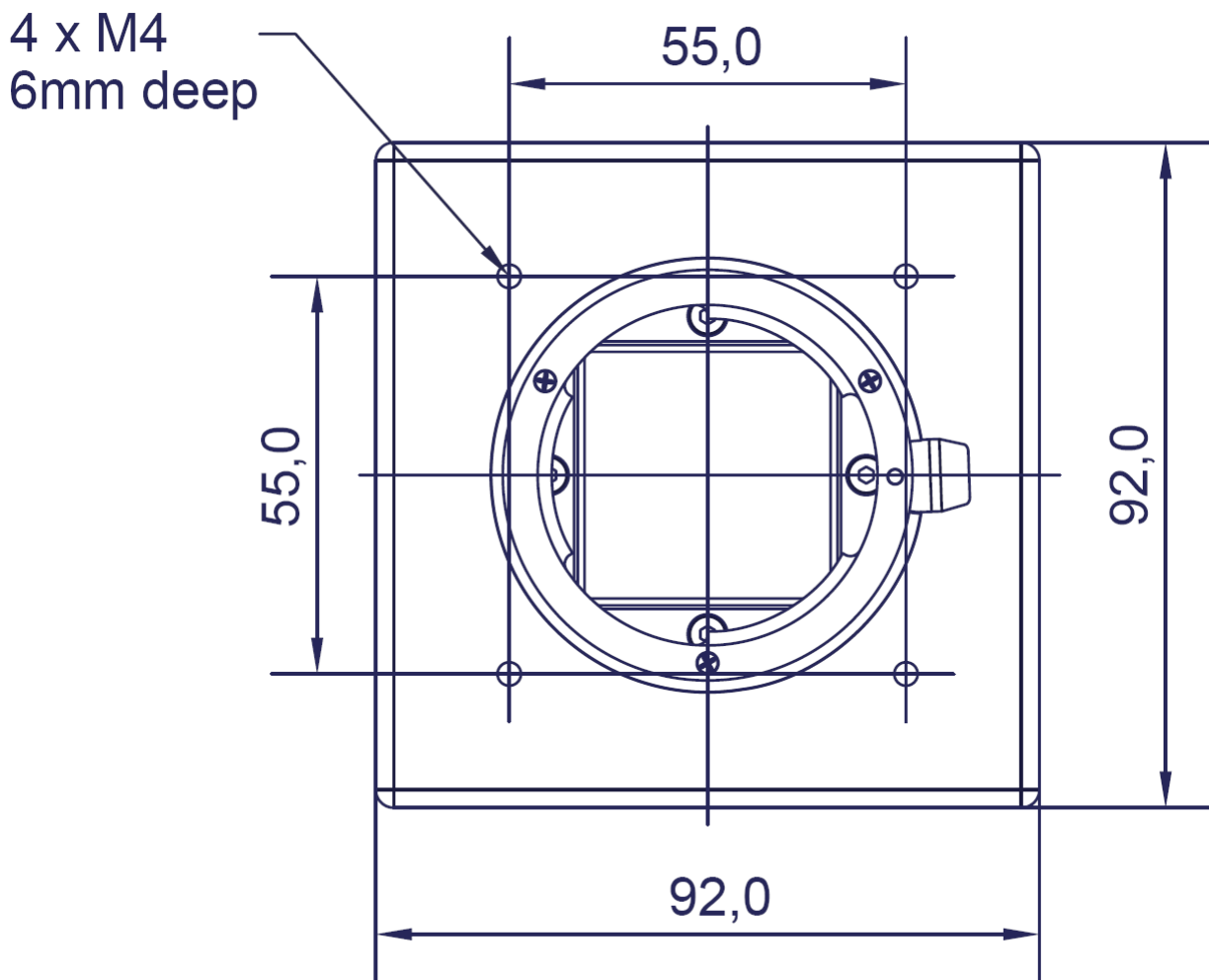

Figure 22: Front view

External Inputs

Trigger & Synchronization input

Level	- TTL Low Level: < 0,8Volt High Level: > 2 Volt - External Switch or Open Collator - Edge triggered
maximum Input Level:	+ 24 Volt / - 10 Volt
Edge	Rising: (TTL) Falling: (Trigger on external switch or Open Collector)
Rise-Time	< 100 nsec
Input Impedance	high (~ 800 Ohm)

Synchronization Timing

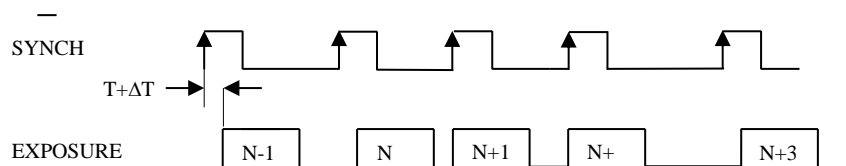

Figure 23: Input synchronization timing

All Sprinter models:

Delay (T): 3,27 μ sec

Jitter (ΔT): +/- 1,1 μ sec

Resulting delay (T+ ΔT): 2,17...4,37 μ sec

Trigger Timing

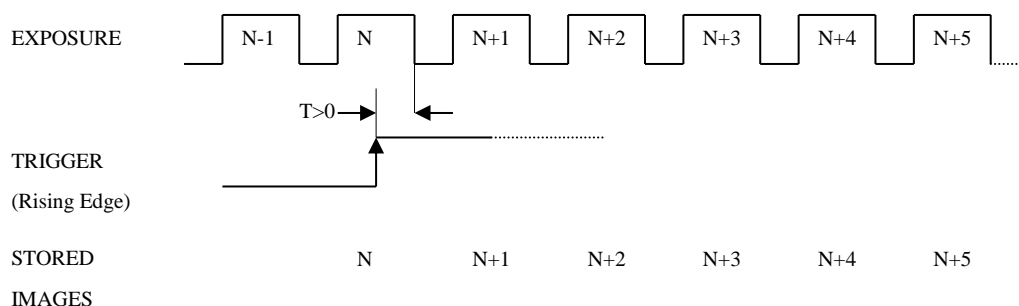

Figure 24: Trigger timing

External Outputs

Synchronization output

Level	TTL Low Level: < 0,8Volt High Level: 4 Volt typ. (into high Impedance) 2 Volt typ. (into 50 Ohm)
max. reverse Protection:	+ / - 10 Volt
Edge	Positive
Rise-Time	< 50 nsec

Synchronization Timing

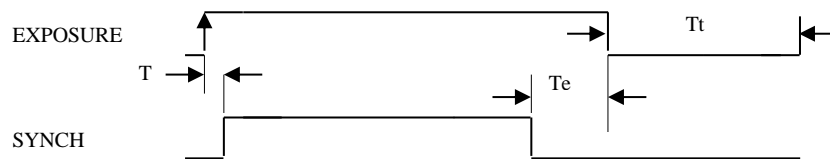

Figure 25: Output synchronization timing

All Sprinter models:

T : 100 nsec

Te: 100 nsec

Tt : min. 0

T : Delay between the beginning of the exposure and the beginning of Synchron Output

Te: Time-interval between end of synchron-signal and end of exposure-time

Tt : exposure dead time

Firmware Update

i

Please be careful when updating camera firmwares and follow below instructions.

Do not power off camera during a firmware update.

Check website product page and check download tab to get the latest camera firmwares.

<https://optronis.com/en/products/sprinter-fhd/>

<https://optronis.com/en/products/sprinter-hd/>

Alternatively, you can check TimeViewer installation folder “/Firmware/” and use its cr_server and .rbf files.

Why updating camera firmwares

When updating TimeViewer control software, a pop-up message (see below example) might indicate that a camera firmware update is required to get all features working properly.

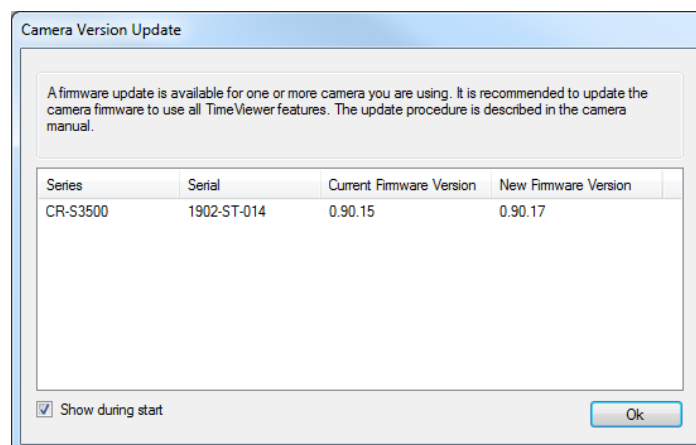

Figure 26: TimeViewer detects an out of date camera firmware

Alternatively, you might have received a newer firmware from Optronis support or by checking website product page.

How to update camera firmwares

Camera has 2 firmwares: 1 hardware (HW) and 1 software (SW).

To ensure compatibility, both firmwares must be updated at the same time. We also encourage you to get the last version of the control software (TimeViewer or Android application) when updating the camera.

Hardware firmware is an rbf file and is named "CR1900_version.rbf".

Software firmware has no extension and is named "cr_server_version".

To update camera firmwares please use an USB2 Stick formatted to FAT32 and use the Optronis tool CR1900_FlashTool:

Step 1: Copy new files on USB sticks

Start CR1900_FlashTool

Select HW and SW files and USB stick path (see Figure 27)

Click on copy button (see Figure 28)

Step 2: Program new Hardware firmware

Plug USB stick into camera and power cycle

Start CR1900_FlashTool

Set camera IP and when the camera network is established click on connect button (see Figure 29)

Click on "HW Firmware Update" button and wait (see Figure 30 and Figure 31). Update process takes ~8mn.

When Update is finished (see Figure 32), power cycle the camera. You can see update success by connecting again to the camera (click on "Disconnect" / "Connect" or restart software).

End. New version is now programmed (see Figure 33)

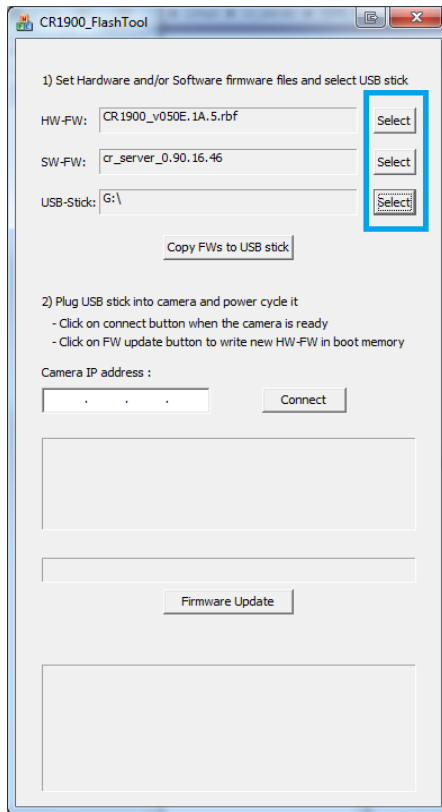

Figure 27: Select files and path

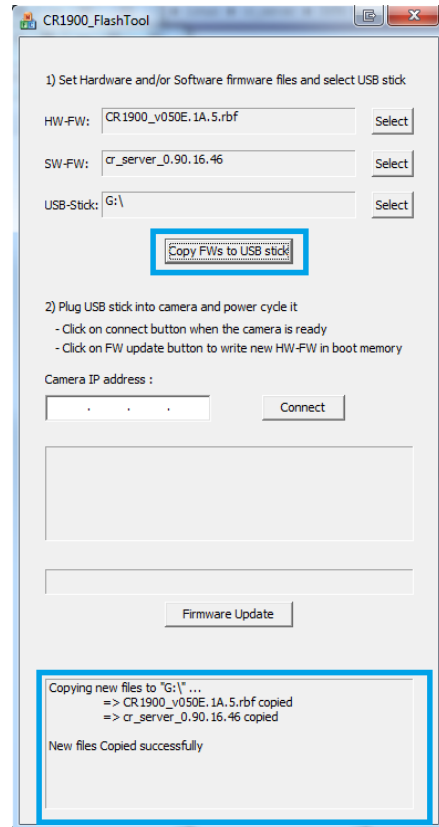

Figure 28: Copy files to USB stick

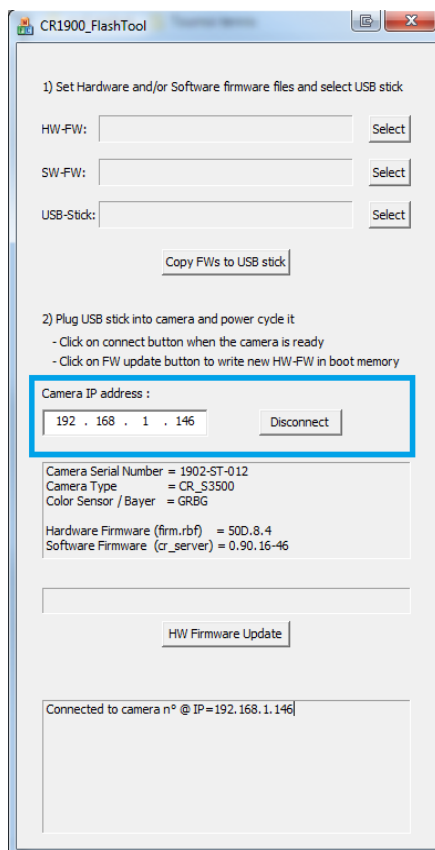

Figure 29: Connected to camera

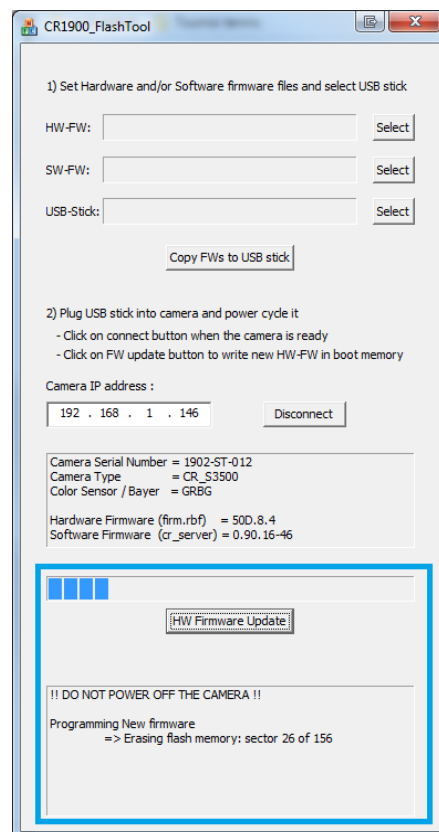

Figure 30: HW Update progressing 1/2

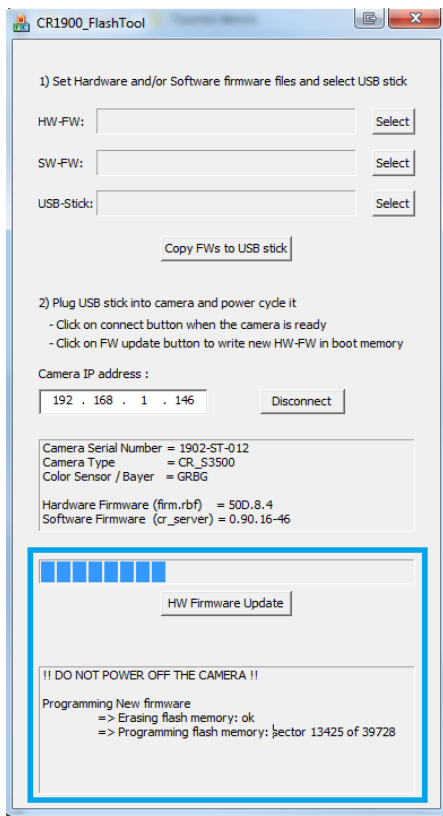

Figure 31: HW Update progressing 2/2

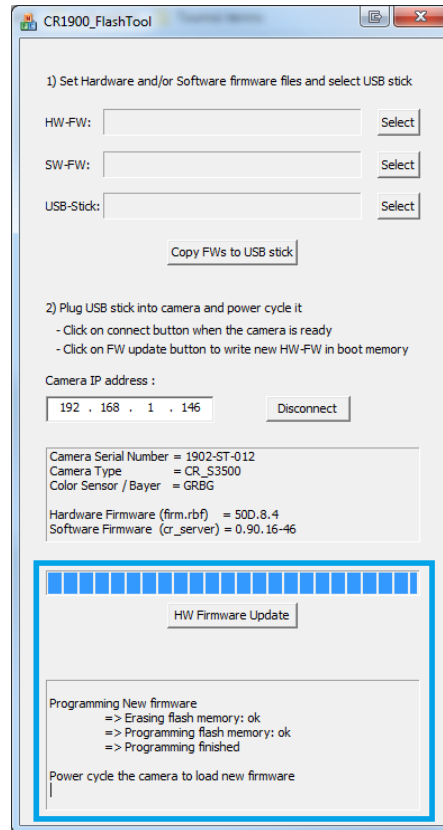

Figure 32: Update finished

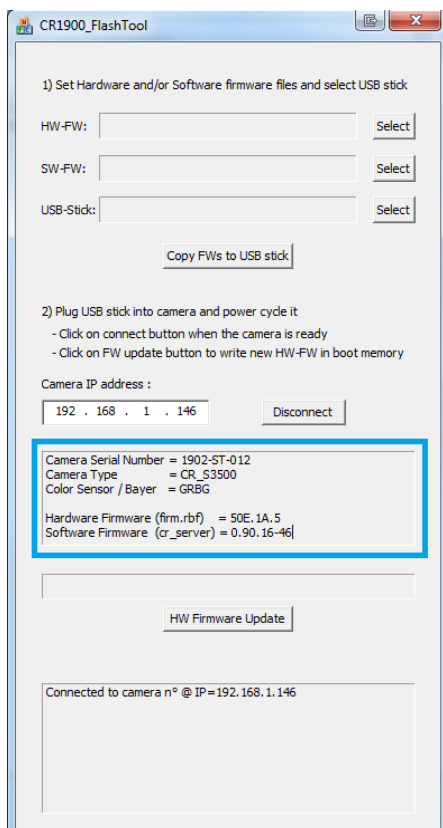

Figure 33: New HW is loaded at next power cycle