



See the possibilities

User Manual

SP-45001M-CXP2A

SP-45001C-CXP2A

*45M CMOS Digital Progressive Scan
Monochrome and color Camera
Document Version: 1.5
Feb.2024*

Thank you for purchasing this product.

 Be sure to read this manual before use.

This manual includes important safety precautions and instructions on how to operate the unit. Be sure to read this manual to ensure proper operation.

The contents of this manual are subject to change without notice for the purpose of improvement.

© 2024 JAI

Notice

The material contained in this manual consists of information that is proprietary to JAI Ltd., Japan and may only be used by the purchasers of the product. JAI Ltd., Japan makes no warranty for the use of its product and assumes no responsibility for any errors which may appear or for damages resulting from the use of the information contained herein. JAI Ltd., Japan reserves the right to make changes without notice. Company and product names mentioned in this manual are trademarks or registered trademarks of their respective owners.

Warranty

For information about the warranty, please contact your factory representative.

Certifications

CE compliance

As defined by the Directive 2004/108/EC of the European Parliament and of the Council, EMC (Electromagnetic compatibility), JAI Ltd., Japan declares that SP-45001M-CXP2A and SP-45001C-CXP2A complies with the following provisions applying to its standards.

EN 55032:2015(CISPR32:2015)

EN 55035:2017(CISPR35:2016)

FCC

This equipment has been tested and found to comply with the limits for a Class B digital device, pursuant to Part 15 of the FCC Rules. These limits are designed to provide reasonable protection against harmful interference in a residential installation. This equipment generates, uses and can radiate radio frequency energy and, if not installed and used in accordance with the instructions, may cause harmful interference to radio communications. However, there is no guarantee that interference will not occur in a particular installation. If this equipment does cause harmful interference to radio or television reception, which can be determined by turning the equipment off and on, the user is encouraged to try to correct the interference by one or more of the following measures:

- Reorient or relocate the receiving antenna.
- Increase the separation between the equipment and receiver.
- Connect the equipment into an outlet on a circuit different from that to which the receiver is connected.
- Consult the dealer or an experienced radio/TV technician for help.

Warning

Changes or modifications to this unit not expressly approved by the party responsible for FCC compliance could void the user's authority to operate the equipment.

KC



제조년월은 제품상자의 라벨을 참조하십시오.

Contents

Notice/Warranty/Certifications	2	Gamma Function	39
Usage Precautions	6	Lookup Table (LUT)	40
Features	7	Blemish Compensation	41
Parts Identifications	8	Shading Correction	42
		Binning Function	43
Preparation	14	ROI Function (Single ROI)	44
Preparation Process	14	ROI Function (Multi ROI)	45
Step 1:Connecting Devices	15	Overlay mode	46
Step 2:Verifying Camera Operation	16	Image flip function	47
Step 3:Verifying the Connection between the Camera and PC	16	Edge enhancer	48
Step 4:Adjusting the Image Quality	17	CXP Link Sharing function	49
Step 5:Saving the Settings	18	Event Control function	50
		Sequencer Function	51
		Pulse Generator	53
		Counter And Timer Control Function	54
		Lens control (Transfer camera control commands)	56
Main Functions	19		
CXP2.0 Supported Functions	19	Setting List	57
Acquisition Control	20	Feature Properties	58
Exposure Mode	21		
Trigger Control	22	Miscellaneous	69
Pixel Format	23	Troubleshooting	69
GPIO (Digital Input/Output Settings)	24	Specifications	70
Various Imaging Controls	26	Spectral Response	73
HDR (High Dynamic Range)	27	Dimensions	74
Frame Integration (Frame) mode	28	Comparison of the Decibel Display and Multiplier Display	77
Frame Integration (Exposure) mode	30	User's Record	78
Video Process Bypass Mode	31		
Timing chart	32	Index	79
Maximum Frame Rate Reference	34	Revision history	80
Calculate the maximum frame rate (approximate)	35		
Gain Control	36		
White Balance	37		
ALC (Automatic Level Control) Function	38		

■ Table of contents by function

DeviceControl	58							
ImageFormatControl	23	31	43	44	46	47	60	
AcquisitionControl	20	21	22	32	33	34	35	61
AnalogControl	17	36	37	39	64			
AutoLevelControl	38	65						
ImagingControl	26	27	28	29	30	60	65	
LUTControl	39	40	64					
DigitalIOControl	10	11	12	13	24	25	62	
CounterAndTimerControl	54	55	67					
UserSetControl	18	67						
SequencerControl	51	52	67					
TransportLayerControl	48	49	59					
PulseGenerator	53	53						
Shading	42	43	66					
BlemishControl	41	66						
MultiROIControl	45	60						
LensCommunicationControl	56	68						
EventControl	50	68						
HeatbeatControl	19							

■ About Technical Note

Some additional technical information is provided on the JAI website as Technical Notes. In this manual, if a technical note is available for a particular topic, the icon  Technical notes is shown.

Please refer to the following URL for Technical notes.

<https://www.jai.com/support-software/technical-notes>

Supplement

The following statement is related to the regulation on “Measures for the Administration of the control of Pollution by Electronic Information Products”, known as “China RoHS”. The table shows contained Hazardous Substances in this camera.

 mark shows that the environment-friendly use period of contained Hazardous Substances is 15 years.

重要注意事项

有毒，有害物质或元素名称及含量表

根据中华人民共和国信息产业部『电子信息产品污染控制管理办法』，本产品《有毒，有害物质或元素名称及含量表》如下。

部件名称	有毒有害物质或元素					
	铅 (Pb)	汞 (Hg)	镉 (Cd)	六价铬 (Cr (VI))	多溴联苯 (PPB)	多溴二苯醚 (PBDE)
棱镜	×	○	○	○	○	○
光学滤镜	×	○	×	○	○	○
连接插头	×	○	○	○	○	○
电路板	×	○	○	○	○	○
.....

○: 表示该有毒有害物质在该部件所有均质材料中的含量均在GB/T 26572-2011规定的限量要求以下。
 ×: 表示该有毒有害物质至少在该部件的某一均质材料中的含量超出GB/T 26572-2011规定的限量要求。
 (企业可在此处,根据实际情况对上表中打“×”的技术原因进行进一步说明。)



环保使用期限

电子信息产品中含有的有毒有害物质或元素在正常使用的条件下不会发生外泄或突变、电子信息产品用户使用该电子信息产品不会对环境造成严重污染或对基人身、财产造成严重损害的期限。

数字「15」为期限15年。

Usage Precautions

Notes on cable configurations

The presence of lighting equipment and television receivers nearby may result in video noise. In such cases, change the cable configurations or placement.

Notes on temperature conditions

The guaranteed operating temperature and humidity of this camera are -5°C to +45°C, 20% to 80% (non-condensing). Please make sure the following temperature condition is met when operating the unit.
1.) The camera's internal temperature sensor detects temperatures of 98.8°C or less during operation. If the above temperature conditions are exceeded, take measures to dissipate heat according to your installation environment and conditions.

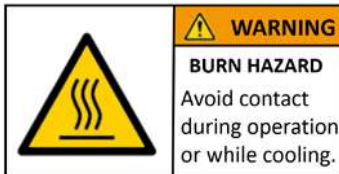

Depending on the operating environment, the surface of the camera may become very hot during operation. Do not touch the camera during operation and while it is being cooled. Also, make sure that the cable surface and other easily deformable items do not contact the surface of the camera.

Notes on attaching the lens

Avoiding dust particles

When attaching the lens to the camera, stray dust and other particles may adhere to the sensor surface and rear surface of the lens. Be careful of the following when attaching the lens.

- Work in a clean environment.
- Do not remove the caps from the camera and lens until immediately before you attach the lens.
- To prevent dust from adhering to surfaces, point the camera and lens downward and do not allow the lens surface to come into contact with your hands or other objects.
- Always use a blower brush to remove any dust that adheres. Never use your hands or cloth, blow with your mouth, or use other methods to remove dust.

 [Technical notes](#) How to clean a sensor

Phenomena specific to CMOS image sensors

The following phenomena are known to occur on cameras equipped with CMOS image sensors. These do not indicate malfunctions.

- Aliasing
When shooting straight lines, stripes, and similar patterns, vertical aliasing (zigzag distortion) may appear on the monitor.
- Blooming
When strong light enters the camera, some pixels on the CMOS image sensor may receive much more light than they are designed to hold, causing the accumulated signal charge to overflow into surrounding pixels. This "blooming" phenomenon can be seen in the image, but does not affect the operation of the camera.
- Fixed pattern noise
When shooting dark objects in high-temperature conditions, fixed pattern noise may occur throughout the entire video monitor screen.
- Defective pixels
Defective pixels (white and black pixels) of the CMOS image sensor are minimized at the factory according to shipping standards. However, as this phenomenon can be affected by the ambient temperature, camera settings (e.g., high sensitivity and long exposure), and other factors, be sure to operate within the camera's specified operating environment.

Notes on exportation

When exporting this product, please follow the export regulations of your country or region.

Features

SP-45001M-CXP2A/SP-45001C-CXP2A are new members of JAI's Spark Series, which provides an attractive combination of high resolution, high speed, and high image quality for machine vision applications.

SP-45001M-CXP2A produces monochrome output and SP-45001C-CXP2A produces Bayer output. Both are industrial progressive scan cameras using a CMOS image sensor with a global shutter and an optical format of Super 35mm.

Maximum frame rate is 38 fps for full resolution, 48 fps for 8K resolution via CoaXPress v2.0 (CXP12, Micro-BNC 2).

Feature overview

- Super 35mm (diagonal 31.5mm) 44.72 megapixel global shutter high resolution Bayer color CMOS image sensor or Monochrome CMOS image sensor.
- Effective pixels 8192(h) x 5460(v)
- Pixel size is 3.2 μ m x 3.2 μ m
- Various integrated functions
 - HDR(High Dynamic Range)
 - Frame Integration
- Supports video output modes : 8-bit, 10-bit, 12bit and 14-bit*.
 - (* 14-bit output is only available for some integrated functions)
- Interface : CoaXPress v2.0 (CXP12: 12.5Gbps, Micro-BNC 2)
- High-speed scanning (Maximum frame rate)
 - Full resolution(8192 x 5460) : 38 fps
 - 8K resolution (8192 x 4320) : 48 fps
- Can be connected to multiple PCs with the CXP Link Sharing function
- Lens control function (When using Birger Mount)
- Supports vertical dual-line binning, 2x horizontal binning, or both. (SP-45001M-CXP2A only)
- Supports flat shading and color shading(SP-45001C-CXP2A only).
- Built-in test signal for setting and adjustment.
- Excellent shock and vibration resistance.
- GenICam compliant.

Connection example

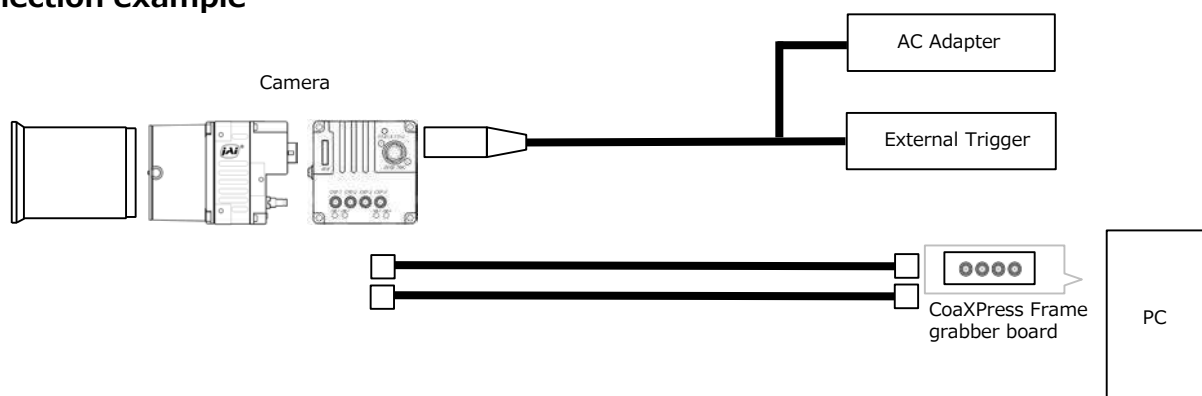

Parts Identification

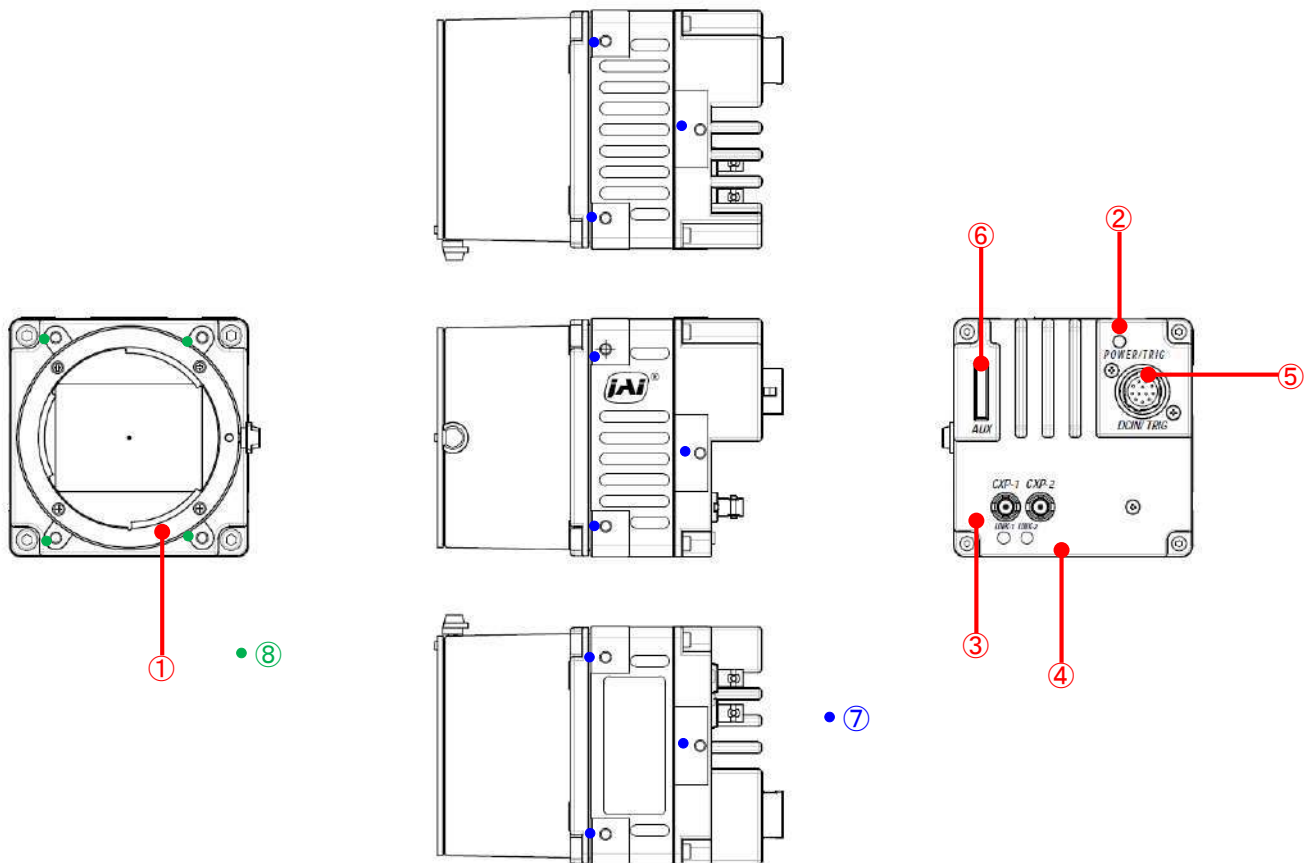

① Lens mount (F-mount)

Mount an F-mount lens, microscope adapter, etc. here.

❖ Before mounting a lens, be sure to refer to “Step 2:Connecting Devices” and confirm the precautions for attaching a lens and the supported lens types.

② POWER/TRIG LED

Indicates the power and trigger input status.

LED status and camera status

LED	Light	Status
POWER/ TRIG LED	● (Lit amber)	Camera initializing.
	● (Lit green)	Camera in operation.
	☀ (Blinking green)	During operation in trigger mode, trigger signals are being input. ❖ The blinking interval is not related to the actual input interval of the external trigger.

③ CXP (CoaXPress) connector 1~2

Coaxial cable for digital video output Connect.
(The camera connector (Amphenol RF 034-1028-12G equivalent) is used.)

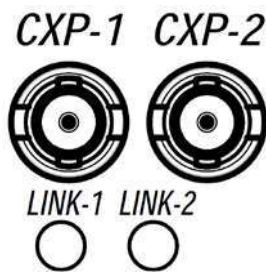

The CxpLink Configuration supported by this camera is as follows.

CXP12_X2*, CXP12_X1*
CXP6_X2, CXP6_X1

Caution

- *The CxpLink Configuration (CXP12_X2, CXP12_X1) can only be used with CXP 2.0. The CoaXPress frame grabber board used must support CXP 2.0. When using a CoaXPress frame grabber board that does not support CXP 2.0, set the CxpLinkConfiguration setting to CXP6_X2 or CXP6_X1.
- You can check the current CXP version in [CxpVersion Used] of [Transport Layer Control]. If [CxpVersionUsed] is CXP 1.1, you cannot use the CXP12 link configurations. Even if you are using a CoaXPress frame grabber board that supports CXP 2.0, if [CxpVersionUsed] is CXP 1.1, you may need to make settings on the frame grabber board side. For the specific setting method, refer to the instruction manual of the frame grabber board to be used.
- The CxpLinkConfiguration setting must match the number of CoaXPress cables that connect the camera to the PC. For example, if it is CXP12_X2, connect all two. If the number of connection cables is less than the setting, reset the CxpLink Configuration setting according to the number of connection cables.

④ LINK LED 1~2

Indicates the connection status of the CoaXPress.

LED	Light	Status
LINK	Off	Power is off.
	(Blinking amber (rapid))	Detecting link ❖ Blinks for 1 second even when detected immediately.
	(Blinking amber (slow))	Waiting for connection between device and host to be established or for event (trigger, exposure pulse, etc.) to occur.
	(Alternating between green and amber (slow))	Sending connection test packet.
	(Lit green)	Connection between device and host is established, but there is no data being transmitted.
	(Lit red interval 500ms)	An error occurred during data transmission (CRC error, single bit error, etc. detected). ❖ Lights for at least 200 ms before errors are displayed when multiple errors occur simultaneously.
	(Blinking green (rapid))	Connection between device and host is established, and data is being transmitted.
	(Red pulse (slow))	No connection.

⑤ DC IN/TRIG connector (12-pin round)

Connect the cable for a power supply (optional) or for DC IN / trigger IN here.

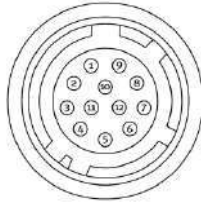

Compatible connectors

Camera side : HR10A-10R-12PB (71) (Hirose Electric or equivalent)

Cable side : HR10A-10P-12S (plug) (Hirose Electric or equivalent)

Pin No.	Input/Output	Signal	Description
1	GND	GND	
2	Power In	DC In	DC 10 V ~ 25 V
3	GND	GND	
4		NC	
5	In	Opto In 1-	Line 5
6	In	Opto In 1+	
7	Out	Opto Out 1-	Line 2
8	Out	Opto Out 1+	
9	Out	TTL Out 1	Line 1
10	In	TTL In 1	Line 4
11	Power In	DC In	DC 10 V ~ 25 V
12		GND	

Note

A Power is supplied to this camera from DC IN/TRIG connector or PoCXP.
Be sure to use a power supply that can support the maximum power consumption of this camera.

- CXP-1 is the only channel for PoCXP.

TTL signal specification

TTL out signal specification (Typ.)

Output voltage : Low 0.0V
 High 5.0V

TTL in signal specification (Typ.)

Input voltage : Low 0.0~0.8V
 High 2.0~5.5V

■ Recommended external input circuit diagram (reference example)

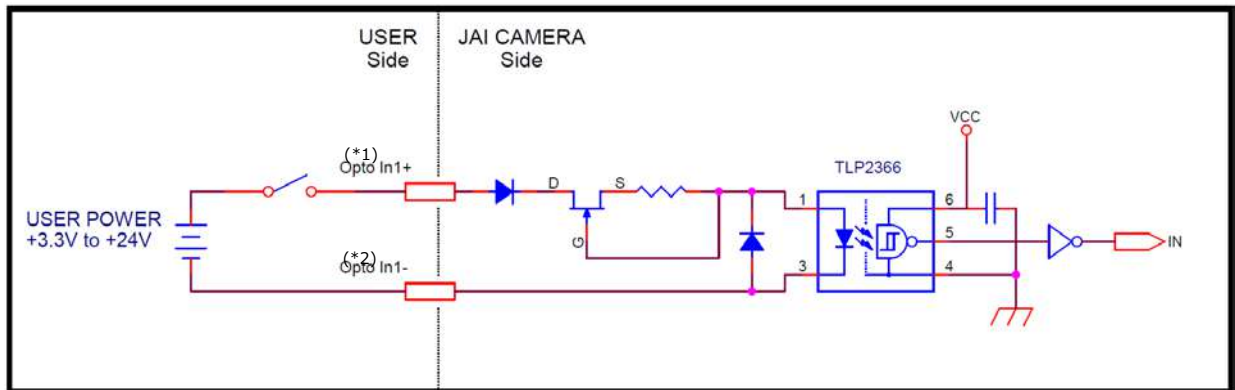

Opto In 1 :
 (*1) Pin6 (Opto In 1+)
 (*2) Pin5 (Opto In 1-)

■ Recommended external output circuit diagram (reference example)

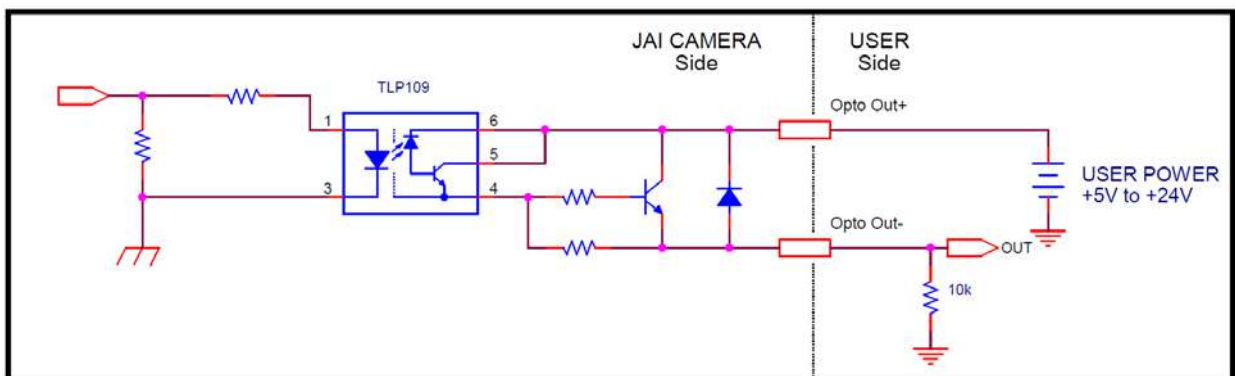

 Technical notes OPTO-In circuit characteristics

■ Characteristics of the recommended circuits for Opto OUT

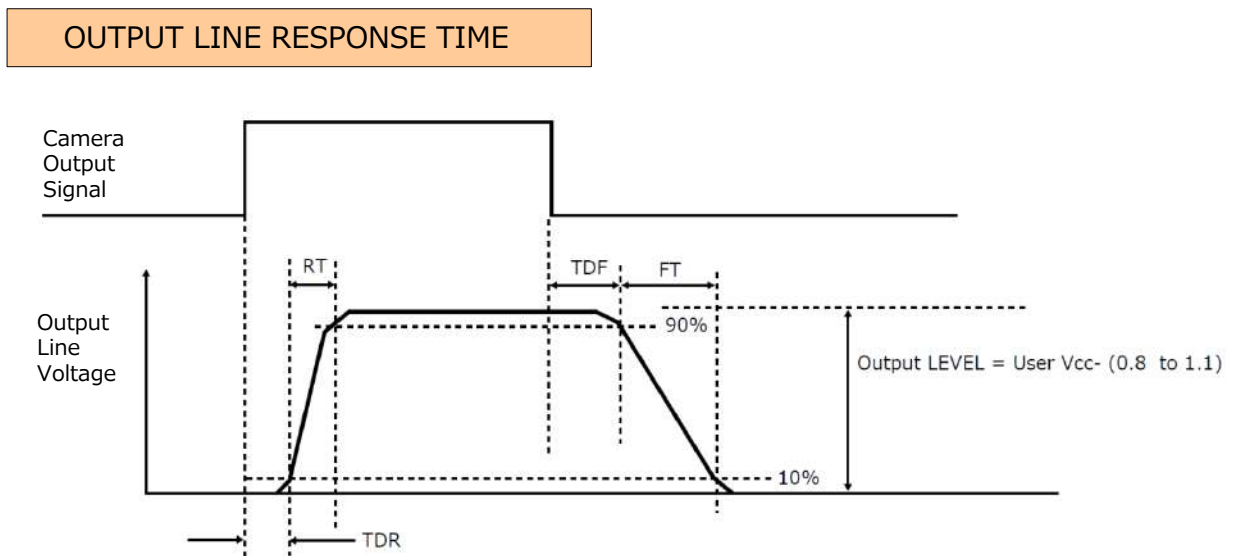

For the operating conditions of applied voltage (User Power) +12V, load resistance 10k Ω , and cable length 1m, the timing is shown in the table below.

Item	Result (Typ)
TDR(Time Delay Rise) (μ S)	0.48
RT(Risc Time) (μ S)	3.08
TDF(Time Delay Fall) (μ S)	3.16
FT(Fall Time) (μ S)	52.4

*) Since it varies depending on the applied voltage, load resistance, cable length, etc., check the actual environment before use.

Caution

Please note that the recommended load resistance of Opto output is 10 k Ω (rated 1/10 W) or more. The 270 Ω resistor shown in the circuit diagram is the MINIMUM resistance that should be used. The response speed from On (High) to Off (Low) depends on the voltage applied to Opto output and the value of the load resistance. Higher load resistance results in slower response. If the response at 10 k Ω is slower than desired, you can try reducing the load resistance in order to increase the response speed but DO NOT go below the minimum 270 Ω value.

The load resistance loss can be calculated as follows.
 load resistance loss \doteq (voltage applied to Opto output)² / (load resistance)

⑥ AUX connector (10-pin)

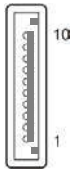

Camera side : 3260-10S3 (55) (Hirose Electric or equivalent)
 Cable side : 3240-10P-C (50) (Hirose Electric or equivalent)

Pin No.	Input/Output	Signal	Description
1	Out	TTL Out 2	Line 8
2		N.C.	
3	In	TTL In 2	Line 10
4		N.C.	
5	GND	GND	
6	DC Out	LENS Power	DC9V
7	Out	RS232C-Tx	For lens control
8	Input	RS232C-Rx	
9	GND	GND	
10	GND	GND	

⑦ Camera locking screw holes (M3, 5 mm depth)

Use these holes when attaching an MP-42 tripod adapter plate (optional) or mounting the camera directly to a wall or other structural system.

⑧ Camera locking screw holes (M3, 3 mm depth)

Use these holes when mounting the camera directly to a wall or other structural system.

Preparation

Preparation Process

- | | |
|---------------|---|
| Step 1 | Connecting Devices
Connect the lens, CXP frame grabber, AC adapter, computer and other devices. |
| ↓ | |
| Step 2 | Verifying Camera Operation
Verify whether the camera is turned on and ready for use. |
| ↓ | |
| Step 3 | Verifying the Connection between the Camera and PC
Set settings and display image using suitable tool for CXP frame grabber board. |
| ↓ | |
| Step 4 | Adjusting the Image Quality
Refer to the procedures for adjusting the gain, white balance, and black level as examples, and adjust the image quality. |
| ↓ | |
| Step 5 | Saving the Settings
Save the current setting configurations in user memory. |

Step 1: Connecting Devices

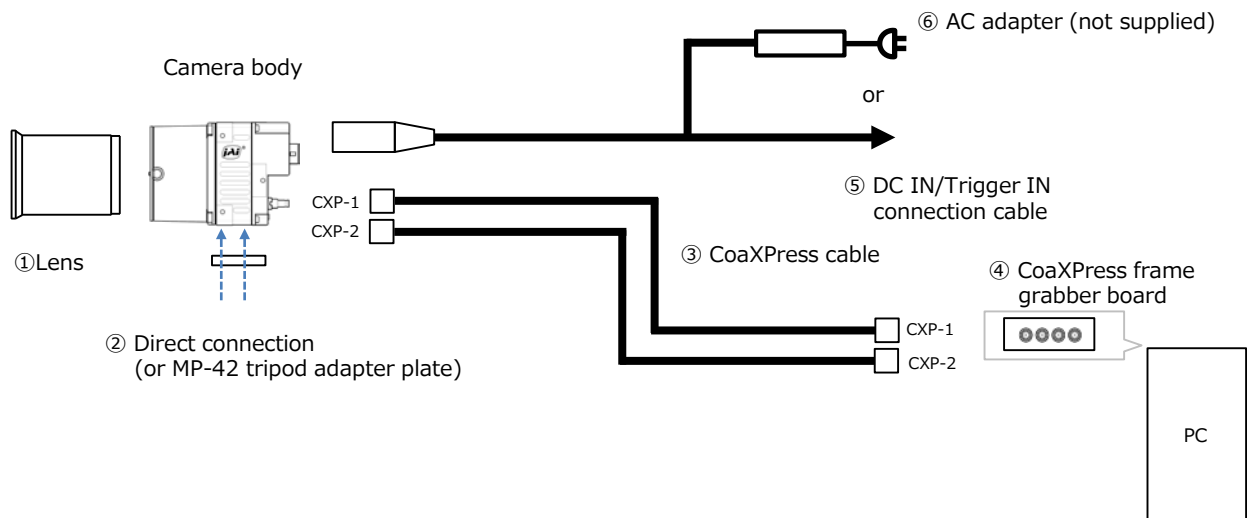

① Lens

Attach a F-mount lens.

The diagonal of the camera's CMOS image sensor of this camera is 31.5 mm, the size of standard Super 35mm lenses. To prevent vignetting and to obtain the optimal resolution, use a lens that will cover the 31.5 mm diagonal. Some lens manufacturers offer lenses with a 31.5 mm format. If not, a Super 35mm lens is recommended.

Note

The following formula can be used to estimate the focal length.

$$\text{Focal length} = \text{WD} / (1 + \text{W}/\text{w})$$

WD : Working distance (distance between lens and object)

W : Width of object

w : Width of sensor (26.21 mm on this camera)

[Technical notes](#) Lens Selection Guide

② Direct connection (or MP-42 tripod adapter plate)

When mounting the camera directly to a wall or other device, use screws that match the camera locking screw holes on the camera (M3, depth: 5 mm). Use the supplied screws to attach the tripod adapter plate.

Caution

For heavy lenses, be sure to support the lens itself. Do not use configurations in which its weight is supported by the camera.

③ CXP cable

Connect the CXP cable to the CXP connector on the camera and frame grabber board.

- The number of cables to connect depends on the number of connectors (1, 2 or 4) on the frame grabber board.
- Connect each cable to the connector number corresponding to the camera and frame grabber board.
- Refer to the specifications of the cable for details on its bend radius.

④ CXP frame grabber board

Refer to the operating instructions of the frame grabber board, and configure settings on the computer as necessary.

⑤ DC IN / trigger IN connection cable

⑥ AC adapter (power supply)

Connect the AC adapter and the round connector of the connection cable to the DC IN / TRIG IN connector on the camera.

Step 2: Verifying Camera Operation

When power is supplied to the camera while the necessary equipment is connected, the POWER/TRIG LED at the rear of the camera lights amber, and initialization of the camera starts. When initialization is complete, the POWER/TRIG LED lights green.

Verify whether power is being supplied to the camera by checking the rear LED.

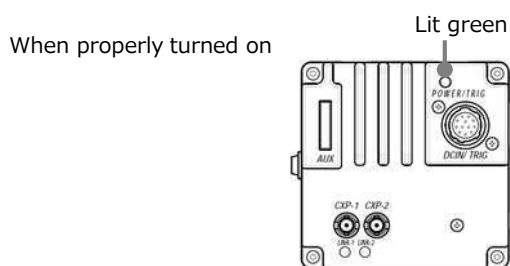

- For details on how to read the LEDs, see “LED status and camera status” in the “Parts Identification” section.
- Initialization of the camera is not complete until connection with the host is established. If the power / trigger LED does not switch to green within minutes of supplying power, check the CXP cable and other connections. After initialization is completed once, the power / trigger LED will remain green, even if the host is disconnected.

Step 3: Verifying the Connection between the Camera and PC

Use the appropriate tool for the CoaXPress frame grabber board to be used to set up the camera and display captured images. Refer to the operation manual of the tool to be used for the operation method.

Step 4: Adjusting the Image Quality

Adjusting the Gain

To adjust the image quality

The Visibility must be changed from [Beginner] to [Guru]. At first, adjust the sensitivity via the analog base gain. Next, set digital gain. For details on gain control, see "Gain Control" in the "Main Functions" section.

■ Manual adjustment

- 1 Expand [AnalogControl], and set [AnalogBaseGain].**
(It can be set in 0dB, 6dB or 12dB.)
- 2 Expand [AnalogControl] and set [GainAuto] to [Off] and configure the gain.**
 - ①** Expand [AnalogControl], and select the gain you want to configure in [GainSelector]. [DigitalAll] (master gain), [DigitalRed]* (digital R gain), and [DigitalBlue]* (digital B gain) can be configured.
 - ②** Configure the gain value in [Gain].
 - [DigitalAll] (master gain) can be set to a value from x1 to x16 the analog gain value. The resolution is set in about 0.1dB steps. Values are configured by multipliers.
 - The [DigitalRed]* (digital R gain) and [DigitalBlue]* (digital B gain) can be set to a value from x0.447 to the [ADigitalAll] (master gain) value. The resolution is set in 0.000122 steps. Values are configured by multipliers.

Adjusting the White Balance (SP-45001C-CXP2A only)

Adjust the white balance using the automatic adjustment function.

■ Automatic white balance adjustment

- 1 Place a white sheet of paper or similar object under the same lighting conditions as the intended subject, and zoom in to capture the white.**
White objects near the subject, such as a white cloth or wall, can also be used. Be sure to prevent the high-intensity spot lights from entering the screen.
- 2 Select the [BalanceWhiteAuto] tab, and select [Continuous] or [Once] for the adjustment method.**
The white balance is automatically adjusted.

Note

[Continuous] and [Once] adjust the white balance by gain adjustment.

Adjusting the Black Level

- 1 Expand [AnalogControl], and select the black level you want to configure in [BlackLevelSelector].**
[All] (master black), [Red]* (digital R), and [Blue]* (digital B) can be configured.
- 2 Specify the adjustment value in [BlackLevel].**

*) SP-45001C-CXP2A Only

Step 5: Saving the Settings

The setting values configured in the tool will be deleted when the camera is turned off. By saving current setting values to user memory, you can load and recall them whenever necessary. You can save up to three sets of user settings in the camera. (User Set1 to 3)

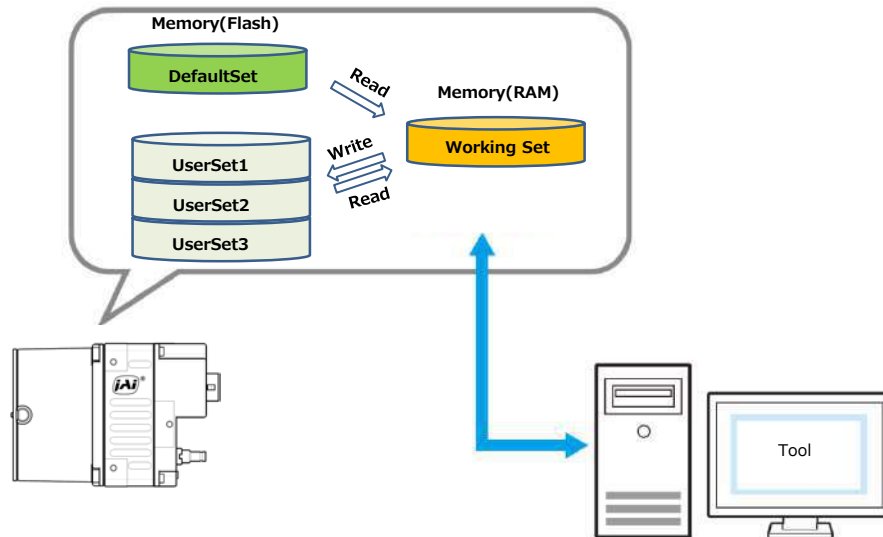

■ To save user settings

- 1** Stop image acquisition.
- 2** Expand [UserSetControl], and select the save destination ([UserSet1] to [UserSet3]) in [UserSetSelector].

Note

The factory default setting values are stored in [Default] and cannot be overwritten.

Caution

Settings can only be saved when image acquisition on the camera is stopped.

- 3** Select [UserSetSave], and click [Execute 'UserSetSave' Command].

The current setting values are saved as user settings.

■ To load user settings

- 1** Stop image acquisition.
User settings can only be loaded when image capture on the camera is stopped.
- 2** Select the settings to load (UserSet1 to UserSet3) in [UserSetSelector].
- 3** Select [UserSetLoad], and click [Execute 'UserSetLoad' Command].

The selected user settings are loaded.

Main Functions

CXP2.0 Supported Functions

This camera supports the following CXP2.0 functions (the CoaXPress frame grabber board used must support CXP 2.0 or later).

You can check the current CXP version in Transport Layer Control's CxpVersionUsed. If CxpVersionUsed is CXP1.1, you cannot use these functions.

■ CXP Link Sharing Function

This function allows a camera to connect to multiple PCs. For more information, see the CXP Link Sharing topic.

■ Event Control Function

This function outputs a signal change point inside the camera as information indicative of an event occurrence (event message). For more information, see the Event Control topic.

■ Heartbeat Function

The camera periodically sends signals to the PC to verify that the connection is valid.

- When connected to a CXP 2.0 compatible FG board and the CxpVersionUsed register is set to 2.0, the Heartbeat function is forcibly turned on (you cannot switch the function On/Off).
- Heartbeat packets are issued from the device (camera) to the host (PC).
- The interval time for Heartbeat output is fixed at 10ms.

Note

The Heartbeat function does not appear in the Setting List because there are no customer-configurable items.

Acquisition Control

This camera has three Acquisition modes (SingleFrame, MultiFrame, Continuous). Use [AcquisitionControl] settings to perform operations and settings for image capture.

SingleFrame

When the [AcquisitionStart] command is executed, one frame of image is captured.



MultiFrame

When the [AcquisitionStart] command is executed, the number of frames set in [AcquisitionFrameCount] are acquired as images.

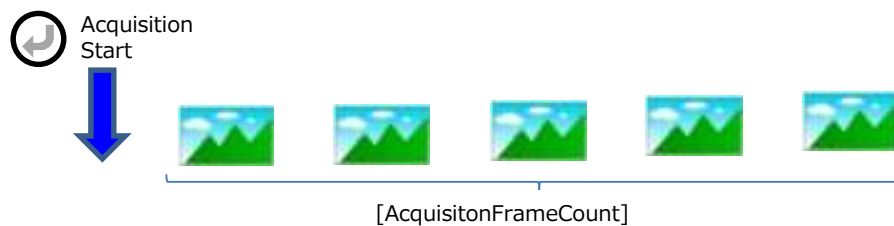

Continuous

When the [AcquisitionStart] command is executed, images will continue to be acquired until the [AcquisitionStop] command is executed.



Changing the Frame Rate

When [TriggerMode] is disabled, you can change the frame rate in [AcquisitionFrameRate].

Note

- The shortest frame period varies depending on the ROI, pixel format, and binning mode selected. The longest frame period is 0.125 Hz (8 sec.).
- When TriggerMode[FrameStart] is enabled, the [AcquisitionFrameRate] setting is disabled.

Exposure Mode

This camera has three Exposure modes (Off, Timed, TriggerWidth).
Use [AcquisitionControl] settings to perform operations and settings for exposure.

ExposureMode = Off

Exposure control is not performed (free-running operation).
The exposure time is the longest possible time within the operating conditions such as the frame rate.

ExposureMode = Timed

Mode in which control is performed using exposure time. Acquire images using an exposure time configured beforehand on an external trigger.
In this mode, the exposure time can be adjusted automatically by setting [ExposureAuto]. For details, refer to "ALC (Automatic Brightness Control) Function".

ExposureMode = TriggerWidth

Mode in which control of the exposure time is performed using the pulse width of the trigger input signal. The exposure time will be the same as the pulse width of the trigger input signal.

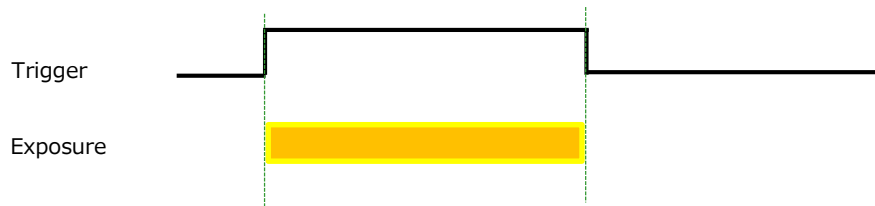

- The settings for exposure control and triggers are related to each other. Be sure to configure the settings described in "Trigger Control".

Actual Exposure Times

The minimum exposure time that can be set for each operation mode and CXP mode is as follows.

Operation mode	CXP12-2	CXP6-2
Normal	90 μ s	90 μ s
HDR(Linear)	90 μ s	90 μ s
HDR(Knee)	90 μ s	90 μ s
FrameIntegration(Exposure)	210 μ s	210 μ s
FrameIntegration(Frame)	210 μ s	210 μ s

The actual exposure time will be shorter than the time set for this camera.

- Operation mode is Normal or FrameIntegration(Exposure, Frame)
 - PixelFormat : Mono8 or Bayer8
The actual exposure time is obtained by subtracting 9.6 μ s from the set time.
 - PixelFormat : Mono10 or Mono12 or Mono14 or Bayer 10 or Bayer12 or Bayer14
The actual exposure time is obtained by subtracting 8.2 μ s from the set time.
- Operation Mode is HDR(Linear, Knee)
 - The actual exposure time is obtained by subtracting 15.8 μ s from the set time.

Trigger Control

The camera allows the following controls to be performed via external trigger signals.

TriggerSelector	Description
AcquisitionStart	Start image acquisition in response to the external trigger signal input.
AcquisitionEnd	Stop image acquisition in response to the external trigger signal input.
FrameStart	Start exposure in response to the external trigger signal input. Select this to perform exposure control using external triggers.

- The settings for exposure control and triggers are related to each other. Be sure to configure the settings described in "ExposureMode" .
- You can delay when exposure actually starts after a trigger is received by a specific amount of time by configuring [TriggerDelay].

Select the trigger type with TriggerSelector, and set the following items for each trigger.

[TriggerMode] Switch enable or disable.

[TriggerSource] Select the source signal.

PulseGenerator0, PulseGenerator1, PulseGenerator2, PulseGenerator3,
UserOutput0, UserOutput1, UserOutput2, UserOutput3,
Software*,
Line4, Line5, Line7, Line10,
Nand0Out, Nand1Out

* Trigger can be executed by TriggerSoftware [TriggerSelector] command only when Software is set.

[TriggerActivation] Sets the polarity of the trigger signal.

[TriggerDelay] You can specify a delay after receiving the trigger signal until the trigger is enabled.

When using FrameStart trigger

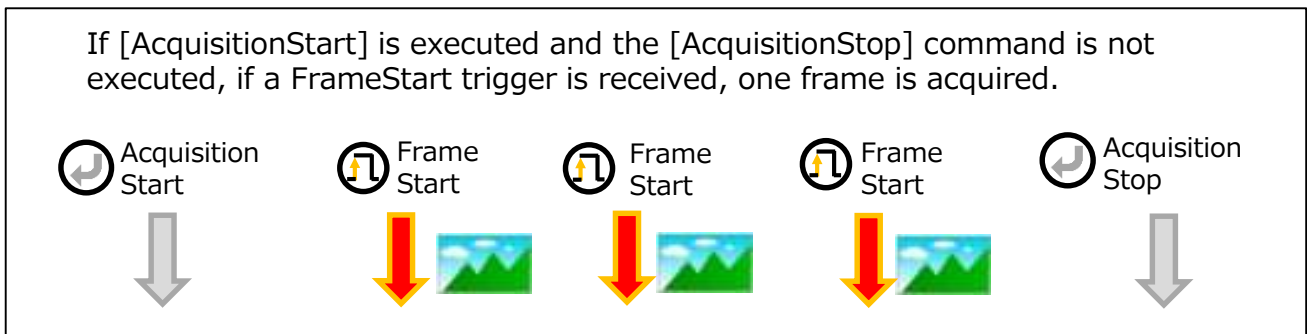

The source signals that can be set for the trigger are as follows.

	Off	AcquisitionActive	FrameActive	ExposureActive	FVAL	LVAL	Software	PulseGenerator0	PulseGenerator1	PulseGenerator2	PulseGenerator3	UserOutput0	UserOutput1	UserOutput2	UserOutput3	Line4	Line5	Line7	Line10	Nand0Out	Nand1Out	Low	High	AcquisitionTriggerWait	FrameTriggerWait
AcquisitionStart							✓	✓	✓	✓	✓	✓	✓	✓	✓	✓	✓	✓	✓	✓	✓				
AcquisitionEnd							✓	✓	✓	✓	✓	✓	✓	✓	✓	✓	✓	✓	✓	✓	✓				
FrameStart							✓	✓	✓	✓	✓	✓	✓	✓	✓	✓	✓	✓	✓	✓	✓				

Pixel Format

Selectable PixelFormat is as follows.

SP-45001C-CXP2A : BayerRG8, BayerRG10, BayerRG12, BayerRG14

SP-45001M-CXP2A : Mono8, Mono10, Mono12, Mono14

Note

- In SP-45001C-CXP2A, the Bayer array is changed by the image flip function.
(Please refer to "Image flip function")
 - ReverseX : 0 (False) ReverseY : 0 (False) -> BayerRG
 - ReverseX : 0 (False) ReverseY : 1 (True) -> BayerGB
 - ReverseX : 1 (True) ReverseY : 0 (False) -> BayerGR
 - ReverseX : 1 (True) ReverseY : 1 (True)-> BayerBG
- 14bit output is available only in HDR(Linear) mode and FrameIntegration (Exposure) mode.

Caution

When using 12bit PixelFormat in normal operation mode, Histogram values may be missing. In this case, please using VideoProcessBypass mode.

GPIO (Digital Input/Output Settings)

The unit can input/output the following signals to and from external input/output connectors.

External output	Line1 : TTL Out 1	DC IN / TRIG IN connector (12-pin round)
	Line2 : Opt Out 1	DC IN / TRIG IN connector (12-pin round)
	Line8 : TTL Out 2	AUX connector (10-pin)
External input	Line4 : TTL In 1	DC IN / TRIG IN connector (12-pin round)
	Line5 : Opt In 1	DC IN / TRIG IN connector (12-pin round)
	Line10 : TTL In 2	AUX connector (10-pin)
For Lens Control	RS232C (Tx/Rx)	AUX connector (10-pin)

These signals can be used as triggers and other necessary signals within the camera or as signals output from the camera to the system, such as those used for lighting equipment control.

*) For details on the RS232C (Tx / Rx) for lens control, refer to "Lens Control".

Use the [Digital I/O Control] to set the digital input / output.

Select input or output in [LineSelector], you can check [LineMode], [LineFormat] and set [LineInverter].

You can also check the status of each digital I/O as shown in the table below with [LineStatusAll].

	LineMode	LineFormat	LineInverter	LineStatusAll	
Line1	Output	TTL	True/False	bit0	DC IN / TRIG IN connector (12-pin round)
Line2	Output	OptoCoupled	True/False	bit1	DC IN / TRIG IN connector (12-pin round)
Line4	Input	TTL	False (fixed)	bit3	DC IN / TRIG IN connector (12-pin round)
Line5	Input	OptoCoupled	False (fixed)	bit4	DC IN / TRIG IN connector (12-pin round)
Line7	Input	InternalSignal	False (fixed)	bit6	CXP In
Line8	Output	TTL	True/False	bit7	AUX connector (10-pin)
Line10	Input	TTL	False (fixed)	bit9	AUX connector (10-pin)
Nand0In1	Input	InternalSignal	True/False		
Nand0In2	Input	InternalSignal	True/False		
Nand1In1	Input	InternalSignal	True/False		
Nand1In2	Input	InternalSignal	True/False		
TimestampReset	Internal Connection	InternalSignal	False (fixed)		

For digital output, set the output source signal using [LineSource].
 Set the source signal in the same way for NAND Logic (Nand0In1, Nand0In2, Nand1In1, Nand1In2) and TimestampReset.
 The table below shows the source signals that can be set.

	FrameTriggerWait	AcquisitionTriggerWait	High	Low	Nand1Out	Nand0Out	Line10	Line7	Line5	Line4	UserOutput3	UserOutput2	UserOutput1	UserOutput0	PulseGenerator3	PulseGenerator2	PulseGenerator1	PulseGenerator0	LVAL	FVAL	ExposureActive	FrameActive	AcquisitionActive	Off
Line1	✓	✓	✓	✓	✓	✓	✓	✓	✓	✓	✓	✓	✓	✓	✓	✓	✓	✓	✓	✓	✓	✓	✓	✓
Line2	✓	✓	✓	✓	✓	✓	✓	✓	✓	✓	✓	✓	✓	✓	✓	✓	✓	✓	✓	✓	✓	✓	✓	✓
Line4																								
Line5																								
Line7																								
Line8	✓	✓	✓	✓	✓	✓	✓	✓	✓	✓	✓	✓	✓	✓	✓	✓	✓	✓	✓	✓	✓	✓	✓	✓
Line10																								
Nand0In1		✓	✓	✓	✓		✓	✓	✓	✓	✓	✓	✓	✓	✓	✓	✓	✓	✓	✓	✓	✓	✓	✓
Nand0In2		✓	✓	✓	✓	✓	✓	✓	✓	✓	✓	✓	✓	✓	✓	✓	✓	✓	✓	✓	✓	✓	✓	✓
Nand1In1		✓	✓	✓	✓	✓	✓	✓	✓	✓	✓	✓	✓	✓	✓	✓	✓	✓	✓	✓	✓	✓	✓	✓
Nand1In2		✓	✓	✓	✓	✓	✓	✓	✓	✓	✓	✓	✓	✓	✓	✓	✓	✓	✓	✓	✓	✓	✓	✓
TimestampReset	✓	✓	✓	✓	✓	✓	✓	✓	✓	✓	✓	✓	✓	✓	✓	✓	✓	✓	✓	✓	✓	✓	✓	✓

Various Imaging Controls

This camera is equipped with various Imaging Control functions. By using these functions, effects such as reduction of random noise can be obtained.

The Imaging Control function has the following operation modes.

- HDR (High Dynamic Range)
- Frame Integration (Frame) mode
- Frame Integration (Exposure) mode

This chapter also explains the Video Process Bypass mode, in which the output of the image sensor is output directly from the camera.

Each operation mode has restrictions on the Pixel Format that can be used and the functions that can be used at the same time.

■ Each Imaging Control mode and Pixel Format

	FrameIntegrationMode (Frame)	FrameIntegrationMode (Exposure)	HDR (Linear)	HDR (Knee)	VideoProcess BypassMode
Bayer8	✓			✓	✓
Bayer10	✓			✓	✓
Bayer12	✓			✓	✓
Bayer14		✓	✓		✓
Mono8	✓			✓	✓
Mono10	✓			✓	✓
Mono12	✓			✓	✓
Mono14		✓	✓		✓

■ Functions available at the same time as each Imaging Control mode

	FrameIntegrationMode (Frame)	FrameIntegrationMode (Exposure)	HDR (Linear)	HDR (Knee)	VideoProcess BypassMode
AnalogBaseGain	✓	✓			✓
DigitalGain	✓	✓	✓	✓	
LUT	✓			✓	
Gamma	✓			✓	
Shading	✓	✓	✓	✓	
BlackLevel	✓	✓	✓	✓	
EdgeEnhancer	✓			✓	
SequencerMode			✓	✓	✓
MultiROI Mode			✓	✓	✓
ExposureMode(Off)			✓	✓	✓
ExposureMode(Timed)	✓	✓	✓	✓	✓
ExposureMode(TriggerWidth)			✓	✓	✓

*) FrameIntegration(Frame, Exposure) modes work only in TriggerMode.

HDR (High Dynamic Range)

When imaging scenes with bright and dark areas, it can be difficult to achieve a good exposure. Setting the exposure for the bright areas can leave the dark areas completely black, while setting the exposure for the dark areas can oversaturate the bright areas. The HDR function can extend the exposure range of the camera to capture details in both bright and dark areas within a scene.

The HDR function has two output modes: Linear mode (14-bit output) and Knee mode (8, 10, 12-bit output)

■ How this function works

1. Take one-frame image and acquire by changing image sensor analog gain to low and high.
2. An image captured with low gain is increased Digital Gain.
3. Two images are combined into one frame of 14bit image data.

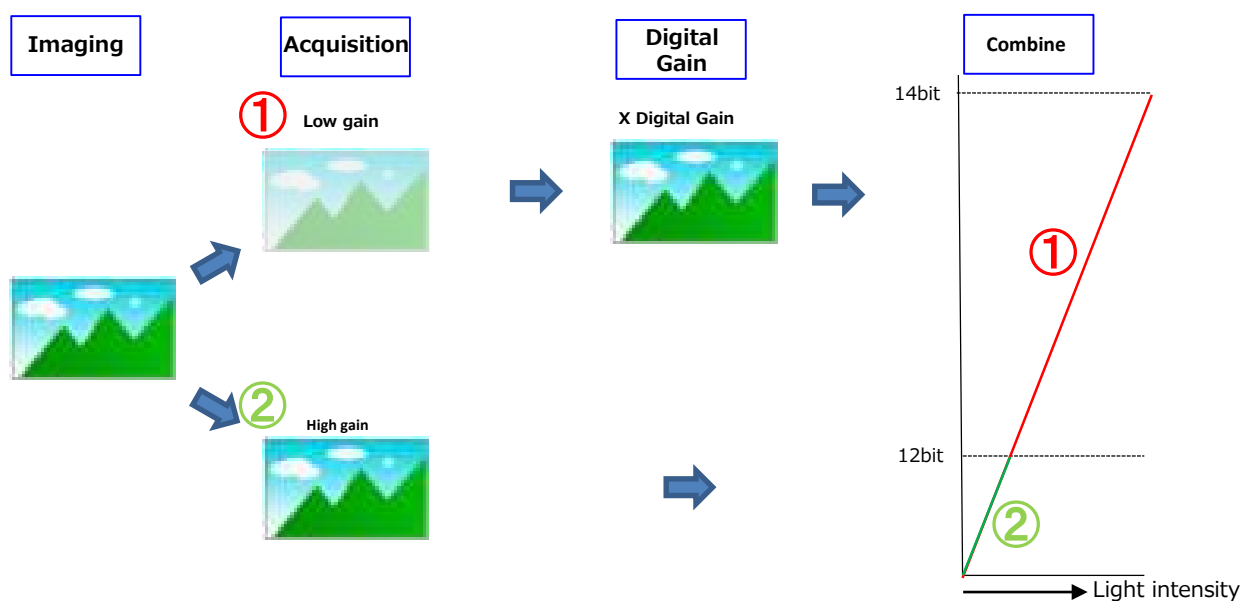

4. Output

- In Linear mode, the synthesized 14-bit image is output as it is.
- In Knee mode, the synthesized 14bit image is Knee converted and output in 8bit, 10bit or 12bit image.
[HDRKneePoint], [HDRKneeSlope] can be set

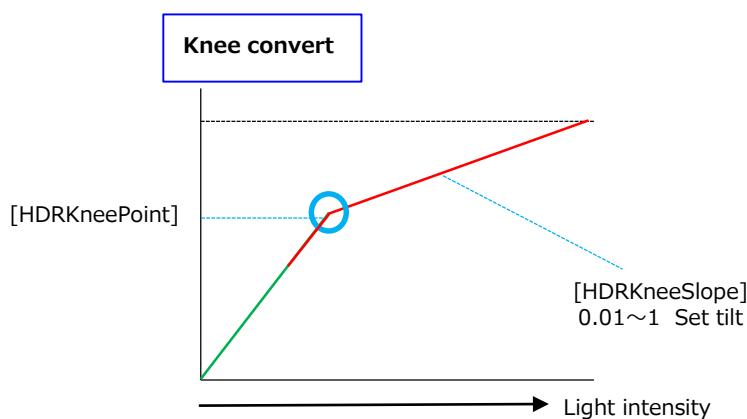

[HDRKneePoint] Set the value in the range of 0 to 4095 with 12-bit.

[HDRKneeSlope] Set the tilt (vertical ÷ horizontal).

■ Maximum Frame Rate Reference

The table below shows the maximum frame rate in HDR (Knee, Linear) mode.

HDR(Knee) mode

[Theoretical value]

	PixelFormat	Width	Height	Maximum frame rate(fps)
CXP12-2	Mono8/Bayer8	8192	5460	16
		8192	4320	20
		4096	2728	32
	Mono10/Bayer10	8192	5460	16
		8192	4320	20
		4096	2728	32
	Mono12/Bayer12	8192	5460	16
		8192	4320	20
		4096	2728	32

HDR(Linear) mode

	PixelFormat	Width	Height	Maximum frame rate(fps)
CXP12-2	Mono14/Bayer14	8192	5460	16
		8192	4320	20
		4096	2728	32

Frame Integration (Frame) mode

Outputs one frame image that is the average of the captured values for all pixels in the 2-8 frames imaged. As a result, high-quality images with reduced random noise can be obtained.

This mode is enabled when [Frame Integration Mode] in [Imaging Control] is set to [Frame].

Use [Frame Integration Frame Number] to determine how many frames of one image to calculate.

Note

- Frame Integration (Frame) mode works in Trigger mode only.

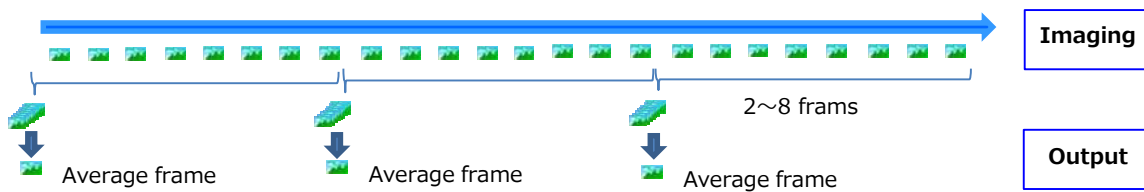

■ Maximum Frame Rate Reference

The table below shows the maximum frame rate in Frame Integration (Frame) mode.

The maximum frame rate differs for each [Frame Integration Frame Number].

[Theoretical value]

	PixelFormat	Width	Height	Maximum frame rate (fps)							
				2	3	4	5	6	7	8	
CXP12-4 CXP12-2	Mono8/Bayer8	8192	5460	5.7	3.8	2.8	2.3	1.9	1.6	1.4	
	Mono10/Bayer10	8192	4320	7.2	4.8	3.6	2.9	2.4	2.0	1.8	
	Mono12/Bayer12	4096	2728	11.0	7.6	5.7	4.5	3.8	3.2	2.8	

Frame Integration (Exposure) mode

Two frame images are taken with different exposure times, and two frame images (12bit x 2) are added to calculate one frame image (13bit) inside the camera.

The output Pixel Format is 14bit output as follows.

SP-45001C-CXP2A : BayerRG14, BayerGR14, BayerGB14, BayerBG14

SP-45001M-CXP2A : Mono14

This mode is enabled when [Frame Integration Mode] in [Imaging Control] is set to [Exposure].

Set the exposure time in [Frame Integration Exposure1] and [Frame Integration Exposure2].

Note

- Frame Integration (Exposure) mode works in Trigger mode only.

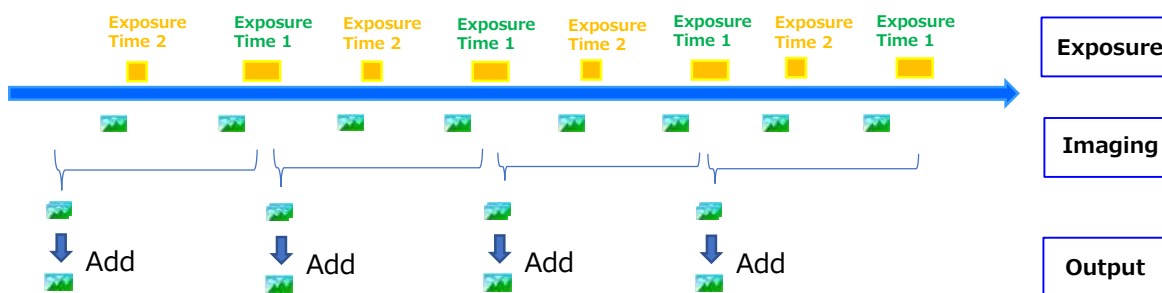

■ Maximum Frame Rate Reference

The table below shows the maximum frame rate in Frame Integration (Frame) mode.

The maximum frame rate differs for each [Frame Integration Frame Number].

[Theoretical value]

	PixelFormat	Width	Height	Maximum frame rate (fps)
CXP12-2	Mono14/Bayer14	8192	5460	5.7
		8192	4320	7.2
		4096	2728	11.0

VideoProcessBypassMode

The video process bypass mode is a function that bypasses internal video processing on the camera. When bypass is enabled, the sensor output and camera output data can be set to the same bit width.

12-bit outputs can only be performed in bypass mode.

■ Functions available in VideoProcessBypassMode

The following functions can be used in video process bypass mode.

AnalogBaseGain, BlemishCompensation, BinningVertical, BinningHorizontal

*)BinningVertical and BinningHorizontal work in Average mode only.

■ Functions unavailable in VideoProcessBypassMode

Gain, Gamma, Shading, Knee, Enhancer, BlackLevel, LUT, BalanceWhiteAuto, GainAuto, SequencerGain, SequencerBlackLevel, SequencerLUTEnable

Timing chart

- When [ExposureMode] is [Timed]
 - FrameStartTrigger On

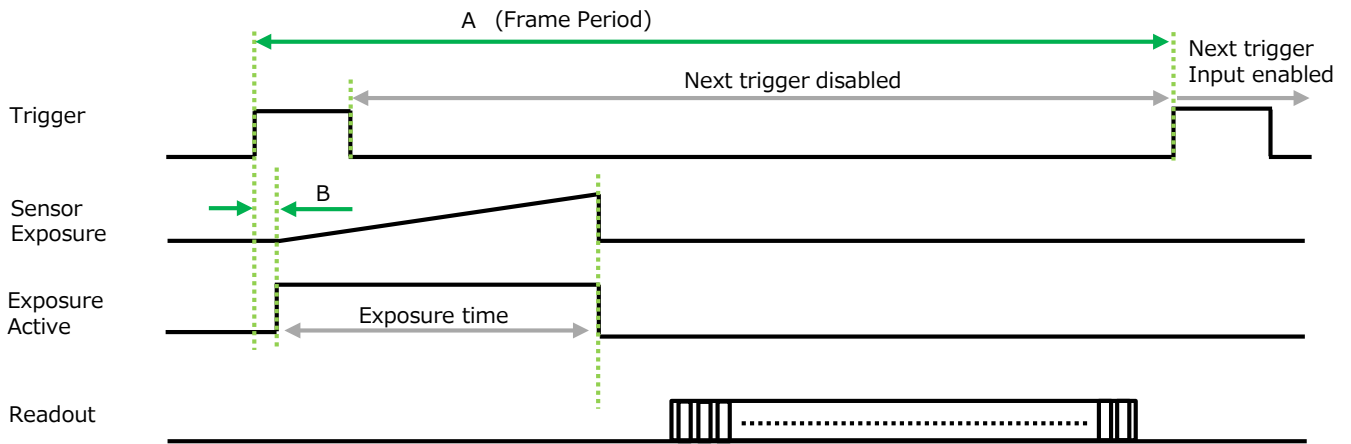

CXP12-2

PixelFormat	Frame Period [A] (usec)	Period From Trigger start edge to Exposure start [B] (usec)
Binning Off		
Mono8	26247	41.4
Mono10	31153	41.4
Mono12	31153	41.4
BayerRG8	26247	41.4
BayerRG10	31153	41.4
BayerRG12	31153	41.4
Horizontal Binning On		
Mono8	26247	41.5
Mono10	31153	41.4
Mono12	31153	41.5
Vertical Binning On		
Mono8	26247	41.5
Mono10	31153	41.4
Mono12	31153	41.4
Horizontal Binning On & Vertical Binning On		
Mono8	26247	41.5
Mono10	31153	41.4
Mono12	31153	41.5

■ When [ExposureMode] is [TriggerWidth]

● FrameStartTrigger On

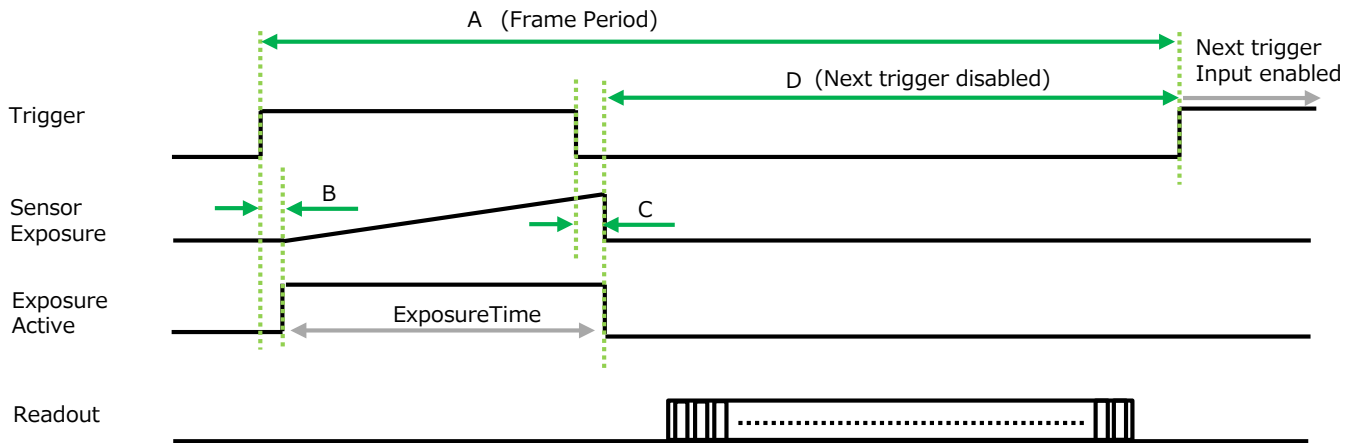

CXP12-2

PixelFormat	Frame Period [A] (usec)	Period From Trigger start edge to Exposure start [B] (usec)	Period From Trigger end to Exposure end [C] (usec)	Period From Exposure end to next Trigger Start [D] (usec)
Binning Off				
Mono8	26667	41.4	41.4	26541
Mono10	31847	41.4	41.4	31727
Mono12	31847	41.4	41.4	31722
BayerRG8	26667	41.4	41.4	26541
BayerRG10	31847	41.4	41.4	31727
BayerRG12	31847	41.4	41.4	31722
Horizontal Binning On				
Mono8	26738	41.4	41.4	26618
Mono10	31949	41.4	41.4	31823
Mono12	31847	41.4	41.4	31727
Vertical Binning On				
Mono8	26667	41.4	41.4	26547
Mono10	31949	41.4	41.4	31823
Mono12	31949	41.4	41.4	31829
Horizontal Binning On & Vertical Binning On				
Mono8	26525	41.4	41.4	26400
Mono10	31949	41.4	41.4	31823
Mono12	31949	41.4	41.4	31829

Maximum Frame Rate Reference

The table below shows the maximum frame rate in normal mode.

[Theoretical value]

	PixelFormat	Width	Height	Maximum frame rate(fps)
CXP12-2	Mono8/Bayer8	8192	5460	38
		8192	4320	48
		4096	2728	76
	Mono10/Bayer10	8192	5460	32
		8192	4320	40
		4096	2728	64
	Mono12/Bayer12	8192	5460	32
		8192	4320	40
		4096	2728	64

Calculate the maximum frame rate (approximate)

Maximum frame rate

This section describes how to calculate the maximum frame rate in normal mode, excluding HDR (Linear, Knee) mode and Frame Integration (frame, Exposure) mode.

■ LinePeriod[μ s]

The Value (A) is a fixed value for each LinkConfig(CoaXPress) and PixelFormat. Please refer to the table below.

LinkConfig	PixelFormat	(A)	LinkConfig	PixelFormat	(A)
CXP12-2	8	305	CXP6-2	8	432
	10	366		10	540
	12	366		12	648
CXP12-1	8	432	CXP6-1	8	864
	10	540		10	1078
	12	648		12	1294

Calculate the LinePeriod[μ s] using the following formulas.

$$\text{LinePeriod}[\mu\text{s}] = (A) \div 64.8$$

■ Maximum frame rate[Hz]

Calculate the Maximum frame rate [Hz] using the following formulas.

$$\text{Maximum frame rate}[\text{Hz}] = 1 \div (\text{LinePeriod}[\mu\text{s}] \times (\text{Height} + 33)) \times 1000000$$

The maximum exposure time[μ s] that can be taken in this case can be calculated by the following formula.

$$\text{Maximum exposure time}[\mu\text{s}] = 1000000 \div \text{Maximum frame rate}[\text{Hz}] - (14 \times \text{LinePeriod}[\mu\text{s}]) - 1$$

If you want to use a target exposure time[μ s] that is longer than the maximum exposure time [μ s], calculate the frame rate [Hz] using the following formula.

$$\text{Frame rate}[\text{Hz}] = 1 \div (\text{Target exposure time}[\mu\text{s}] + 14 \times \text{LinePeriod}[\mu\text{s}] + 1) \times 1000000$$

Caution

About Height in MultiROI mode.

If there is an unused area in the vertical direction between the specified areas, add 8 to the total height of the areas to be used to obtain the Height in the above formula. If the number of lines for unused area is smaller than 8, add the number of lines for unused area instead of 8.

The same addition must be done for the number of unused areas.

If there is no unused area in the vertical direction between the specified areas, use the value obtained by adding the heights of the areas to be used.

Gain Control

First, set AnalogBaseGain to be processed in the image sensor. AnalogBaseGain can be adjusted in 3 levels: 0dB, 6dB, 12dB.

Next, in SP-45001C-CXP2A, adjust the [AnalogAll] (master gain) setting first, and then adjust the [AnalogRed],[DigitalRed], [AnalogBlue], and [DigitalBlue] setting values to perform fine adjustment.

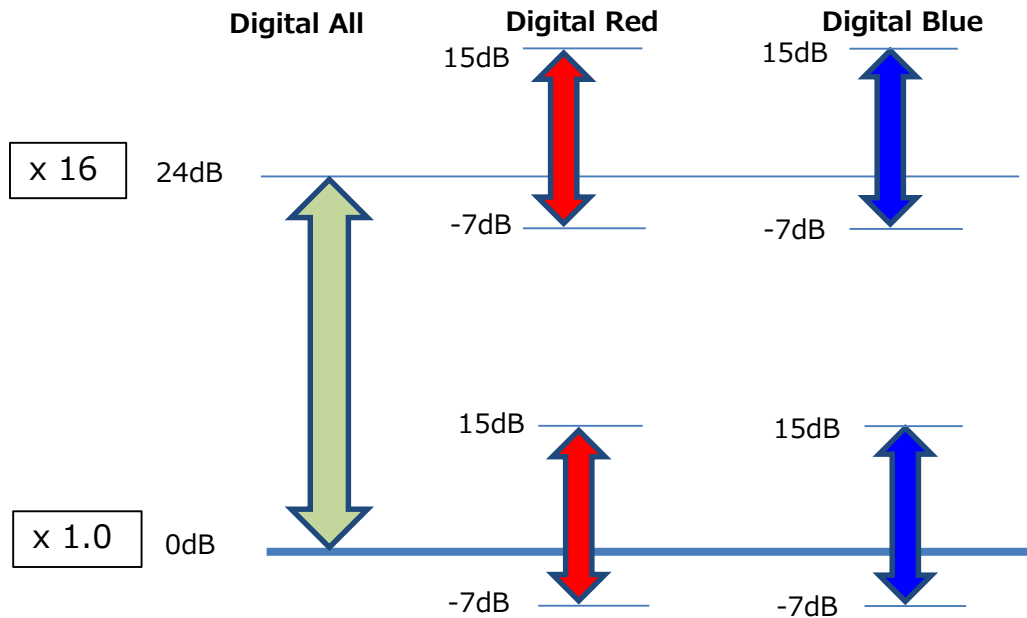

In SP-45001M-CXP2A, adjust the [AnalogAll] (master gain) setting.

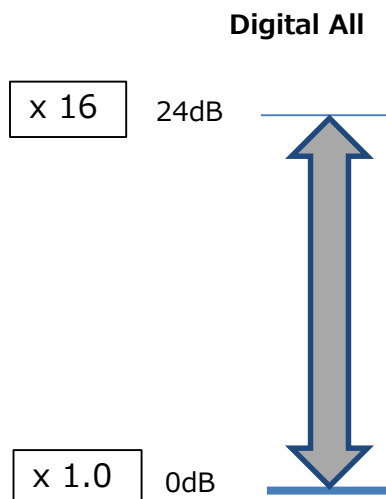

■ Automatic Gain Level Control

Set [GainAuto] to [Continuous] to control the gain level automatically.

When [GainAuto] is set to [Continuous], you can configure the conditions for automatic adjustment in detail.

When [GainAuto] is set to [Continuous], automatic adjustment will be performed continuously.

When [GainAuto] is set to [Once], automatic adjustment will be performed only once.

White Balance

To adjust the white balance automatically, set [BalanceWhiteAuto] to Once (automatic adjustment only once) or Continuous (automatic adjustment always).
 The metering area can be limited for automatic adjustment. To limit the metering area, specify each of the 16 areas with [AWBAreaSelector] and set [AWBAreaEnable] to True or False.

■ 16 areas

HighLeft	HighMidLeft	HighMidRight	HighRight
MidHighLeft	MidHighMidLeft	MidHighMidRight	MidHighRight
MidLowLeft	MidLowMidLeft	MidLowMidRight	MidLowRight
LowLeft	LowMidLeft	LowMidRight	LowRight

In addition, the white balance has been adjusted in advance for specific color temperature lighting.

It is possible to select from the following five presets.
 (Color temperature for preset : 4000K, 4600K, 5600K, 6500K, 7500K)

Color temperature

The adjustable range of white balance for this camera is 3000K to 9000K.
 Please refer to the figure below for an overview of the relationship between various lighting types and color temperature.

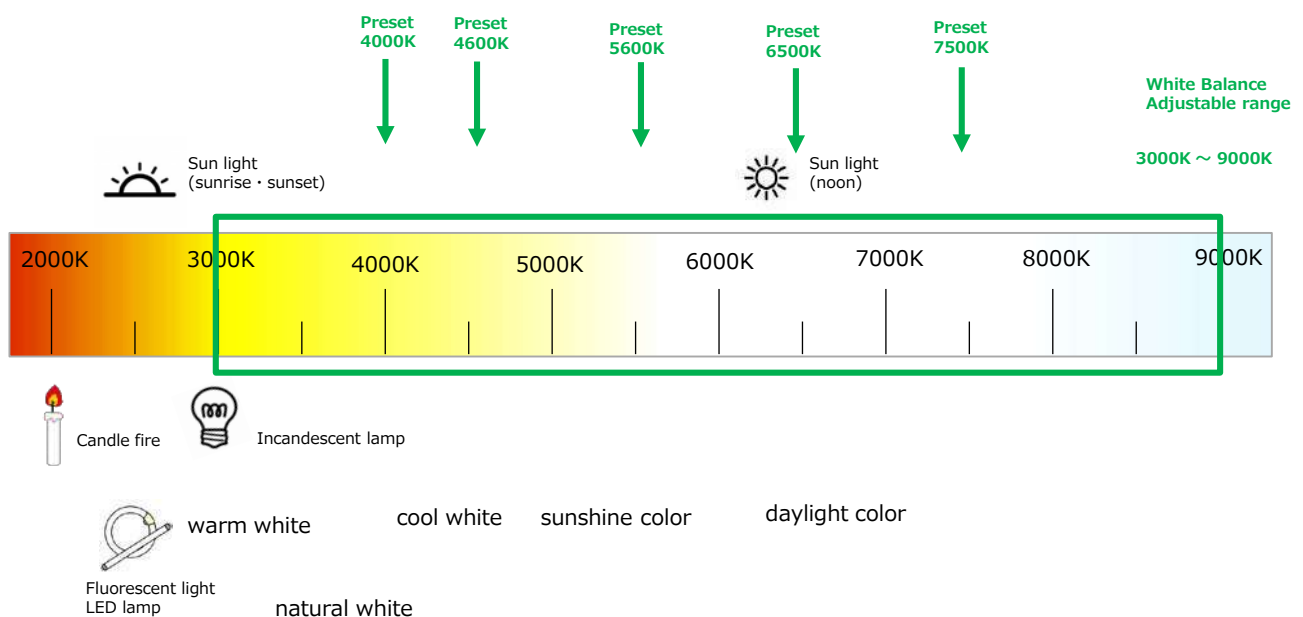

ALC (Automatic Level Control) Function

The ALC (automatic level control) function combines the automatic gain control (AGC/Auto Gain Control) and automatic exposure control (ASC/Auto Shutter Control) functions, and is capable of handling various changes in brightness. The function operates as follows in response to changes in brightness.

Change from bright to dark: ASC → AGC

Change from dark to bright: AGC → ASC

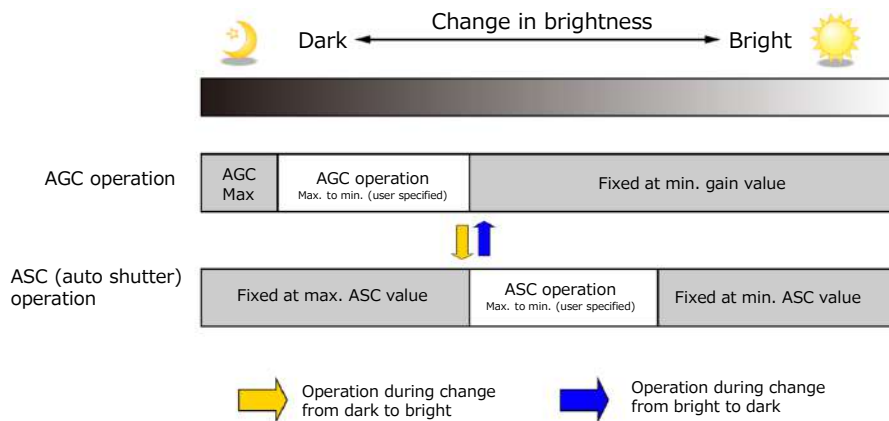

■ To use the ALC function

Set [GainAuto] or [ExposureAuto] or both to [Continuous] mode. Configure the minimum value, maximum value, etc. for AGC and ASC under [JAICustomControlALC]. The target video levels for AGC and ASC are configured in [ALCReference]. For example, when [ALCReference] is set to 95%, video levels will be maintained at 95% using AGC and ASC.

Gamma Function

The gamma function corrects the output signals from the camera beforehand (reverse correction), taking into consideration the light-emitting properties of the monitor display. As the light-emitting properties of the monitor are not linear, the entire image may be darker or the gradation in the dark areas may be less noticeable when camera outputs are displayed without processing.

The gamma function can be used to correct the camera signals with an opposite-direction curve and produce a display that is close to linear.

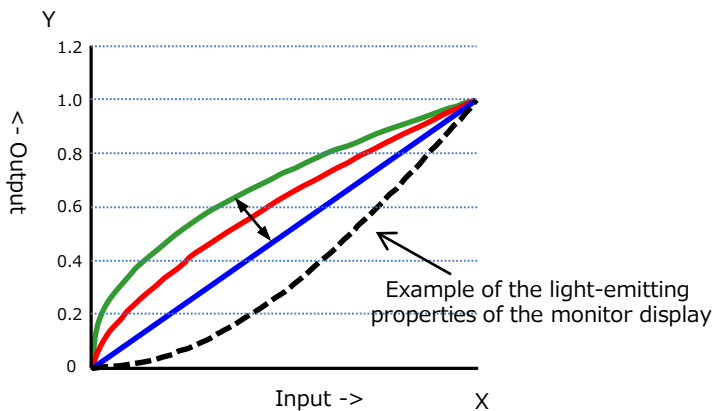

■ To use the gamma function

Configure the settings as follows.

Item	Setting value / selectable range	Description
Gamma	0.45, 0.5, 0.55, 0.6, 0.65, 0.75, 0.8, 0.9, 1.0	Select the gamma correction value.
LUTMode	Gamma	Use gamma.

Note

You can use the LUT function to configure a curve with more detailed points. For details, see "Lookup Table (LUT)".

LUT (Lookup Table)

The LUT function is used to generate a non-linear mapping between signal values captured on the sensor and those that are output from the camera. You can specify the output curve using 257 setting points (indexes).

■ To use the LUT function

Configure the settings as follows.

Item	Setting value / selectable range	Description
LUTMode	LUT	Use LUT.
LUTSelector*	Red, Green, Blue	Select the LUT channel to control.
LUTIndex	0 ~ 256	Select the LUT index to configure. Indexes represent the possible pixel values captured on the sensor, from the lowest value (Index 0) to the highest (Index 256). For example, Index 0 represents a full black pixel and Index 256 represents a full white pixel.
LUTValue	0 ~ 4095	Set the LUT output value for the selected index.

*) SP-45001C-CXP2A only

■ LUT Value

LUT values range from 0 at the lowest to 4095 at the highest. Linear interpolation is used to calculate LUT values between the index points.

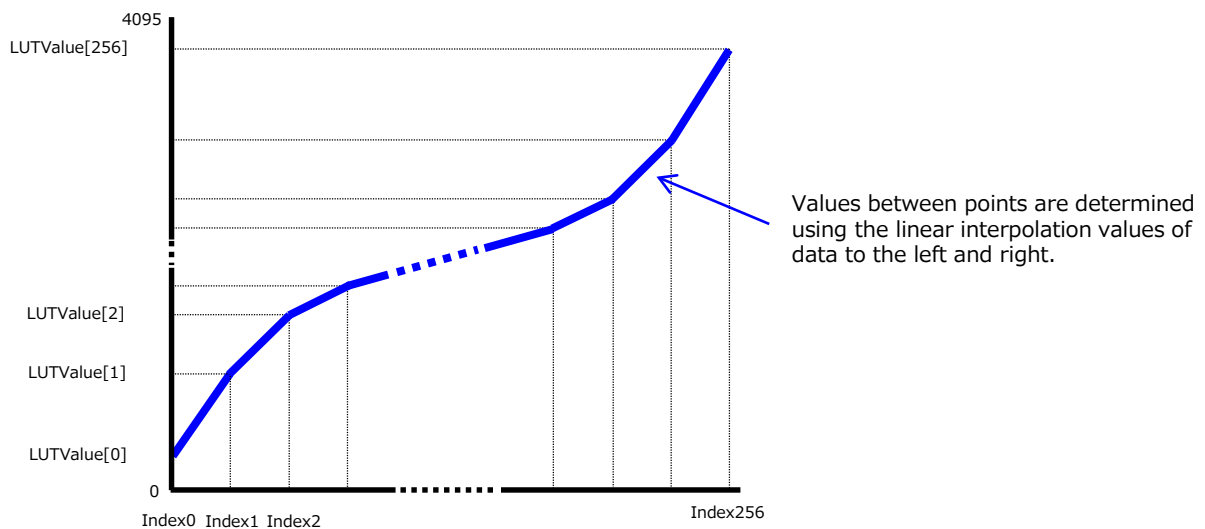

BlemishCompensation

Multiple defective pixels that are not adjacent to each other can occur on conventional CMOS sensor cameras.

This camera features a function that interpolates defective pixels using the surrounding pixels. Up to 3183 pixels can be corrected. Pixel interpolation can be performed via automatic detection or point-by-point manual settings.

■ Automatic detection

Automatic detection can only detect lit defective pixels (i.e., white blemishes).

1 Shield the camera sensor.

If a lens is attached, use the lens cap as a shield, for example.

2 Configure the threshold level for defective pixel detection.

Up to 3183 pixels can be corrected. The threshold value is specified as a percentage. The default setting is "10" with 10% of the full scale (100%) specified as the threshold value.

3 Execute [BlemishDetect] to start automatic detection.

After detection, the interpolation data is saved to the camera's internal memory.

To check the number of interpolated pixels after automatic detection

You can check the number of pixels interpolated via automatic detection by loading the BlemishNum data.

■ Manual configuration

1 Select the index in [BlemishCompensationIndex].

You can select from 1 to 3183. However, configure the indexes in order starting with the smallest index. If you skip indexes while configuring settings, interpolation may not be performed.

2 Specify the pixel points for interpolation using the [BlemishCompensationPositionX] and [BlemishCompensationPositionY] settings.

You can configure values that are within the total effective pixel area. Specify pixels for which interpolation is not necessary as -1. If 0 is specified, the first line or first pixel will be interpolated.

Note

BlemishCompensationDataClear[BlemishCompensationIndex], you can return a specific pixel correction setting to the default value (storage not required).

3 Execute [BlemishStore].

Blemish compensation data will be stored.

4 Set [BlemishEnable] to [True], and execute interpolation.

If it is set to [False] , Blemish compensation is not effective.

Shading Correction

The ShadingCorrection function corrects non-uniformity (i.e., shading) in the amount of light generated by the lens and lighting equipment. Using this function allows correction even if top, bottom, left, and right shading is not symmetrical in relation to the center of the screen (H, V).

This function can be used even when the effective image area is limited (an area with both Width and Height set to more than 128 must be configured) by the ROI function. In such cases, the correction area is included in the image area configured by the ROI.

For a full image, the number of correction blocks is 64 (H) × 43 (V) blocks and calculation errors in the correction data are minimized due to the small interpolation areas. Each block is 128 × 128 pixels. The total size of the blocks is 8192 (H) × 5504 (V), but the actual number of effective pixels for the camera is 8192 (H) × 5460 (V). The ineffective peripheral areas will be deleted internally on the camera automatically.

When using ROI, the number of blocks and the number of pixels that comprise each block differ from a full image.

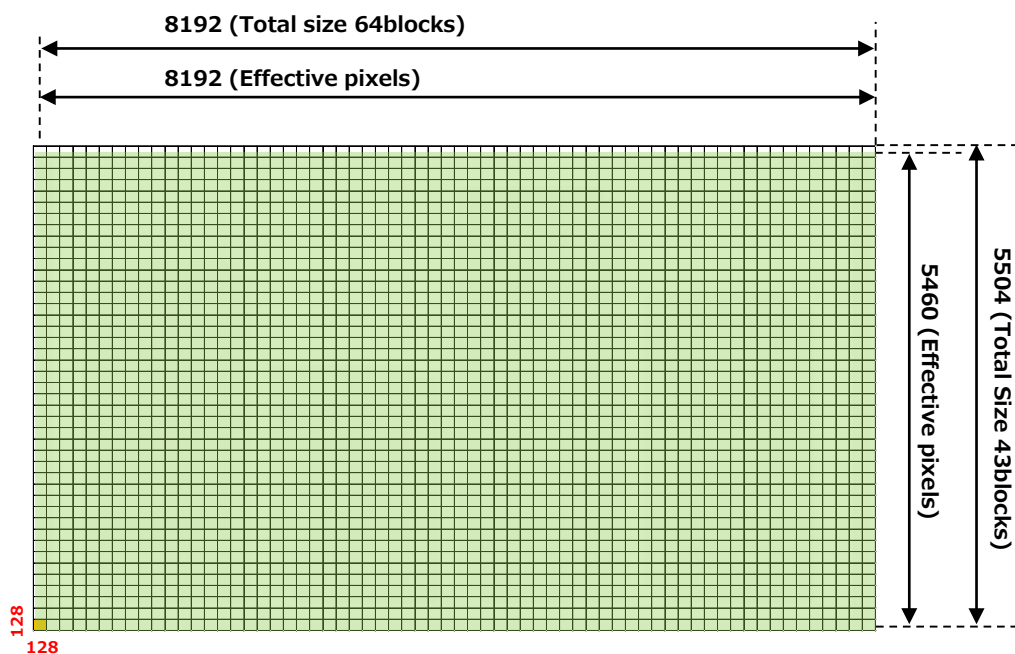

The following shading correction modes are available on the camera.

■ FlatShading

Correction is performed using the area of the screen with the highest brightness level as the reference, and adjusting the brightness levels of the other areas to match this level.

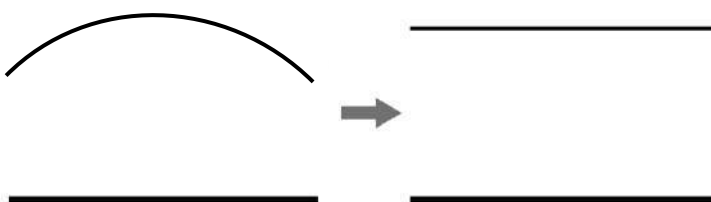

■ ColorShading (SP-45001C-CXP2A only)

R-channel and B-channel properties are adjusted to using the G-channel shading properties as a reference.

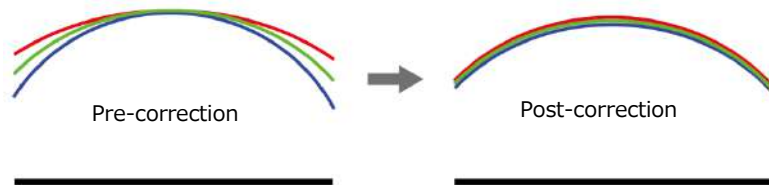

Caution

- For FlatShading and ColorShading, the maximum amount of correction gain for all pixels is limited to 8 times the amount of gain before correction. (The amount of gain cannot be increased to more than 8 times the amount of gain from before correction.)
- If the area in the screen with the highest brightness level is 175 LSB or less (during 10-bit video output), proper correction is not possible.
- When using the image flip function (ReverseX, ReverseY), set both ReverseX and ReverseY to Off and execute calibration. If the image flip function is enabled shading correction will not be performed correctly. After executing calibration, set to enable the image flip function.

■ To use the shading correction function

Configure the settings as follows.

Item	Setting value	Description
ShadingCorrectionMode	FlatShading, ColorShading	Select the shading correction mode.
ShadingMode	User1, User2, User3, Off	Select the user area to which to save the shading correction value.

Display a white chart under a uniform light, and execute [PerformShadingCalibration].

Note

After shading correction is executed, the shading correction value is automatically saved to the user area selected in [ShadingMode].

Binning Function

SP-45001M-CXP2A only

The binning function allows you to combine the signal values of clusters of adjacent pixels to create improved virtual pixels. Using the function results in images with lower pixel resolution and higher sensitivity.

Horizontal Binning performs addition or averaging digitally.
Vertical Binning performs addition within the image sensor.

ROI Function (Single ROI)

The ROI (region of interest) function allows you to output images by specifying the areas to scan. Specify the area to scan by specifying width, height, and horizontal/vertical offset values under [ImageFormatControl].

For details on how to configure the settings, see “Configuring the Output Format”. You can increase the frame rate by specifying a lower height, as the number of lines scanned decreases. The setting ranges for the ROI function's readable area based on the Binning setting (BinningHorizontal, BinningVertical) are as follows.

Width (pixels)	Height (lines)
BinningHorizontal Off: 128 to 8192 step 128	BinningVertical Off: 8 to 5460 step 4
BinningHorizontal On: 64 to 4096 step 64	BinningVertical On: 8 to 2730 step 2

Offset X (pixels)	Offset Y (lines)
BinningHorizontal Off: 0 to 8064 step 128	BinningVertical Off: 0 to 5452 step 4
BinningHorizontal On: 0 to 4032 step 64	BinningVertical On: 0 to 2722 step 2

■ Without Binning

[BinningHorizontal] : 1
[BinningVertical] : 1

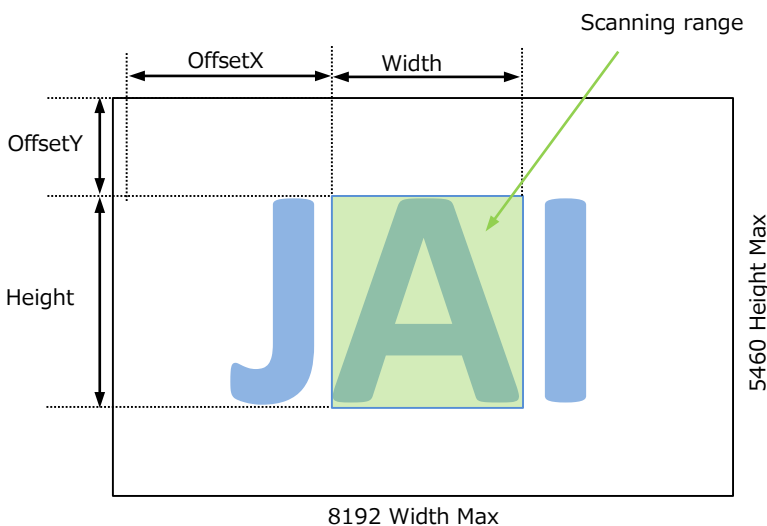

■ With Binning

[BinningHorizontal] : 2
[BinningVertical] : 2

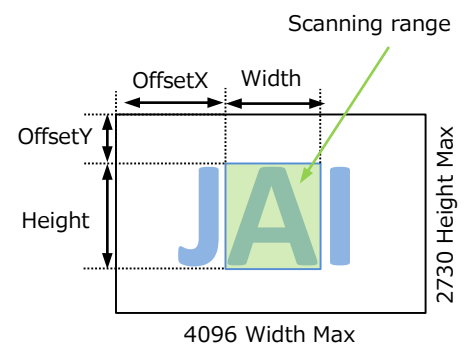

ROI Function (Multi ROI)

In the Multi ROI mode, you can specify up to 64 scanning areas for a single-frame image. The areas cannot overlap.

The Multi ROI mode can be used only when both the Sequencer mode and the Shading mode are off.

Set [MultiROIControl]->[MultiRoiMode] On. Select from the eight indexes in [MultiRoiIndex] then set [MultiRoiWidth], [MultiRoiHeight], [MultiRoiOffsetX] and [MultiRoiOffsetY].

And set the maximum index number to be enabled to [MultiRoiVerticalEnableNumber] and [MultiRoiHorizontalEnableNumber].

■ Example

To use four areas as shown below, refer to the following.

1. Set [MultiROIControl]->[MultiRoiMode] On.
2. Select "0" in [MultiRoiIndex].
Set [MultiRoiWidth], [MultiRoiHeight], [MultiRoiOffsetX] and [MultiRoiOffsetY].
3. Select "1" in [MultiRoiIndex].
Set [MultiRoiWidth], [MultiRoiHeight], [MultiRoiOffsetX] and [MultiRoiOffsetY].
4. Set 2 to [MultiRoiVerticalEnableNumber].
5. Set 2 to [MultiRoiHorizontalEnableNumber].

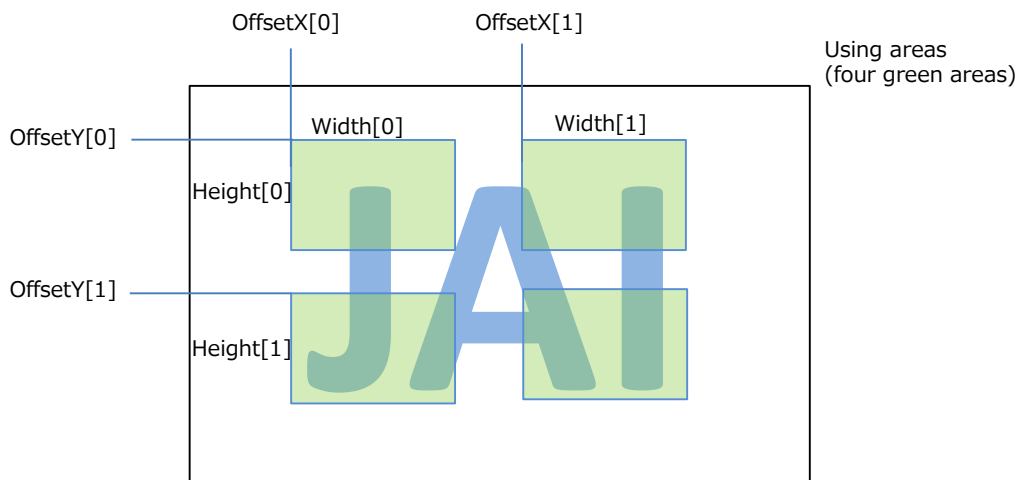

Output image

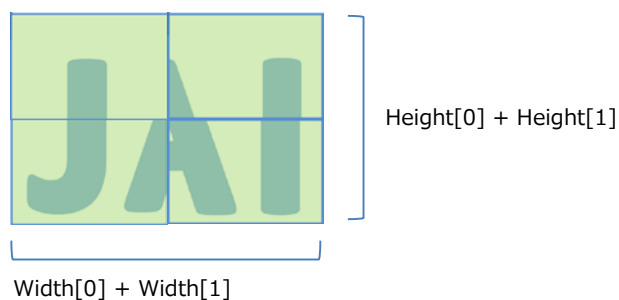

Overlay mode

In this mode, you can check the readout area when using the Multi ROI function. The area that is not read out is displayed with the brightness reduced to half.

This makes it possible to set and adjust the readout area while checking the target area on the screen.

To enable this function, set it in [OverlayMode] of [Image Format Control].

When [Overlay Mode] is set to MultiRoiAreaMode, the non-target area is displayed with half the brightness as shown below.

Caution

To set [Overlay Mode] to [MultiRoi Area], [MultiRoi Mode] must be set to Off in advance.

■ OverlayMode = MultiRoiArea



In this mode, if [Overlay Mode] is set to AWBAreaMode and ALCAreaMode, you can check the photometry areas of WhiteBalance and ALC. In the non-target area as shown below, the brightness is displayed at half.

■ OverlayMode = AWBAreaMode or ALCAreaMode

HighLeft	HighMidLeft	HighMidRight	HighRight
MidHighLeft	MidHighMidLeft	MidHighMidRight	MidHighRight
MidLowLeft	MidLowMidLeft	MidLowMidRight	MidLowRight
LowLeft	LowMidLeft	LowMidRight	LowRight

Image flip function

Using this function, you can output the image by inverting it horizontally and/or vertically.

In [ImageFormatControl] settings,
To reverse the image horizontally, set [ReverseX] to True.
To reverse the image vertically, set [ReverseY] to True.

In SP-45001C-CXP2A, the Bayer array is changed by the image flip function.

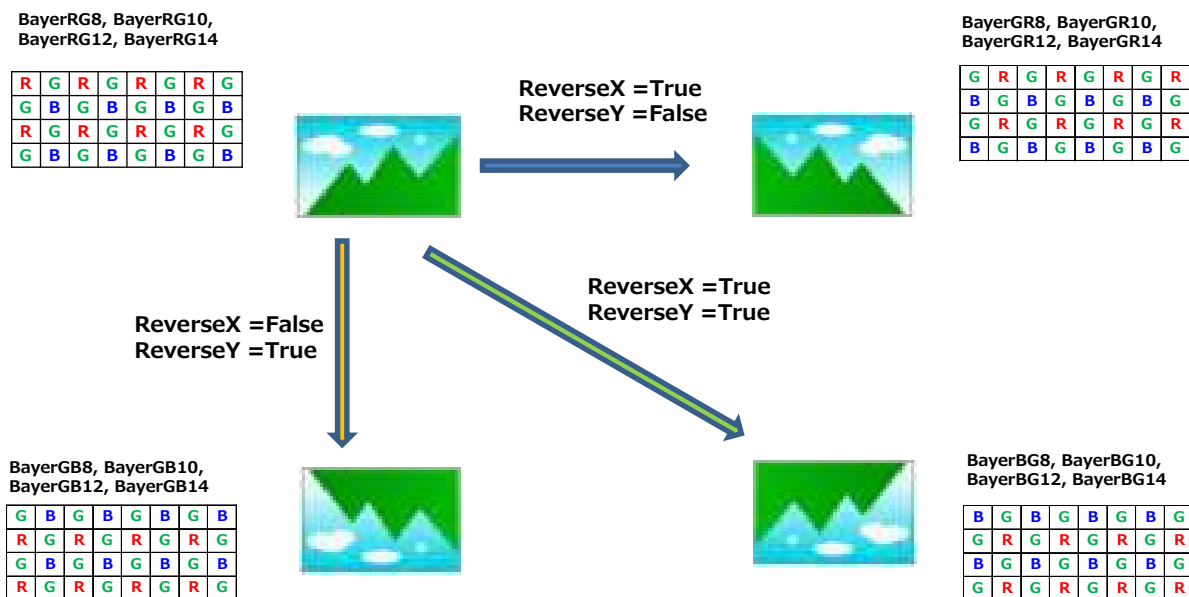

Edge enhancer

SP-45001M-CXP2A is equipped with an edge enhancer function for enhancing the contrast of lines or edges within images.

The edge enhancer function is enabled when EnhancerEnable[Edge] is set to True. Four enhancement levels are available: Low, Middle, High, and Strong.

CXP Link Sharing function

This function has two operation modes (Sharing mode and Duplicate mode).

■ Sharing mode

This camera can be connected to multiple PCs and the captured images can be divided and sent to each PC.

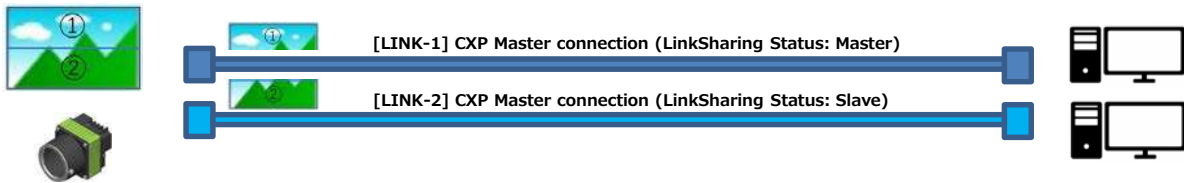

■ To Use Sharing mode

1. Set [CxpLinkSharingEnable] of [TransportLayerControl] to True.
2. Set the number of divisions of the captured image in the horizontal direction with [CxpLinkSharingHorizontalStripeCount]. In the case of the above figure, 1 is set. Set the number of divisions of the captured image in the vertical direction with [CxpLinkSharingVerticalStripeCount]. In the case of the above figure, 2 is set.
3. It is possible to overlap the divided images of ① and ②. The amount of overlap can be 0 pixels/lines (no overlap), 64 pixels/lines, or 128 pixels/lines. The amount can be set independently in the horizontal and/or vertical directions.
Horizontal : [CxpLinkSharingHorizontalOverlap]
Vertical : [CxpLinkSharingVerticalOverlap]
4. It is necessary to restart this camera and tools after setting.
(Each setting (CxpLinkXXX) is automatically saved when the setting is changed.)

It is also possible to divide the captured image shown below.



[CxpLinkSharingHorizontalStripeCount] = 2
[CxpLinkSharingVerticalStripeCount] = 1

■ Duplicate mode

This camera can be connected to multiple PCs and the same captured image can be copied and sent to each PC.

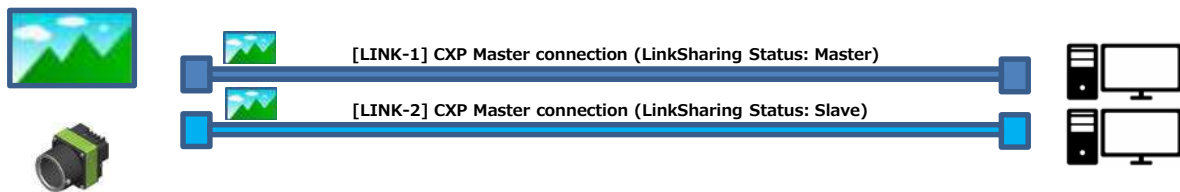

■ To Use Duplicate mode

1. Set the number of destinations (0 to 2) in [CxpLinkSharingDuplicateStripe] of [TransportLayerControl]. The number of destinations that can be set differs depending on the CXP connection mode with one PC.
 - [CXP12_X1] : 0,1,2 can be set.
 - [CXP6_X1] : 0,1,2 can be set.
 *) This function cannot be used in other CXP connection modes.
2. It is necessary to restart this camera and tools after setting.
(Each setting (CxpLinkXXX) is automatically saved when the setting is changed.)

Caution

- The CXP Link Sharing function (Sharing mode, Duplicate mode) can only be used with CXP 2.0. The CoaXPress frame grabber board used must support CXP 2.0 and CXP Link Sharing function.
 - You can check the current CXP version in [CxpVersion Used] of [Transport Layer Control]. If [CxpVersionUsed] is CXP 1.1, you cannot use the CXP Link Sharing function.
 - When using the CXP Link Sharing function (Sharing mode, Duplicate mode), PixelFormat is limited to Mono8 or Bayer RG8 only.
-

Event Control Function

The Event Control function is a function that outputs a signal change point inside the camera as information indicative of an event occurrence (event message).

■ Flow from Detecting an Event to Sending an Event Message

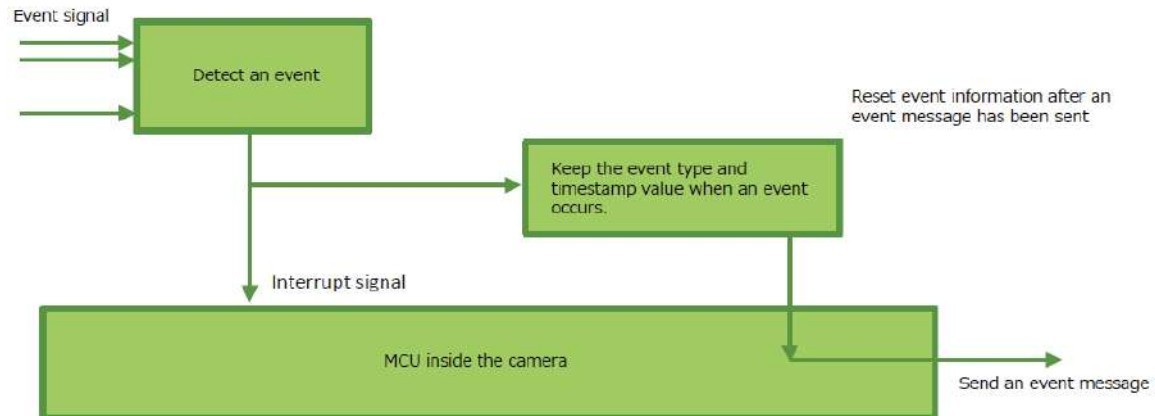

■ Events that Can Use the Event Control Function

Events that can use the Event Control function are as follows. You can specify whether or not to send an event message when an event occurs at each event.

AcquisitionStart,
AcquisitionEnd,
ExposureStart,
ExposureEnd,
Error

Cautions

This function can only be used with CXP 2.0 or later. The CoaXPress frame grabber board used must support CXP 2.0 and the Event Control function.

You can check the current CXP version in `CxpVersionUsed` of Transport Layer Control. If `CxpVersionUsed` is `CXP1.1`, you cannot use this function.

Sequencer Function

The Sequencer function lets you define up to 128 index combinations of exposure time, gain, ROI, and other settings which can be stepped through each time a trigger is received. This is particularly useful for quickly capturing multiple exposures of objects under inspection to adjust for areas or components with significantly different levels of reflectance. You can specify the next index in the stepping sequence and the order in which indexes are executed. Multiple indexes can also be executed repeatedly.

Two operation modes (TriggerSequencer mode and CommandSequencer mode) are available for the Sequencer function.

Note

Sequencer function can not be used with Multi ROI Function.

Caution

If the values of [ImageFormatControl] Width and Height are smaller than [SequencerControl] SequencerWidth and SequencerHeight, the image may not be output correctly.

When using SequencerWidth / SequencerHeight, set the Width and Height to the default values Width = 8192 and Height = 5460 in advance.

About indexes (imaging conditions)

Up to 128 indexes can be configured. The following settings can be configured for each index. However, SequencerFrameNumber and SequencerSetNext can only be configured in TriggerSequencer mode.

Trigger Sequencer mode

With this mode, the Sequencer Trigger "pattern" is predetermined by the user. The user defines up to 128 different "indexes." The items indicated in the above index can be configured for each index. The operation of this mode is controlled using the following five commands.

Caution

- In TriggerSequencer mode, the TriggerOverlap function of the FrameStart trigger is disabled and the operation is always Off.

[SequencerSetActive]

This allows you to confirm the index number displayed on next trigger reception.

[SequencerSetStart]

This configures the index number to execute at the start of TriggerSequencer mode.

[SequencerReset]

During TriggerSequencer mode operation, this switches the index number to be executed to that specified in [SequencerSetStart].

[SequencerRepetition]

This parameter applies to TriggerSequencer patterns which include an index whose [SequencerROINextIndex] is set to 0 (OFF). When the index whose [SequencerROINextIndex] is set to 0 (OFF) is finished executing, the value of Sequencer Repetition (range = 1-255) is decremented internally. If the result of the decrement is not zero, the TriggerSequencer pattern starts over from the index specified in SequencerSetStart. If the result of the decrement is zero, the status changes to Acquisition Stop and external triggers are not accepted.

Sample TriggerSequencer mode operation

User-defined Indexes (up to 128)

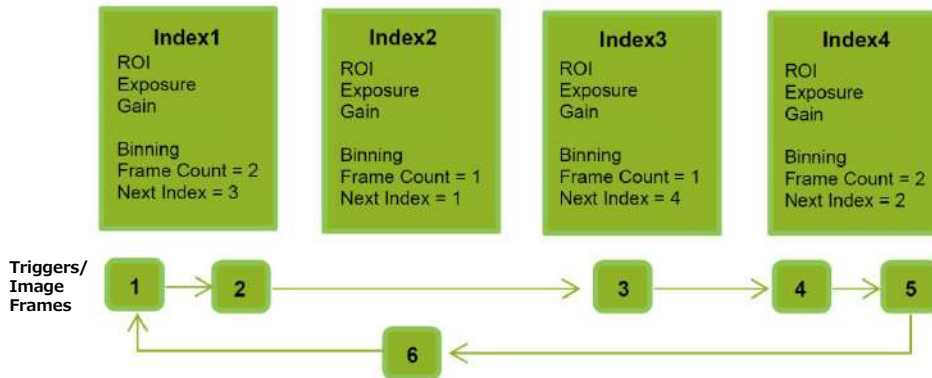

- 1** Specify "1" in [SequencerSetStart], and start TriggerSequencer mode with index 1.
- 2** Capture a 2-frame image with the first and second triggers.
- 3** For the next index, configure index 3 specified in [SequencerSetNext], and capture an image with the number of frames (number of triggers) specified in [SequencerFrameNumber].

Proceed to sequence from index 4 to index 2 to index 1.

Note

In addition to repeating multiple conditions as in the above example, you can specify "0" (which indicates the end of TriggerSequencer mode) in [SequencerSetNext] of index 2, and specify the number of repetitions in [SequencerRepetition].

Command Sequencer mode

As with TriggerSequencer mode, you can define up to 128 indexes beforehand in this mode. Set [SequencerCommandIndex] to point to one of your pre-configured indexes. This index will be executed on each trigger, until it is changed to point to a different index, typically by your vision application. In this way, Command Sequencer mode allows you to programmatically adjust your sequence in response to image analysis or input from other sensors.

Note

- The same index table will be executed for subsequent triggers unless the [CommandSequencerIndex] value is changed.
- [SequencerFrameNumber] and [SequencerSetNext] cannot be used in CommandSequencer mode.

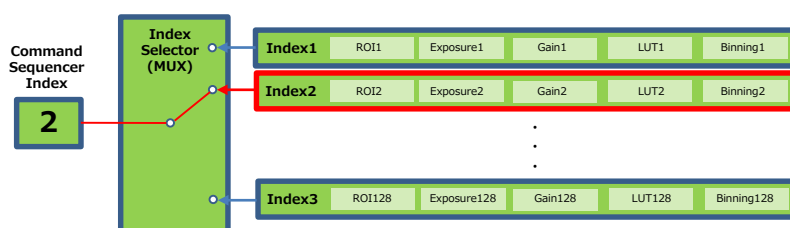

Pulse Generator

By using this function, any signal can be generated inside the camera.
 The following is an example of signal generation.

Settings

- PulseGeneratorStartPoint = 2
- PulseGeneratorEndPoint = 6
- PulseGeneratorLength = 10
- PulseGeneratorPulseWidth = 4
- PulseGeneratorClearSyncMode = AsyncMode

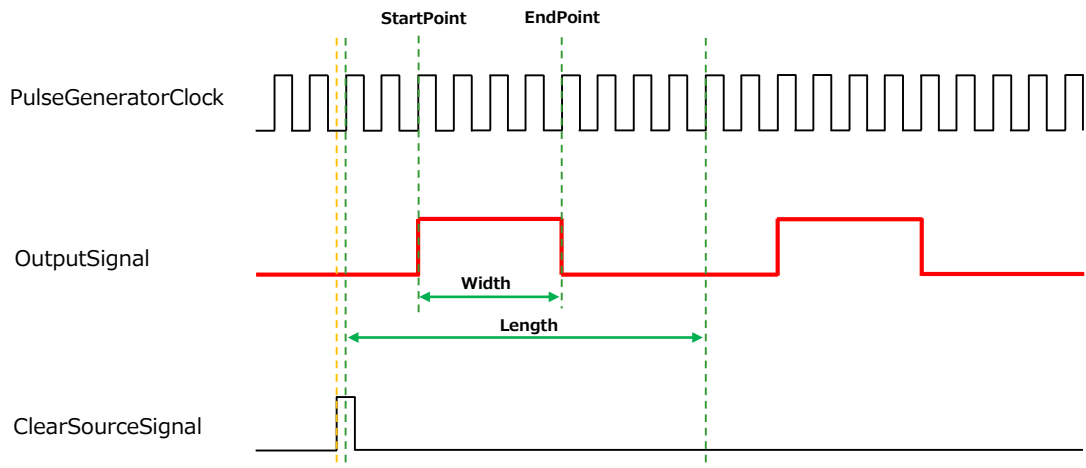

The table below shows the PulseGeneratorClearSource signals that can be set.

	Off	AcquisitionActive	FrameActive	ExposureActive	FVAL	LVAL	PulseGenerator0	PulseGenerator1	PulseGenerator2	PulseGenerator3	UserOutput0	UserOutput1	UserOutput2	UserOutput3	Line4	Line5	Line7	Line10	Nand0Out	Nand1Out	Low	High	AcquisitionTriggerWait	FrameTriggerWait
PulseGenerator0		✓	✓	✓	✓	✓	✓	✓	✓	✓	✓	✓	✓	✓	✓	✓	✓	✓	✓	✓			✓	✓
PulseGenerator1		✓	✓	✓	✓	✓	✓	✓	✓	✓	✓	✓	✓	✓	✓	✓	✓	✓	✓	✓			✓	✓
PulseGenerator2		✓	✓	✓	✓	✓	✓	✓	✓	✓	✓	✓	✓	✓	✓	✓	✓	✓	✓	✓			✓	✓
PulseGenerator3		✓	✓	✓	✓	✓	✓	✓	✓	✓	✓	✓	✓	✓	✓	✓	✓	✓	✓	✓			✓	✓

Technical notes

The Pulse Generator function – what it is and how to use it

Counter And Timer Control Function

This camera supports only the counter function.

The counter function counts up change points in the camera's internal signals using the camera's internal counter, and reads that information from the host side. This function is useful for verifying error conditions via the count value using internal camera operations. Four counters are available on the camera; Counter0, Counter1, Counter2, and Counter3. The functions that can be counted are fixed for each counter.

- Counter0 : Counts the number of FrameTrigger.
- Counter1 : Counts the number of ExposureStart.
- Counter2 : Counts the number of SensorReadOut.
- Counter3 : Counts the number of FrameTransferEnd.

When a problem occurs in a system that includes this camera, comparing the values from multiple counters allows you to verify the extent of normal operability and can be useful when investigating the cause of the problem.

■ Counter occurrence diagram

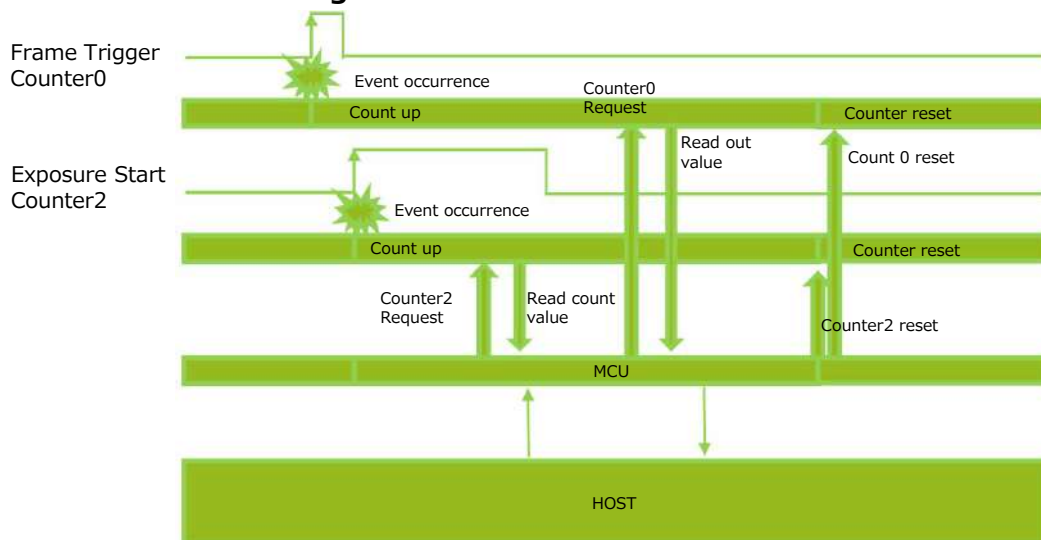

Note

You can reset a specific counter's count value by executing CounterReset[Counter0, Counter1, Counter2, Counter3].

■ Internal camera blocks

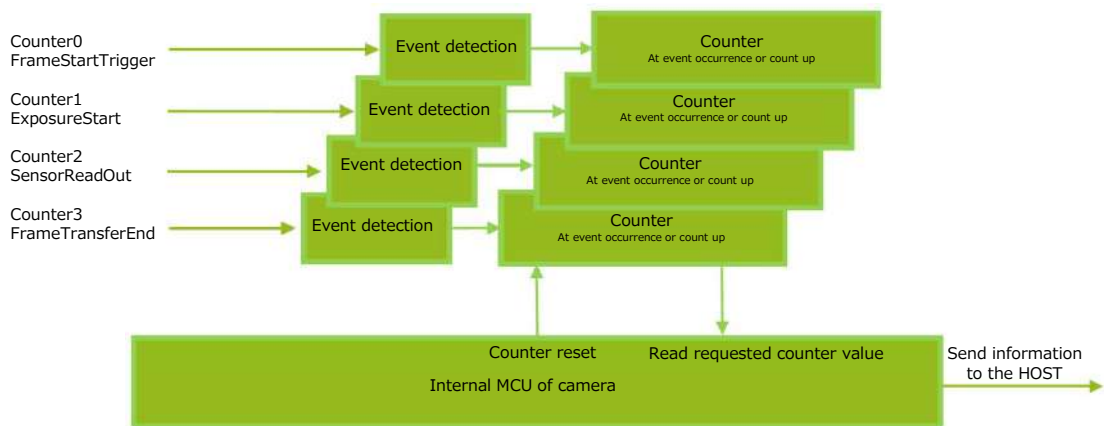

■ To use the counter function

Configure the settings as follows.

Four counters are available. Specify a counter (Counter0 to Counter3), and configure the settings.

Item	Setting value / selectable range	Description
Counter 0 ~ 3	Counter 0 ~ 3	Select the counter.
CounterEventSource	Counter0 Off, FrameStartTrigger Counter1 Off, ExposureStart Counter2 Off, SensorReadOut Counter3 Off, FrameTransferEnd	Select the counter event signal for which to read the count value. When set to Off, the counter operation will stop (but will not be reset).
CounterEventActivation	Rising Edge, Falling Edge	Specify timing at which to count. Counter0 Rising Edge Counter1 Rising Edge Counter2 Rising Edge Counter3 Falling Edge

Lens control (Transfer camera control commands)

By connecting this camera to a Birger Mount Adapter via RS-232C and transferring the lens control command sent via CoaXPress to the camera, the lens can be controlled via this camera.

This mode is enabled when [Lens Communication Enable] in [Lens Communication Control] is set to [True].

■ Connect to Birger Mount with AUX connector (10 pins)

- Pin.7 : RS-232C-Tx
- Pin.8 : RS-232C-Rx
- Pin.6 : Power supply DC9V
([Lens Communication Enable] = [True] only)
- Pin.5,9,19 : GND

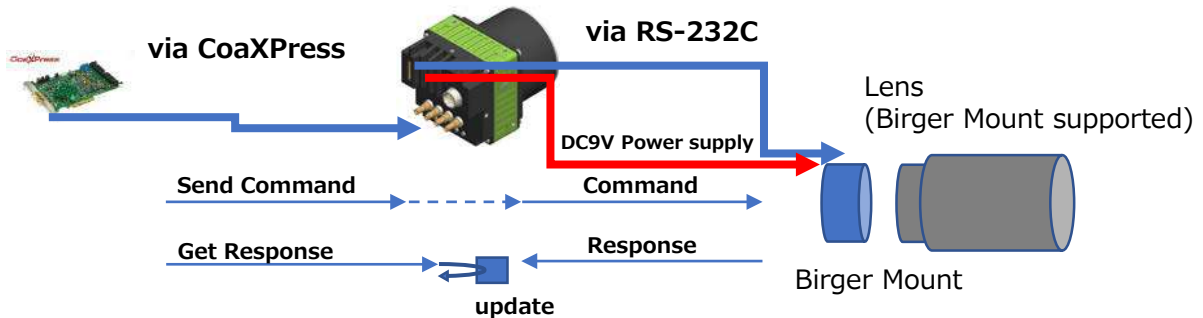

■ Communication settings between camera and Birger Mount

- [Lens Communication Baudrate] = (9600bps, 19200bps, 38400bps, 115200bps)
- [Lens Communication DataBit] = (7bit, 8bit)
- [Lens Communication Parity] = (None, Odd)
- [Lens Communication StopBit] = (1bit, 2bit)

■ Send lens control command and read Birger Mount response

- Command Send : [Lens Communication SendData]
- Get Response : [Lens Communication RecvData]
- Update Response : [Lens Communication RecvDataUpdate]

*) Refer to the Birger Mount manual for details on the send/receive commands.

 Technical notes

Selection and usage guidelines :
birger Adapter

Setting List

This camera complies with GenICam. Each setting item name conforms to GenICam SFNC (Standard Features Naming Convention). (There are some JAI-specific setting items).

Each setting item is an integer type (IInteger), a real type (IFloat), an element enumeration type (IEnumeration), a character string (IString), a logical type (IBoolean), and a category type (ICategory) or a command type (ICommand) for executing the function.

Each setting item is given permission to view and set. There are three types of authority: Beginner, Expert, and Guru.

Beginner : For beginner users.

Expert : For users with deep knowledge of camera functions.

Guru : For advanced users who make settings, including advanced features that can cause the camera to malfunction if not set correctly

■ Selector

A Selector is used to index which instance of the feature is accessed in situations where multiple instances of a feature exist.

[Instance example]

When the analog gain can be changed for each of the red, green, and blue channels in a color camera.

Analog gain is a function that has multiple instances, and red, green, and blue are the indexes.

Selectors are a feature of element enumeration type (IEnumeration) or an integer type (IInteger). However, unlike normal configuration items, it is only used to select the instance in the following configuration item.

It does not change the behavior of the camera by changing the value of the selector.

Also, the selector may have only one selectable value. In this case, use the selector function only for information purposes. In this document, it is described as SelectedFeature[Selector] according to the description method of GenICam.

In the case of analog gain given as an example of an instance, the description is as follows.

AnalogGain[Red] = 1.0

AnalogGain[Green] = 1.1

AnalogGain[Blue] = 1.2

Generally, selectors only apply to a single category of features.

(Example: TriggerSelector only applies to trigger related functions.)

Feature Properties

Item	Setting range	Default value	Description
DeviceControl			
Display/configure information related to the device.			
DeviceScanType	—	Areascan	Display the scan type.
DeviceVendorName	—	"JAI Corporation"	Display the manufacturer name.
DeviceModelName	—	SP-45001M-CXP2A	Display the model name.
DeviceManufacturerInfo	—	See the possibilities	Display the manufacturer information.
DeviceVersion	—	—	Display the hardware version.
DeviceFirmwareVersion	—	—	Display the firmware version.
DeviceFpgaVersion	—	—	Display the FPGA version.
DeviceSerialNumber	—	—	Display the device ID.
DeviceUserID	Any	—	Set the user ID (16bytes) for the camera.
DeviceTLType	3.CoaXPress (fixed)	—	Transport Layer type of the device.
DeviceTLVersionMajor	—	—	Indicates the major version number of the GenICam XML file of the selected manifest entry.
DeviceTLVersionMinor	—	—	Indicates the minor version number of the GenICam XML file of the selected manifest entry.
DeviceTLVersionSubMinor	—	—	Indicates the subminor version number of the GenICam XML file of the selected manifest entry.
DeviceMaxThroughput	—	—	Takes the following values according to the setting of CxpLinkConfiguration. (Unit : Bytes / sec) [CXP12-2] 3125000000 [CXP12-1] 1562500000 [CXP6-2] 1562500000 [CXP6-1] 781250000
DeviceStreamChannelCount	1	1	Indicates the number of streaming channels supported by the device.
DeviceStreamChannelPacketSize	—	—	—
DeviceEventChannelCount	1	1	Indicates the number of event channels supported by the device.
DeviceReset	—	—	Reset the device. (After the camera receives this command, it returns an ACK response. Then, execute reset.)
DeviceTemperatureSelector	0: Mainboard	Mainboard	Select the area of the camera's interior for which to display the temperature sensor's reading. (fixed Mainboard)
DeviceTemperature	—	—	Display the internal temperature (°C) of the camera.
Timestamp	0~9223372036854775807 (maximum value of unsigned 64-bit)	—	Display the timestamp value. Resets to 0 when the signed maximum 64-bit value is exceeded.
TimestampReset	—	—	Forcibly sets the timestamp's count value to 0.
TimestampLatch	—	—	Sets the timestamp's count value to TimestampLatchValue.
TimestampLatchValue (ns)	0~9223372036854775807 (maximum value of unsigned 64-bit)	0	—

Item	Setting range	Default value	Description
TransportLayerControl			
PlayloadSize	32~268369920	44728320	Display the payload size.
DeviceTapGeometry	—	Geometry_1X_1Y	Set the Tap Geometry. [Setting range] 0:Geometry_1X_1Y, 1:Geometry_2X_1Y, 2:Geometry_3X_1Y 3:Geometry_4X_1Y, 4:Geometry_8X_1Y
CoaXPress			
CxpLinkConfigurationPreferred			The Link configuration is returned as the combination of the Connection speed and the number of active Connections using the following format "CXPm_Xn", where m is the Connection speed and n the number of active Connections. [Link Configuration supported by this camera] CXP6_X2, CXP6_X1, CXP12_X2, CXP12_X1
CxpLinkConfiguration			Set the CoaXPress Link Configuration. [Link Configuration supported by this camera] CXP6_X2, CXP6_X1, CXP12_X2, CXP12_X1
JAI CxpLinkConfigurationPreferred			CXP6_X2, CXP6_X1, CXP12_X2, CXP12_X1
CxpLinkSharingEnable	0:False, 1:True	0:False	Enable(True)/disable(False) [CXPLinkSharing].
CxpLinkSharingSubDeviceSelector	0: Master sub-Device 1: Slave sub-Device #1 2: Slave sub-Device #2 3: Slave sub-Device #3	0: Master sub-Device	Select SubDevice.
CxpLinkSharingStatus			Display the LinkSharingStatus for SubDevice. NotReady: Stream output not ready. Ready: Ready to output stream. NotUsed: Do not use the selected Sub-Device.
CxpLinkSharingSubDeviceType	0: Master 1: Slave	0: Master	Displays the Sub-Device type of each LINK.
CxpLinkSharingHorizontalStripeCount	0 ~ 2	0	Sets the number of horizontal image divisions for divided images.
CxpLinkSharingVerticalStripeCount	0 ~ 2	0	Sets the number of vertical image divisions for divided images.
CxpLinkSharingHorizontalOverlap	0, 64, 128	0	Sets the horizontal overlap pixels of the split image.
CxpLinkSharingVerticalOverlap	0, 64, 128	0	Sets the vertical overlap lines of the split image.
CxpLinkSharingDuplicateStripe	0 ~ 2	0	Set the number of duplication.
CxpConnectionSelector			
CxpConnectionTestMode			0:Off 1:Mode1
CxpConnectionTestErrorCount			
CxpSendReceiveSelector			
CxpConnectionTestPacketCount			
CxpErrorCounterSelector			
CxpErrorCounterReset			
CxpErrorCounterValue			
CxpErrorCounterStatus			
CxpVersionUsed	—	—	Display the CXP version. 0:Not supported, 1:CXP1.0, 2:CXP1.1, 3:CXP2.0

Item	Setting range	Default value	Description
ImageFormatControl			
Configure image format settings.			
SensorWidth	8192	8192	Display the maximum image width.
SensorHeight	5460	5460	Display the maximum image height.
WidthMax	8192	8192	Display the maximum image width.
HeightMax	5460	5460	Display the maximum image height.
Width	128~8192 step 128	8192	Set the image width.
Height	8~5460 step 4	4096	Set the image height.
OffsetX	0~8064 step 128	0	Set the horizontal offset.
OffsetY	0~5452 step 4	0	Set the vertical offset.
BinningHorizontalMode	Average, Sum	Sum	Set the mode for horizontal binning.
BinningHorizontal	1,2	1	Set the number of pixels in the horizontal direction for which to perform binning.
BinningVerticalMode	Sum	Sum	Set the mode for vertical binning. (Sum fixed)
BinningVertical	1,2	1	Set the number of pixels in the vertical direction for which to perform binning.
ReverseX	0,1	0	To reverse the image horizontally, set [ReverseX] to True. In SP-45001C-CXP2A, the PixelFormat that can be set differs depending on the ReverseX and ReverseY settings. ReverseX : 0 (False) ReverseY : 0 (False) -> BayerRG ReverseX : 0 (False) ReverseY : 1 (True) -> BayerGB ReverseX : 1 (True) ReverseY : 0 (False) -> BayerGR ReverseX : 1 (True) ReverseY : 1 (True) -> BayerBG
ReverseY	0,1	0	To reverse the image vertically, set [ReverseY] to True. In SP-45001C-CXP2A, the PixelFormat that can be set differs depending on the ReverseX and ReverseY settings. Please refer to [ReverseX].
PixelFormat	—	SP-45001C-CXP2A : BayerRG8 SP-45001M-CXP2A : Mono8	Set the pixel format. In SP-45001C-CXP2A, the PixelFormat that can be set differs depending on the ReverseX settings. [Setting range] [SP-45001C-CXP2A] ReverseX : 0 (False) ReverseY : 0 (False) 0x01080009:BayerRG8, 0x0110000D:BayerRG10, 0x01100011:BayerRG12, 0x0110010A:BayerRG14 ReverseX : 0 (False) ReverseY : 1 (True) 0x0108000A:BayerGB8, 0x0110000E:BayerGB10, 0x01100012:BayerGB12, 0x0110010B:BayerGB14 ReverseX : 1 (True) ReverseY : 0 (False) 0x01080008:BayerGR8, 0x0110000C:BayerGR10, 0x01100010:BayerGR12, 0x01100109:BayerGR14 ReverseX : 1 (True) ReverseY : 1 (True) 0x0108000B:BayerBG8, 0x0110000F:BayerBG10, 0x01100013:BayerBG12, 0x0110010C:BayerBG14 [SP-45001M-CXP2A] 0x01080001:Mono8, 0x01100003:Mono10, 0x01100005:Mono12
TestPattern	—	Off	Select the test image. [Setting range] 0:Off 1:GreyHorizontalRamp 2:GreyVerticalRamp 3:GreyHorizontalRampMoving SP-45001C-CXP2A only 4:HorizontalColorBar 5:VerticalColorBar 6:HorizontalColorBarMoving
OverlayMode	0:Off 1:MultiRoiAreaMode 2:ALCAreaMode 3:AWBAreaMode	0:Off	You can check the target area by reducing the brightness of the non-target area to 50%. MultiRoiAreaMode : Check the active area on MultiROI. ALCAreaMode: Check the photometry area on ALC. AWBAreaMode: Check the photometry area on AWB.
MultiROIControl			
Configure settings for Multi ROI.			
MultiRoiMode	0: Off, 1: On	Off	Enable/disable Multi Roi.
MultiRoiIndex	0 ~ 7		Select the index for the Multi Roi mode.
MultiRoiWidth	—	—	Set the width for the selected Multi Roi index.
MultiRoiHeight	—	—	Set the height for the selected Multi Roi index.
MultiRoiOffsetX	—	—	Set the horizontal offset for the selected Multi Roi index.
MultiRoiOffsetY	—	—	Set the vertical offset for the selected Multi Roi index.
MultiRoiHorizontalEnableNumber	1 ~ 8	—	Set the maximum number of valid horizontal index numbers.
MultiRoiVerticalEnableNumber	1 ~ 8	—	Set the maximum number of valid vertical index numbers.

Item	Setting range	Default value	Description
AcquisitionControl			
AcquisitionMode	0:SingleFrame, 1:MultiFrame, 2:Continuous	Countinuous	Select the image capture mode.
AcquisitionStart	—	—	Start image capture.
AcquisitionStop	—	—	Stop image capture.
AcquisitionFrameCount	1~65535	1	In [MultiFrame] mode, set the number of frames to capture.
AcquisitionFrameRate	0.125~		Display the frame rate as a frequency. (unit: Hz) The maximum value varies depending on the PixelFormat setting and the ROI setting.
TriggerSelector	0:AcquisitionStart, 1:AcquisitionEnd, 3:FrameStart	AcquisitionStart	Select the trigger operation.
TriggerMode	0:Off, 1:On	Off	Select the trigger mode.
TriggerSoftware	—	—	Execute the software trigger.
TriggerSource	—	—	Select the trigger signal source. [Setting range] 7: PulseGenerator0, 8: PulseGenerator1, 9: PulseGenerator2 10: PulseGenerator3, 11: UserOutput0, 12: UserOutput1 13: UserOutput2, 14: UserOutput3, 19: Software, 23: Line4, 24: Line5 26: Line7, 29: Line10, 36: Nand0Out 37: Nand1Out
TriggerActivation	1:RisingEdge 2:FallingEdge 3:LevelHigh 4:LevelLow	RisingEdge	Select the polarity of the trigger signal (i.e., location of signal at which trigger is applied).
TriggerOverlap	1:ReadOut	ReadOut	Select the trigger overlap operation. (ReadOut fixed)
TriggerDelay	0~500000	0	Set the time of exposure start from trigger input. (unit: μ s)
ExposureMode	0: Off, 1: Timed, 2: TriggerWidth	Timed	Select the exposure mode.
ExposureTime	60 μ s ~	—	Set the exposure time. (μ s) The specifiable range varies depending on the operation modes and CXP setting. The actual exposure time is the set value minus the image sensor offset.
ExposureAuto	0: Off, 1: Once, 2: Continuous	Off	Set whether to enable auto exposure.

Item	Setting range	Default value	Description
DigitalIOcontrol			
Configure settings for digital input/output.			
LineSelector	—	Line1	Select the input/output to configure. [Setting range] 20:Line1 TTL Out1, 21:Line2 Opt Out1, 23:Line4 TTL In1 24:Line5 Opt In1, 26:Line7 Cxp In, 27:Line8 TTL Out2 29:Line10 TTL In2, 60:Nand0 In1, 61:Nand0 In2 62:Nand1 In1, 63:Nand1 In2, 255:TimestampReset
LineMode	0: Input, 1: Output, 2: InternalConnection	—	Display the input/output status (whether it is input or output).
LineInverter	True, False	False	Display the status of the input signal or output signal (True: High, False: Low).
LineStatus	True, False	—	Display the status of the input signal or output signal (True: High, False: Low).
LineStatusAll	—	—	Display the input/output signal status. The state is shown with 16 bits. Bit assignments are as follows. bit0:Line1, bit1:Line2, bit2: -, bit3:Line4, bit4:Line5 bit5: -, bit6:Line7, bit7:Line8, bit8: -, bit9:Line10 bit10 ~ bit15: -
LineSource	—	—	Select the line source signal for the item selected in [Line Selector]. [Setting range] 0:Off (LineSelector=TimestampReset only) 1:AcquisitionActive 2:FrameActive 4:ExposureActive 5:FVAL 6:LVAL 7-10:PulseGenerator0-3 11-14:UserOutput0-3 23:Line4 TTL In1 24:Line5 Opt In1 26:Line7 Cxp In 29:Line10 TTL In2 36:Nand0 Out 37:Nand1 Out 40:- (Not selectable for Output) 41:Low 42:High 43: AcquisitionTriggerWait 44: FrameTriggerWait ※LineSelector=23,24,26,29 are "-" (fixed) [Default] LineSelector=255:Off(0) LineSelector=255 except :Line4 TTL In1(23)
LineFormat	—	—	Display the signal format. 2:TTL 5:OptoCoupled 7:Internal Signal [Default] LineSelector=21,24:OptoCoupled LineSelector=26,60,61,62,63,255:Internal Signal Other:TTL
OptInFilter	0~10000000	0	Select the filter to remove noise from the OptIn input signal of Digital I/O. [0(Default)~10000000(10ms)]
UserOutputSelector	0: UserOutput0 1: UserOutput1 2: UserOutput2 3: UserOutput3	UserOutput0	Set the UserOutput signal.
UserOutputValue	True, False	False	Set the value for the UserOutput selected in [UserOutputSelector].

Item	Setting range	Default value	Description
m) PulseGenerator			
Configure pulse generator settings.			
ClockPreScaler	1~4096	5.4	Set the division value for the prescaler (12 bit) using PixelClock as the base clock.
PulseGeneratorClock (MHz)	0.0181274~74.25	0.6	Set the clock used for the pulse generator. This value is calculated using the [ClockPreScaler] value as a base.
PulseGeneratorSelector	0: PulseGenerator0, 1: PulseGenerator1, 2: PulseGenerator2, 3: PulseGenerator3	PulseGenerator0	Select the pulse generator. [setting range] 0: PulseGenerator0, 1: PulseGenerator1, 2: PulseGenerator2, 3: PulseGenerator3
PulseGeneratorLength	1~1048575	30000	Set the maximum count-up value as a clock count.
PulseGeneratorLengthMs	1 / PulseGeneratorClock (MHz) ~1048575 / PulseGeneratorClock (MHz)	50	Set the maximum count-up value in milliseconds. This value is calculated using the [PulseGeneratorLength] value as a base. The setting range varies depending on the [ClockPreScaler] value.
PulseGeneratorFrequency	PulseGeneratorClock (MHz) ÷ 1048575 × 1000000 ~ PulseGeneratorClock (MHz) × 1000000	20	Set the maximum count-up value as a frequency. This value is calculated using the [PulseGeneratorLength] value as a base.
PulseGeneratorStartPoint	0 ~ 1048574	0	Set the start point of the High interval as a clock count. When the counter reaches this value, the output will be 1.
PulseGeneratorStartPointMs	0 ~ 1048575 / PulseGeneratorClock (MHz)	0	Set the start point of the High interval in milliseconds. When the counter reaches this value, the output will be 1. The setting range varies depending on the [ClockPreScaler] value.
PulseGeneratorEndPoint	1 ~ 1048575	15000	Set the start point of the Low interval as a clock count. When the counter reaches this value, the output will be 0.
PulseGeneratorEndPointMs	1 / PulseGeneratorClock (MHz) ~ 1048575 / PulseGeneratorClock (MHz)	25	Set the start point of the Low interval in milliseconds. When the counter reaches this value, the output will be 0. The setting range varies depending on the [ClockPreScaler] value.
PulseGeneratorPulseWidth	—	25	Display the High interval width of the pulse in milliseconds. The duration between the Start Point and End Point is calculated. The setting range varies depending on the [ClockPreScaler] value.
PulseGeneratorRepeatCount	0 ~ 255	0	Set the repeat count for the counter. When this is set to [0], a free counter is enabled with no repeat limit.
PulseGeneratorClearActivation	0: Off, 1: RisingEdge, 2: FallingEdge, 3: LevelHigh, 4: LevelLow	Off	Set the clear signal condition for the count clear input of the pulse generator. [setting range] 0: Off, 1: RisingEdge, 2: FallingEdge, 3: LevelHigh, 4: LevelLow
PulseGeneratorClearSource	—	—	Set the clear signal condition for the count clear input of the pulse generator. [setting range] refer to "Pulse Generator".
PulseGeneratorClearSyncMode	0: AsyncMode, 1: SyncMode	AsyncMode	Select the sync mode for the count clear input signal.

Item	Setting range	Default value	Description
AnalogControl			
Configure analog control settings.			
GainSelector	0:DigitalAll, 1:DigitalRed, 2:DigitalBlue	DigitalAll	Select the gain to configure. (DigitalRed, DigitalBlue are available for SP-45001C-CXP2A only)
Gain	DigitalAll x1.0 ~ x16.0 DigitalRed x0.447~x5.624 DigitalBlue x0.447~x5.624	DigitalAll, x1.0 DigitalRed, x1.0 DigitalBlue, x1.0	Set the gain value for the gain setting selected in [GainSelector]. (DigitalRed, DigitalBlue are available for SP-45001C-CXP2A only)
GainAuto	0:Off, 1:Once, 2:Continuous	Off	Enable/disable gain auto adjustment. [Once] automatically changes to [Off] when the signal level converges once.
AnalogBaseGain	0:0dB, 1:6dB, 2:12dB	0dB	Set the AnalogBaseGain.
BlackLevelSelector	0:All, 1:Red, 3:Blue	All	Select the black level to configure. (Red, Blue are available for SP-45001C-CXP2A only)
BlackLevel	All, -133~255 Red, -64~ 64 Blue -64~ 64	All, 0 Red, 0 Blue 0	Set the black level value. (Red, Blue are available for SP-45001C-CXP2A only)
BalanceWhiteAuto	0:Off, 1:Once, 2:Continuous, 3:Preset4000K, 4:Preset4600K, 5:Preset5600K, 6:Preset6500K, 7:Preset7500K	Off	Enable/disable auto white balance. (SP-45001C-CXP2A only)
AWBAreaSelector	—	—	Select the area for which to configure [AWBAreaEnable]. (SP-45001C-CXP2A only) [Setting range] 15:HighLeft, 14:HighMidLeft, 13:HighMidRight, 12:HighRight, 11:MidHighLeft, 10:MidHighMidLeft, 9:MidHighMidRight, 8:MidHighRight, 7:MidLowLeft, 6:MidLowMidLeft, 5:MidLowMidRight, 4:MidLowRight, 3:LowLeft, 2:LowMidLeft, 1:LowMidRight, 0:LowRight
AWBAreaEnable	True, False		Enable/disable the photometry area selected in [AWBAreaSelector].
AWBAreaEnableAll	True, False		True: Operate BalanceWhiteAuto with all areas designated as photometry areas, regardless of the individual enabled/disabled photometry area states configured in [AWBAreaSelector]. False: Operate BalanceWhiteAuto according to the individual enabled/disabled photometry area states configured in [AWBAreaSelector].
AWBControlSpeed	1 to 8	4	Set the response speed for BalanceWhiteAuto. (8 is the fastest) Estimated time to convergence 1: 8sec, 2: 4sec, 3: 3sec, 4: 2sec, 5: 1.5sec, 6: 1sec, 7: 0.75sec, 8: 0.5sec
BalanceWhiteAutoResult	—	—	Display the results of BalanceWhiteAuto. 0: Idle (Balance White Auto is not executed yet.) 1: Processing (Balance White Auto is processing.) 2: Converging (Balance White Auto is converging.) 3:Succeeded (Balance White Auto was Succeeded.) 4: Error1 (G image was too bright) 5: Error2 (G image was too dark) 6: Error3 (Timeout error has occurred. Please try again.) 7: Error4 (Could not process.) 8: Error5 (R or B image was out of range.)
Gamma	0.45, 0.5, 0.55, 0.6, 0.65, 0.75, 0.8, 0.9, 1.0	0.45	Set the gamma value.
LUTMode	0:Off, 1:Gamma, 2:LUT	Off	Select the LUT mode.
g) LUTControl			
Configure LUT settings.			
LUTSelector	0:Red 1:Green 2:Blue	Red	Select the LUT channel to control.
LUTIndex	0~256	0	Set the LUT index table number.
LUTValue	0~4095	Gamma=1.0	Set the LUT value.

Item	Setting range	Default value	Description
AutoLevelControl			
Configure AutoLevelControl.			
ALCReference	30 ~ 95	50	Set the target level for ALC. (unit: %)
ALCAreaSelector	—	—	Select the area for which to configure [ALCAreaEnable]. [Setting range] 15:HighLeft, 14:HighMidLeft, 13:HighMidRight, 12:HighRight, 11:MidHighLeft, 10:MidHighMidLeft, 9:MidHighMidRight, 8:MidHighRight, 7:MidLowLeft, 6:MidLowMidLeft, 5:MidLowMidRight, 4:MidLowRight, 3:LowLeft, 2:LowMidLeft, 1:LowMidRight, 0:LowRight
ALCAreaEnable	True, False	True	Enable/disable the photometry area selected in [ALCAreaSelector].
ALCAreaEnableAll	True, False	True	True: Operate ALC with all areas designated as photometry areas, regardless of the individual enabled/disabled photometry area states configured in [ALCAreaSelector]. False: Operate ALC according to the individual enabled/disabled photometry area states configured in [ALCAreaSelector].
ALCControlSpeed	1 ~ 8	4	Set the response speed for ALC. (8 is the fastest.) Estimated time to convergence 1: 8sec, 2: 4sec, 3: 3sec, 4: 2sec, 5: 1.5sec, 6: 1sec, 7: 0.75sec, 8: 0.5sec
AutoControlStatus	—	Idle	You can check the convergence operation status of AGC, ASC, and AWB.
ExposureAutoControlMin	100 ~	—	Set the minimum value for the ExposureTime control range
ExposureAutoControlMax	101 ~	—	Set the maximum value for the ExposureTime control range
GainAutoControlMin	1 ~ 15	1	Set the minimum value for the GainAuto control range
GainAutoControlMax	2 ~ 16	16	Set the maximum value for the GainAuto control range
Imaging Control			
VideoProcessBypassMode	0:Off, 1:On	Off	Enable/disable VideoProcessBypass mode.
HDRMode	0:Off, 1:Linear, 2:knee	50	When Linear is set, PixelFormat is fixed at 14 bits. AnalogBaseGain cannot be set when HDRMode is Linear or Knee.
HDRKneePoint	0~4095	0	Knee is set : Set the value in the range of 0 to 4095 with 12-bit.
HDRKneeSlope	0.01~1	1	Knee is set : Set the tilt (vertical ÷ horizontal).
FrameIntegrationMode	0:Off, 1:Frame, 2:Exposure		FrameIntegrationMode has two modes: Frame and Exposure. Frame: Captures the specified number of frames (FrameIntegrationFrameNumber) and outputs a 1-frame image of the addition average result. Exposure: Takes 2 frames of images with different exposure times and outputs 1 frame of the result of addition. (Exposure time are set by FrameIntegrationExposure1, FrameIntegrationExposure2) Both the Frame and Exposure modes can be set only when HDRMode is Off.
FrameIntegrationFrameNumber	2~8		
FrameIntegrationExposure1	40~8000000		
FrameIntegrationExposure2	40~8000000		
EdgeEnhancer			
EdgeEnhancerEnable	True, False	False	Enable/disable EdgeEnhancer. (SP-45001M-CXP2A only)
EdgeEnhancerLevel	0:Low, 1:Middle, 2:High, 3:Strong	Middle	Set the Level for EdgeEnhancer. (SP-45001M-CXP2A only)

Item	Setting range	Default value	Description
Shading			
Configure shading correction settings.			
ShadingCorrectionMode	0: FlatShading, 1: ColorShading	FlatShading	Select the shading correction method.
ShadingMode	0: Off, 1: User1, 2: User2, 3: User3	Off	Set the area to which to save shading correction data. When this is set to [Off], shading correction data is not saved.
PerformShadingCalibration	—	—	Execute shading correction. This command cannot be executed under the following conditions. · When no image is output. · Outputting TestPattern. · When the ROI setting is under the following conditions. (Width or Height are less than 128) · Shading Mode is Off.
ShadingDetectResult	—	—	Display the shading correction results. 0: Idle 1: Succeeded (Shading calibration was Succeeded.) 2: Error1 (Image was too bright.) 3: Error2 (Image was too dark.) 4: Error3 (Could not calibrated.) 5: Error4 (Correction Limit.)
BlemishControl			
Configure settings for JA1 white blemish correction.			
BlemishEnable	True, False	True	Enable/disable blemish correction.
BlemishDetect	—	—	Execute blemish detection. This command can not be executed under the following conditions. · When no image is output · Outputting TestPattern · In Sequencer mode · In MultiRoi mode · In single ROI mode
BlemishDetectThreshold	1 ~ 99	10	Set the blemish detection threshold.
BlemishStore	—	—	Stores the Blemish data that to be entered by
BlemishCompensationIndex	1 ~ 1000	1	Select the index for the target blemish coordinates (BlemishDataPosition X/Y).
BlemishCompensationPositionX	-1 ~ 8191	—	Display the X coordinate (horizontal pixel position) of the target blemish selected in [BlemishCompensationIndex]. You can also manually enter the X coordinate of the blemish you want to correct.
BlemishCompensationPositionY	-1 ~ 5439	—	Display the Y coordinate (vertical pixel position) of the target blemish selected in [BlemishCompensationIndex]. You can also manually enter the Y coordinate of the blemish you want to correct.
BlemishCompensationDataClear	—	—	Delete detected or specified blemish information selected in
BlemishCompensationNumber	0 ~ 3183	0	Display the number of target blemishes.

Item	Setting range	Default value	Description
SequencerControl			
Configure sequencer settings.			
SequencerMode	Off, On	Off	Enable/disable [SequencerMode].
SequencerModeSelect	0:TriggerSequencerMode, 1:CommandSequencerMode	TriggerSequencerMode	Select the sequencer mode.
SequencerSetSelector	1~128	1	Select the index number to configure.
SequencerWidth	128~8192 step 128	8192	Set the width of the selected SequencerIndex.
SequencerHeight	8~4096 step 4	4096	Set the height of the selected SequencerIndex.
SequencerOffsetX	0~8064 step 128	0	Set the horizontal offset value for the selected SequencerIndex.
SequencerOffsetY	0~4092 step 4	0	Set the vertical offset value for the selected SequencerIndex.
SequencerBinningHorizontal	0, 1	0	For the selected SequencerIndex, set the number of pixels in the horizontal direction for which to perform binning. In binning mode, the setting value of BinningHorizontalMode is applied.
SequencerBinningVertical	0, 1	0	For the selected SequencerIndex, set the number of pixels in the vertical direction for which to perform binning. In binning mode, the setting of BinningVerticalMode is applied.
SequencerFrameCount	—	—	Set the FrameCount value for the selected SequencerIndex.
SequencerExposureTime	1 μ s ~	—	Set the exposure time for the selected SequencerIndex.
SequencerGainDigitalAll	x1.0 ~ x16.0	x1.0	Set the GainDigitalAll value for the selected SequencerIndex.
SequencerGainDigitalRed	x0.447~x5.624	x1.0	Set the DigitalRed Gain value for the selected SequencerIndex.
SequencerGainDigitalBlue	x0.447~x5.624	x1.0	Set the DigitalBlue Gain value for the selected SequencerIndex.
SequencerBlackLevelAll	-133~255	0	Set the BlackLevelAll value for the selected SequencerIndex.
SequencerLutEnable	True, False	False	Set the LutEnable value for the selected SequencerIndex.
SequencerSetNext	0 ~ 128		Set the next index to be displayed for the selected SequencerIndex. (Enabled only for TriggerSequencer.) If 0 is specified, the operation of Sequencer is stopped.
SequencerRepetition	1~255	1	Set the repeat count for the sequencer.
SequencerSetActive	1~128	1	Displays the sequencer set number.
SequencerSetStart	1~128	1	Specify the first index number to switch to when starting [TriggerSequencerMode].
SequencerCommandIndex	1~128	1	Set this to change the SequencerIndex. (Enabled only for CommandSequencer.)
SequencerReset	—	—	In [TriggerSequencerMode], reset the current index number to the number configured in [SequencerSetStart].
CounterAndTimerControl			
Configure counter settings. (This camera only supports counter functions.)			
CounterSelector	—	—	Select the counter [Setting range] 0:Counter0, 1:Counter1, 2:Counter2, 3:Counter3
CounterEventSource	—	Off	Assign the counter event signal for which you want to read the count value to a dedicated counter, and read the value. [Setting range] Counter0 0:Off, 1:FrameTrigger Counter1 0:Off, 1:ExposureStart Counter2 0:Off, 1:SensorReadOut Counter3 0:Off, 1:FrameTransferEnd
CounterEventActivation	—	—	Set the count timing. The setting value is fixed with the following data. Counter0, Counter1, Counter2 : RisingEdge Counter3 : FallingEdge
CounterReset	—	—	Reset the counter.
CounterValue	0~65535	0	Display the count value.
CounterStatus	—	—	Display the counter status. 0: CounterIdle: Idle 1: CounterTriggerWait 2: CounterActive: Counting 3: CounterCompleted:Complete counting 4: CounterOverflow: Count value exceeded the maximum value.
UserSetControl			
Configure user settings.			
UserSetSelector	0: Default, 1: UserSet1, 2: UserSet2, 3: UserSet3	Default	Select the user settings.
UserSetLoad	—	—	Load user settings. (If 0 is specified, the factory default setting is read.)
UserSetSave	—	—	Save the current setting values as user settings. (If 0 is specified, UserSetSave is invalid.)

Item	Setting range	Default value	Description
LensCommunicationControl			
Configure settings for Lens Communication Control.			
LensCommunicationEnable	0, 1	0	Enable RS-232C for lens control.
LensCommunicationBaudrate	—	115200bps	Set the baud rate during communication. [Setting range] 0:9600bps, 1:19200bps, 2:38400bps, 3:57600bps, 4:115200bps
LensCommunicationDataBit	0:7bit 1:8bit		Set the data length during communication.
LensCommunicationParity	0:None 1:Odd 2:Even		Set the presence or absence of parity bit during communication.
LensCommunicationStopBit	0:1bit 1:2bit		Set the stop bit during communication.
LensCommunicationRecvDataUpdate			Update LensCommunicationRecvData
LensCommunicationRecvData			Displays data received from the lens to be controlled.
LensCommunicationSendData			Transfers commands to the lens to be controlled.
EventControl			
Configure settings for Event Control.			
Notes:			
- This function can only be used with CXP 2.0 or later.			
- Please contact the FG board vendor for the status of the tool's Event function support.			
EventSelector	—	0:AcquisitionStart	Select the event to send the event message. [Setting Range] 0:AcquisitionStart, 1:AcquisitionEnd, 6:ExposureStart, 7:ExposureEnd, 22:Error
EventNotification	Off, On	Off	Sets whether or not to send an event message when an event selected by EventSelector occurs.
EventAcquisitionStartData	—	—	When the event AcquisitionStart occurs, the following two data can be checked.
EventAcquisitionStart	—	—	Displays the EventID(0x0102).
EventAcquisitionStartTimestamp	—	—	Displays the Timestamp value when an event occurs.
EventAcquisitionEndData	—	—	When the event AcquisitionEnd occurs, the following two data can be checked.
EventAcquisitionEnd	—	—	Displays the EventID(0x0103).
EventAcquisitionEndTimestamp	—	—	Displays the Timestamp value when an event occurs.
EventExposureStartData	—	—	When the event ExposureStart occurs, the following two data can be checked.
EventExposureStart	—	—	Displays the EventID(0x0132).
EventExposureStartTimestamp	—	—	Displays the Timestamp value when an event occurs.
EventExposureEndData	—	—	When the event ExposureEnd occurs, the following two data can be checked.
EventExposureEnd	—	—	Displays the EventID(0x0133).
EventExposureEndTimestamp	—	—	Displays the Timestamp value when an event occurs.
EventErrorData	—	—	When the event Error occurs, the following three data can be checked.
EventError	—	—	Displays the EventID(0x01FF).
EventErrorTimestamp	—	—	Displays the Timestamp value when an event occurs.
EventErrorCode	—	0 : No Error	Displays the event error code. 0: No error. -1: EventAck no response error. This message is displayed when the EventAck from the host for each event issued cannot be obtained within the timeout value (200ms).

Miscellaneous

Troubleshooting

Check the following before requesting help. If the problem persists, contact your local JAI distributor.

■ Power supply and connections

Problem	Cause and solution
The POWER/TRIG LED remains lit amber and does not turn green, even after power is supplied to the camera.	Camera initialization may not be complete due to lack of a network connection. Check the 12-pin power cable connection.

■ Image display

Problem	Cause and solution
Gradation in dark areas is not noticeable.	Use the gamma function to correct the display. As the light-emitting properties of the monitor are not linear, the entire image may be darker or the gradation in the dark areas may be less noticeable when camera outputs are displayed without processing. Using the gamma function performs correction to produce a display that is close to linear. For details, see "Gamma Function".

■ Settings and operations

Problem	Cause and solution
Settings cannot be saved to user memory.	You cannot save to user memory while images are being acquired by the camera. Stop image acquisition before performing the save operation.
I want to restore the factory default settings.	Load [Default] under [User Set Selector] in the [Feature Properties] tab to restore the factory default settings.

Specifications

Item		SP-45001MC-CXP2A	
Scanning system		Progressive scan	
Synchronization		Internal	
Interface		CoaXPress v2.0/v1.1	
Image sensor		SP-45001C-CXP2A Bayer color CMOS SP-45001M-CXP2A Monochrome CMOS	
Image size (effective image)		Super 35mm 31.5mm(diagonal)	
Pixel size		3.2 μm (H) x 3.2 μm(V)	
Effective image pixels		8192(H) x 5460(V)	
Acquisition Frame Rate (max)	8bit	Mono8 BayerRG8	38 fps
Video Dark S/N ratio		SP-45001M-CXP2A 58dB or more (When 10bit, Gain=0dB, FrameRate=43.85fps, ExposureMode=Off) SP-45001C-CXP2A Gch 54dB or more (When 10bit, Gain=0dB, FrameRate=43.85fps, ExposureMode=Off)	
Digital image output format	ROI	Full	8192(H) x 5460(V)
		Width	128 ~ 8192 pixels 128 pixels/step
		Offset X	0 ~ 8064 pixels 128 pixels/step
		Height	8 ~ 5460 lines 4 lines/step
		Offset Y	0 ~ 5452 lines 4 lines/step
	Binning (H)	1	8192(H)
		2	5460(H)
	Binning (V)	1	4096(V)
		2	2730(V)
	Pixel Format		SP-45001C-CXP2A BayerRG8, BayerRG10, BayerRG12, BayerRG14 BayerGB8, BayerGB10, BayerGB12, BayerGB14 BayerGR8, BayerGR10, BayerGR12, BayerGR14 BayerBG8, BayerBG10, BayerBG12, BayerBG14 SP-45001M-CXP2A Mono8, Mono10, Mono12, Mono14
Acquisition Mode		Continuous / SingleFrame / MultiFrame (1 ~ 65535)	
Trigger Selector	Acquisition	AcquisitionStart / AcquisitionEnd	
	Exposure	FrameStart	
Opto filter		0(Default)~10000000(10ms)	
Trigger overlap		Available	
Trigger input signals		Software, PulseGenerator0-3, UserOutput0-3, Line4-TTL In 1, Line5-Opto in 1, Line7, Line10-TTL In 2, NAND 0 Out, NAND 1 Out	
Exposure Mode	Timed	90 μs* (min) ~ 8 s (max) ❖ Performance verified for up to 1 second.	
	Trigger Width	90 μs* (min) ~ ∞ s (max) ❖ Performance verified for up to 1 second.	
Exposure Auto		Off / Continuous / Once	
Auto exposure response speed (AGC/ASC Control Speed)		1 ~ 8	
Video send mode		NormalMode, TriggerSequencerMode, CommandSequencerMode, MultiRoiMode	
Digital /O		LineSelector (DC IN/TRIG connector (12-pin round), AUX connector (10-pin)) : GPIO IN / GPIO OUT	

*) Refer to Exposure Mode section for details.

Black Level adjustment	Default level		8LSB@8bit
	Video level adjustment range		DigitalAll : -133 ~ +255 LSB @12bit DigitalRed : -64 ~ +64 LSB @12bit DigitalBlue : -64 ~ +64 LSB @12bit
	Resolution adjustment		1LSB@12bit
Gain adjustment	Manual adjustment range		AnalogAll : 0dB ~ 24dB DigitalRed : -7dB ~ 15dB DigitalBlue : -7dB ~ 15dB
	adjustment Auto gain		Off, Continuous, Once
White balance	WhiteBalanceGain		DigitalRed, DigitalBlue : -7dB ~ 15dB
	BalanceWhiteAuto		Off, Continuous, Once, Preset4000K, Preset4600K, Preset5600K, Preset6500K, Preset7500K
	Photometry area		16 (4 x 4) Area
	Adjustment range		3000K ~ 9000K
Blemish correction	Detection		Detect white blemishes using threshold values (100 steps available) (black blemish correction performed only at factory)
	Correction		Interpolation using adjacent pixels (continuous blemishes not corrected)
	Correctable pixels		3183 pixels
ALC			Can be adjusted automatically together with AGC and ASC
Gamma			0.45、0.5、0.55、0.6、0.65、0.75、0.8、0.9、1.0 (9 steps available)
LUT			OFF : $\gamma = 1.0$ 、ON = 257 points can be set
Heatbeat			Only supported on CXP2.0 or later (CoaXPress standard V2.0). Issued from the device (camera) to the host (PC). Interval time fixed at 10ms.
Vibration resistance			10G (20 Hz ~ 200 Hz X-Y-Z direction)
Impact resistance			80G
Power supply	12-pin connector	Input range	DC + 10 V ~ + 25 V (Via input terminal)
		Consumption	9.9 W (typ.) (at 12 V input, default setting, 25 °C environment) 13.0 W (max.)
	PoCXP	Input range	DC + 24 V
		Consumption	9.9 W (typ.) (at 12 V input, default setting, 25 °C environment) 13.0 W (max.)
Lents mount			F-mount
Flange back			F-mount 46.5mm, tolerance 0 mm ~ -0.05 mm
Optical filter			IR cut filter (SP-45000C-CXP4A only)
Verified performance temperature / humidity			- 5°C ~ + 45°C / 20% ~ 80% (non-condensing) (* It may change depending on the installation environment. Please refer to the Caution.)
Storage temperature / humidity			- 25°C ~ + 60°C / 20% ~ 80% (non-condensing)
Regulations			CE(EN 55032:2015, EN 55035:2017), FCC part 15 class B, RoHS, WEEE
Dimensions (housing)			62 × 62 × 84.2 mm (W×H×D) (excluding mount protrusions)
Weight			330g(F-mount)

Package contents

Camera
body (1)
Sensor protection cap (1)
Dear Customer (sheet) (1)

Optional accessories (not supplied)

MP-42 tripod mount

Design and specifications are subject to change without notice.

Approximately 30 minutes of warm-up are required to achieve these specifications.

Caution

About the verified performance temperature, make sure the following temperature condition is met when operating the unit.

1) The camera's internal temperature should not exceed 98.8°C during operation.

If the above temperature conditions are exceeded, take measures to dissipate heat according to your installation environment and conditions.

Spectral Response

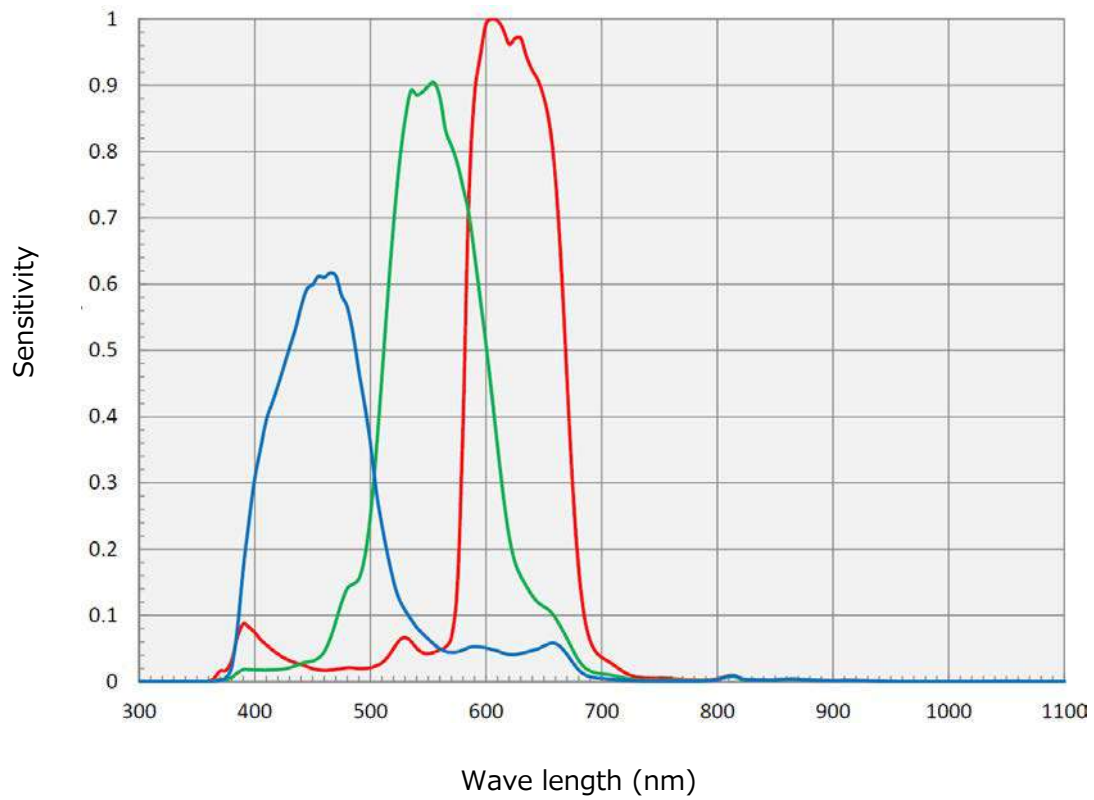
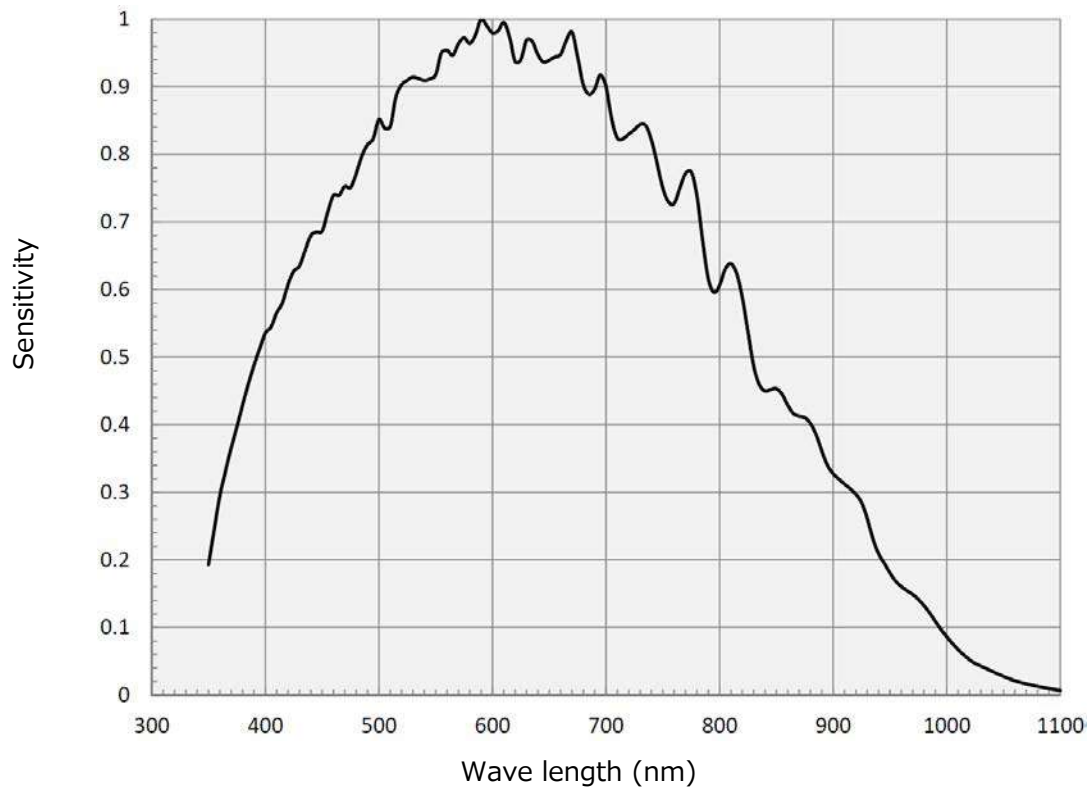
SP-45001C-CXP2A**SP-45001M-CXP2A**

Dimensions

F-mount

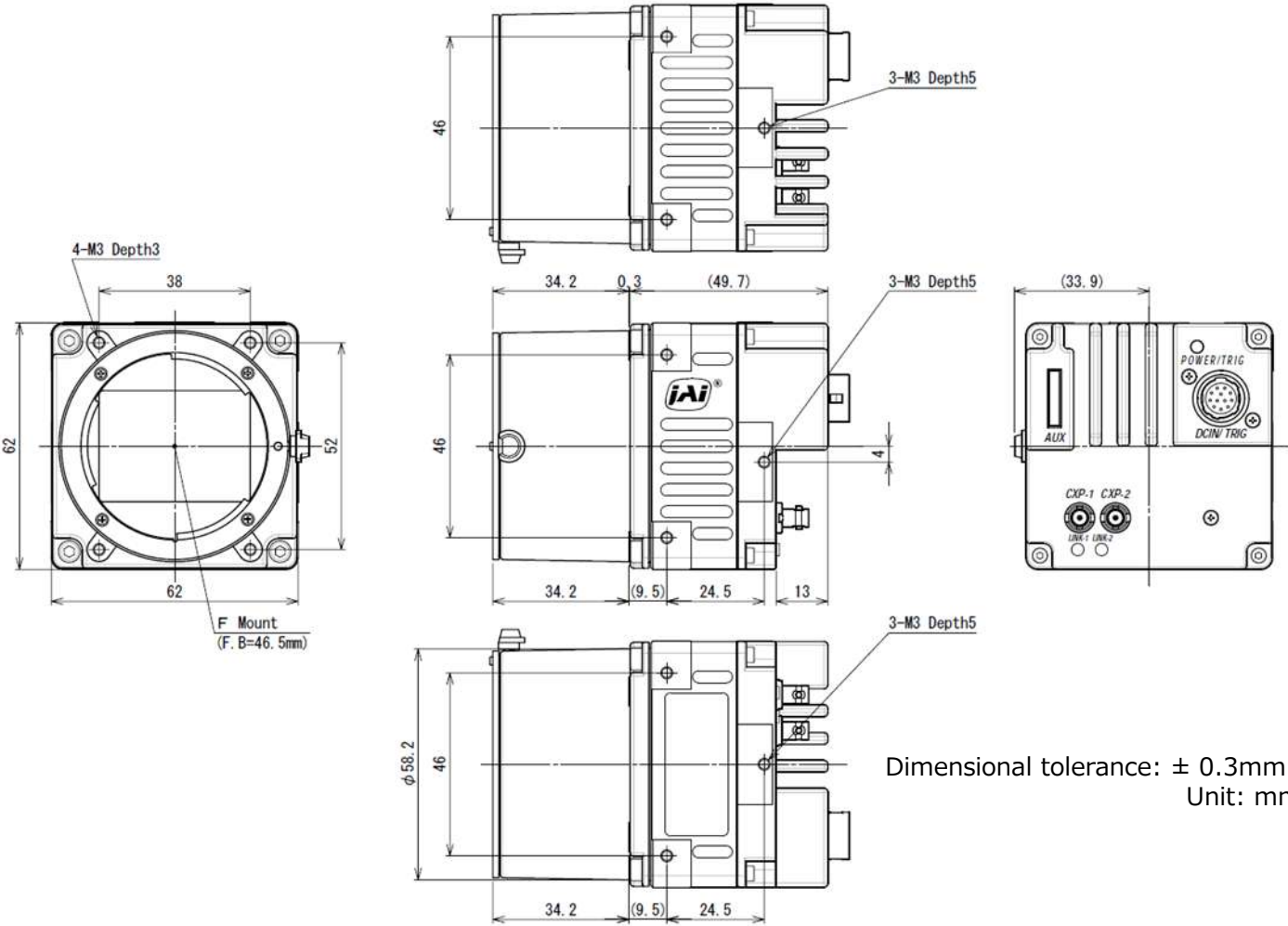

Dimensions

HS-01

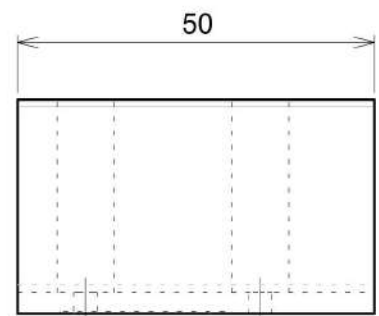
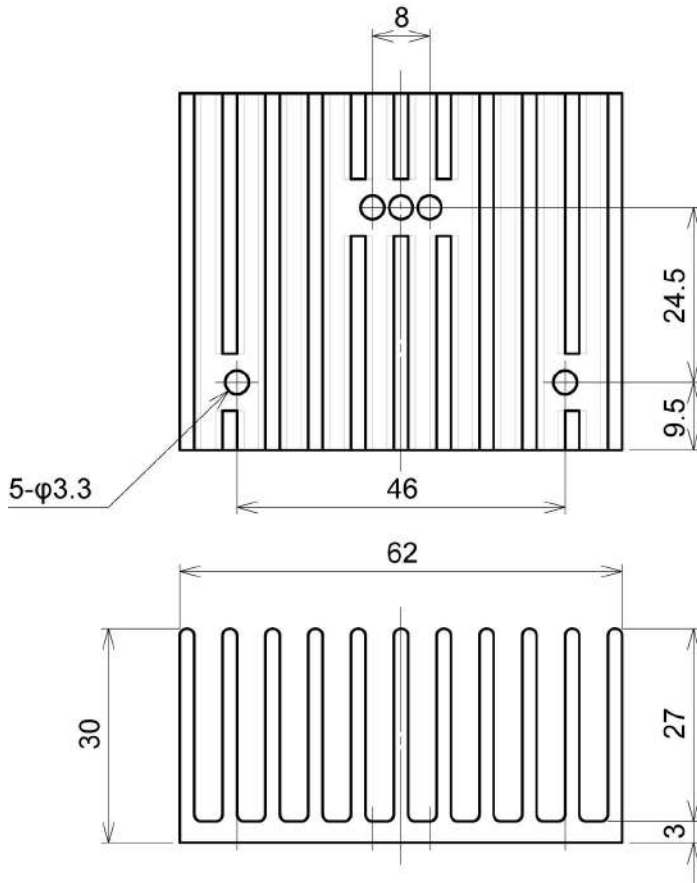

Dimensional tolerance: $\pm 0.3\text{mm}$
Unit: mm

Dimensions

HS-01 with SP-45001-CXP2A (F-Mount)

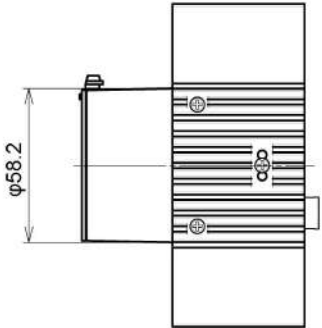
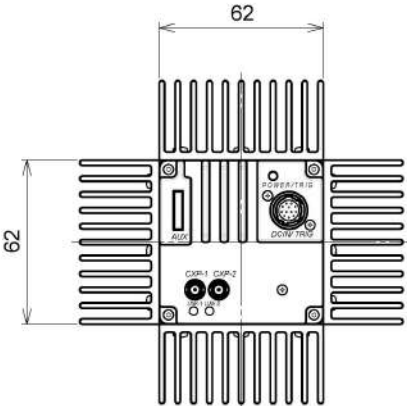
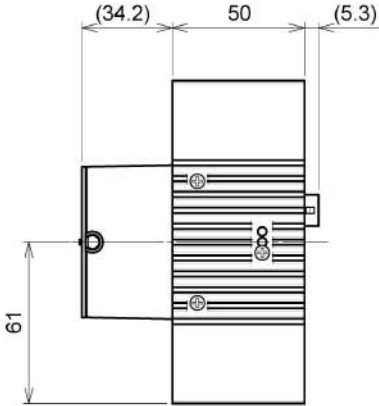
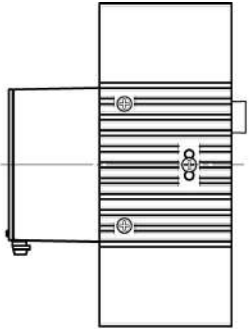
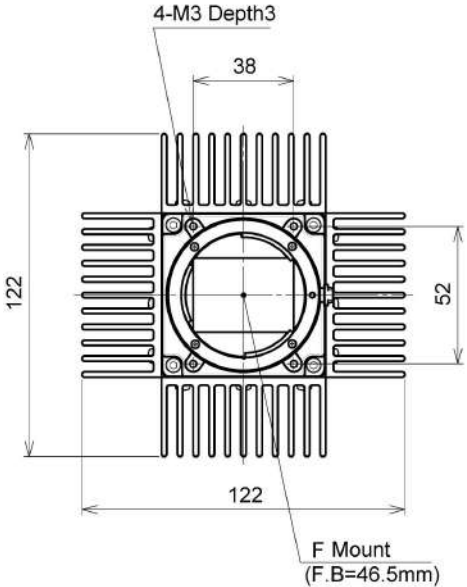

Dimensional tolerance: ± 0.3mm
Unit: mm

Comparison of the Decibel Display and Multiplier Display

Decibels [db]	Multipliers [x]	Remarks
-7	0.447	
-6	0.501	
-5	0.562	
-4	0.631	
-3	0.708	
-2	0.794	
-1	0.891	
0	1	
1	1.122	
2	1.259	
3	1.413	
4	1.585	
5	1.778	
6	1.995	
7	2.239	
8	2.512	
9	2.818	
10	3.162	
11	3.548	
12	3.981	
13	4.467	
14	5.012	
15	5.623	
16	6.31	
17	7.079	
18	7.943	
19	8.913	
20	10	
21	11.22	
22	12.589	
23	14.125	
24	15.849	
25	17.783	
26	19.953	
27	22.387	
28	25.119	
29	28.184	
30	31.623	
31	35.481	
32	39.811	
33	44.668	
34	50.119	
35	56.234	
36	63.096	

User's Record

Camera type: SP-45001M-CXP2A / SP-45001C-CXP2A

Revision:

Serial No:

Firmware version:

For camera revision history, please contact your local JAI distributor.

Trademarks

- Microsoft and Windows are trademarks or registered trademarks of Microsoft Corporation in the United States and other countries.
- Intel and Intel Core are trademarks of Intel Corporation in the United States and other countries.

Other system and product names described in this document are trademarks or registered trademarks of their respective owners. The [™] and ® symbols are not used in this document.

Index

0-9

12-pin round	10
--------------	----

A

Acquisition	20
Adjusting the Black Level	17
Adjusting the Gain	17
ALC	38

B

Binning Function	43
Blemish Compensation	41

C

Camera locking screw holes	13
Connecting Devices	15
Counter And Timer Control	54
CXP Connector	9

D

DC IN	10
DC IN/TRIG connector	10
Digital Input/Output Settings	24
Dimensions	74

E

Event Control	50
Exposure Mode	21

F

Factory default settings	18
Feature Properties	58
Frame rate	20
Frame rate reference	34

G

Gamma Function	39
GPIO	24

H

HDR	27
Heartbeat	19

L

LED	8
Lens	15
Lens mount	8
Lookup Table	40
LUT	40

P

Parts Identification	8
Pixel format	23
POWER/TRIG LED	8

R

ROI	43
-----	----

S

Saving the Settings	18
Sequencer Function	51
Setting List	57
Shading Correction	42
Specifications	70
Spectral Response	73

T

Trigger Control	22
Troubleshooting	69

U

User memory	18
-------------	----

V

Verifying the Connection between the Camera and PC	16
Video Process Bypass Mode	31

Revision history

Revision	Date	Changes
1.5	Feb. 2024	Added the KC marks. Corrected the Frame Rate Calculation topic. Reworded the temperature caution.
1.4	Feb. 2023	Added the Heatsink information.
1.3	Oct. 2021	Added the EventControl and Heatbeat functions.
1.2	Apr. 2021	Change the Caution for the CXP connector.
1.1	Dec. 2020	Fixed (Minimum Exposure Time, PoCXP
1.0	Nov. 2020	First Version