



See the possibilities

User Manual



GOX-5105M-PGE
GOX-8105M-PGE
GOX-12405M-PGE
GOX-16205M-PGE
GOX-20405M-PGE
GOX-24505M-PGE

GOX-5105C-PGE
GOX-8105C-PGE
GOX-12405C-PGE
GOX-16205C-PGE
GOX-20405C-PGE
GOX-24505C-PGE

*CMOS Digital Progressive Scan
Monochrome and Color Camera with GigE Interface*

*Document Version: 1.3
Go-X_Series_PGE_Manual_Ver.1.3_2024-03-21*

Thank you for purchasing this product.

 Be sure to read this documentation before use.

This documentation includes important safety precautions and instructions on how to operate the unit. Be sure to read this documentation to ensure proper operation.

The contents of this documentation are subject to change without notice for the purpose of improvement.

Table of Contents

Table of Contents	2
About Technical Note	8
Notice/Warranty	9
Notice	9
Warranty	9
Certifications	9
CE Compliance	9
FCC	9
Warning	10
KC	10
China RoHS	11
Usage Precautions	12
Notes on Cable Configurations	12
Notes on Attaching the Lens	12
Notes on LAN Cable Connection	12
Phenomena Specific to CMOS Image Sensors	13
Notes on Exportation	13
Features	14
Feature Overview	14
Parts Identification	15
① Lens Mount (C-Mount)	15
② RJ-45 Connector	16
③ LINK LED	16
④ ACT LED	16
⑤ POWER/TRIG LED	17
⑥ DC IN/TRIG Connector (6-Pin Round)	17
⑦ ⑧ Mounting Holes	18
Recommended Circuit Diagram (Reference Examples)	18
Characteristics of the Recommended Circuits for Opto OUT	19

Preparation	20
Step 1: Install the Software (First Time Only)	21
Step 2: Connect Devices	21
① Lens	22
② Mounting (or Use MP-46 Tripod Adapter Plate)	23
③ LAN Cable	23
④ Network Card	23
⑤ DC IN / Trigger IN Connection Cable	23
⑥ AC Adapter (Power Supply) (If Necessary)	24
Step 3: Verify Camera Operation	24
Step 4: Verify the Connection between the Camera and PC	24
Step 5: Change the Camera Settings	27
Step 6: Adjust the Image Quality	28
Adjust the Gain	29
Adjust the White Balance	30
Adjust the Black Level	31
Step 7: Save the Settings	32
To Save User Settings	33
To Load User Settings	34
Main Functions	35
Acquisition Control	35
Changing the Frame Rate	36
Exposure Mode	37
Actual Exposure Time	38
RCT Mode	38
Burst Trigger Mode	39
Burst Trigger Mode Usage Examples	40
Trigger Control	42
When Using the FrameStart Trigger	43
Pixel Format	44
SensorDigitizationBits	45
Image Flip Function	45

GPIO (Digital Input/Output Settings)	46
VideoProcessBypassMode	47
Calculate the Maximum Frame or Trigger Rate (Approximate)	48
1. Calculate the H Period	48
2. Calculate the Minimum Frame Period	51
3. Calculate the Maximum Frame Rate or Maximum Trigger Rate	52
Timing Chart	54
Exposure Mode = Timed (Overlap Readout)	55
GOX-5105M-PGE, GOX-5105C-PGE	56
GOX-8105M-PGE, GOX-8105C-PGE	57
GOX-12405M-PGE, GOX-12405C-PGE	58
GOX-16205M-PGE, GOX-16205C-PGE	59
GOX-20405M-PGE, GOX-20405C-PGE	60
GOX-24505M-PGE, GOX-24505C-PGE	61
Exposure Mode = TriggerWidth (Overlap Readout)	62
GOX-5105M-PGE, GOX-5105C-PGE	63
GOX-8105M-PGE, GOX-8105C-PGE	64
GOX-12405M-PGE, GOX-12405C-PGE	65
GOX-16205M-PGE, GOX-16205C-PGE	66
GOX-20405M-PGE, GOX-20405C-PGE	67
GOX-24505M-PGE, GOX-24505C-PGE	68
Exposure Mode = Timed (RCT Mode)	69
GOX-5105M-PGE, GOX-5105C-PGE	70
GOX-8105M-PGE, GOX-8105C-PGE	71
GOX-12405M-PGE, GOX-12405C-PGE	72
GOX-16205M-PGE, GOX-16205C-PGE	73
GOX-20405M-PGE, GOX-20405C-PGE	74
GOX-24505M-PGE, GOX-24505C-PGE	75
Gain Control	76
Automatic Gain Level Control	76
White Balance	77
Color Temperature	77

ALC (Automatic Level Control) Function	78
To Use the ALC Function	78
Gamma Function	79
To Use the Gamma Function	79
LUT (Lookup Table)	80
To Use the LUT Function	80
LUT Value	80
BlemishCompensation	81
Automatic Detection	81
Manual Configuration	82
Shading Correction	83
To Use the Shading Correction Function	84
Binning Function	85
Image Scaling Mode (Xscale)	86
Specifying the Scaling Ratio	87
Decimation Mode	89
Image Compression Mode (Xpress)	90
How to Display Compressed Image	90
How to Configure	91
Download eBUS Player for Xpress	91
Configure the PixelFormat and Width Settings	92
Configure the Acquisition Frame Rate	93
Low Compression Ratio with Overflowing I/F Bandwidth	95
How to Use Decompression Library	96
Gradation Compression Mode	98
Examples	99
Overlay Mode	101
ROI Function (Single ROI)	102
Single ROI - Example	103
ROI Centered	104
ROI Function (Multi ROI)	105
Configuration Example	107

Color Space Conversion (ColorTransformationControl)	108
Edge Enhancer, Color Enhancer	110
Sequencer Function	111
TriggerSequencer Mode	111
Sample TriggerSequencer Mode Operation	112
CommandSequencer Mode	113
Pulse Generator	114
Counter and Timer Control Function	115
Counter Occurrence Diagram	115
Internal Camera Blocks	116
To Use the Counter Function	116
Action Control Function	117
Action Control Example	118
Event Control Function	119
Chunk Data Function	120
PTP (Precision Time Protocol)	121
Functions That Cannot Be Used Together	122
Setting List (Feature Properties)	123
DeviceControl	124
TransportLayerControl	126
ImageFormatControl	131
MultiROIControl	139
AcquisitionControl	140
DigitalIOControl	143
PulseGenerator	145
AnalogControl	148
LUTControl	150
AutoLevelControl	151
ColorTransformationControl	153
ImagingControl	154
ShadingControl	155
BlemishControl	156

SequencerControl	157
CounterAndTimerControl	160
ActionControl	161
EventControl	162
ChunkDataControl	164
TestControl	165
UserSetControl	165
Miscellaneous	166
Troubleshooting	166
Power Supply and Connections	166
Image Display	166
Settings and Operations	166
Specifications	167
Package Contents	174
Spectral Response (GOX-5105M-PGE/GOX-5105C-PGE)	175
Spectral Response (GOX-8105M-PGE/GOX-8105C-PGE)	176
Spectral Response (GOX-12405M-PGE/GOX-12405C-PGE)	177
Spectral Response (GOX-16205M-PGE/GOX-16205C-PGE)	178
Spectral Response (GOX-20405M-PGE/GOX-20405C-PGE)	179
Spectral Response (GOX-24505M-PGE/GOX-24505C-PGE)	180
Dimensions	181
Comparison of the Decibel Display and Multiplier Display	182
User's Record	183
Revision History	184

About Technical Note



Some additional technical information is provided on the JAI website as Technical Notes. In this manual, if a technical note is available for a particular topic, the above icon is shown. Please refer to the following URL for Technical notes.

<https://www.jai.com/support-software/technical-notes>

Notice/Warranty

Notice

The material contained in this manual consists of information that is proprietary to JAI Ltd., Japan, and may only be used by the purchasers of the product. JAI Ltd., Japan makes no warranty for the use of its product and assumes no responsibility for any errors which may appear or for damages resulting from the use of the information contained herein. JAI Ltd., Japan reserves the right to make changes without notice.

Company and product names mentioned in this manual are trademarks or registered trademarks of their respective owners.

Warranty

For information about the warranty, please contact your factory representative.

Certifications

CE Compliance

As defined by the Directive 2004/108/EC of the European Parliament and of the Council, EMC (Electromagnetic compatibility), JAI Ltd., Japan declares that GOX-5105M-PGE, GOX-5105C-PGE, GOX-8105M-PGE, GOX-8105C-PGE, GOX-12405M-PGE, GOX-12405C-PGE, GOX-16205M-PGE, GOX-16205C-PGE, GOX-20405M-PGE, GOX-20405C-PGE, GOX-24505M-PGE, and GOX-24505C-PGE comply with the following provisions applying to their standards.

EN 55032:2015(CISPR32:2015)

EN 55035:2017(CISPR35:2016)

FCC

This equipment has been tested and found to comply with the limits for a Class B digital device, pursuant to Part 15 of the FCC Rules. These limits are designed to provide reasonable protection against harmful interference in a residential installation. This equipment generates, uses, and can radiate radio frequency energy and, if not installed and used in accordance with the instructions, may cause harmful interference to radio communications. However, there is no guarantee that interference will not occur in a particular installation. If this equipment does cause harmful interference to radio or television reception, which can be determined by turning the equipment off and on, the user is encouraged to try to correct the interference by one or more of the following measures:

- Reorient or relocate the receiving antenna.
- Increase the separation between the equipment and receiver.

- Connect the equipment into an outlet on a circuit different from that to which the receiver is connected.
- Consult the dealer or an experienced radio/TV technician for help.

Warning

Changes or modifications to this unit not expressly approved by the party responsible for FCC compliance could void the user's authority to operate the equipment.

KC



상 호: JAI Ltd.,Japan
 기자재명칭: Industrial camera
 모 델 명: GOX-5105M-PGE
 제조자 및 제조국가: JAI Ltd.,Japan / JAPAN
 R-R-JAI-GOX-24505M-PGE



상 호: JAI Ltd.,Japan
 기자재명칭: Industrial camera
 모 델 명: GOX-5105C-PGE
 제조자 및 제조국가: JAI Ltd.,Japan / JAPAN
 R-R-JAI-GOX-24505M-PGE



상 호: JAI Ltd.,Japan
 기자재명칭: Industrial camera
 모 델 명: GOX-8105M-PGE
 제조자 및 제조국가: JAI Ltd.,Japan / JAPAN
 R-R-JAI-GOX-24505M-PGE



상 호: JAI Ltd.,Japan
 기자재명칭: Industrial camera
 모 델 명: GOX-8105C-PGE
 제조자 및 제조국가: JAI Ltd.,Japan / JAPAN
 R-R-JAI-GOX-24505M-PGE



상 호: JAI Ltd.,Japan
 기자재명칭: Industrial camera
 모 델 명: GOX-12405M-PGE
 제조자 및 제조국가: JAI Ltd.,Japan / JAPAN
 R-R-JAI-GOX-24505M-PGE



상 호: JAI Ltd.,Japan
 기자재명칭: Industrial camera
 모 델 명: GOX-12405C-PGE
 제조자 및 제조국가: JAI Ltd.,Japan / JAPAN
 R-R-JAI-GOX-24505M-PGE



상 호: JAI Ltd.,Japan
 기자재명칭: Industrial camera
 모 델 명: GOX-16205M-PGE
 제조자 및 제조국가: JAI Ltd.,Japan / JAPAN
 R-R-JAI-GOX-24505M-PGE



상 호: JAI Ltd.,Japan
 기자재명칭: Industrial camera
 모 델 명: GOX-16205C-PGE
 제조자 및 제조국가: JAI Ltd.,Japan / JAPAN
 R-R-JAI-GOX-24505M-PGE



상 호: JAI Ltd.,Japan
 기자재명칭: Industrial camera
 모 델 명: GOX-20405M-PGE
 제조자 및 제조국가: JAI Ltd.,Japan / JAPAN
 R-R-JAI-GOX-24505M-PGE



상 호: JAI Ltd.,Japan
 기자재명칭: Industrial camera
 모 델 명: GOX-20405C-PGE
 제조자 및 제조국가: JAI Ltd.,Japan / JAPAN
 R-R-JAI-GOX-24505M-PGE



상 호: JAI Ltd.,Japan
 기자재명칭: Industrial camera
 모 델 명: GOX-24505M-PGE
 제조자 및 제조국가: JAI Ltd.,Japan / JAPAN
 R-R-JAI-GOX-24505M-PGE



상 호: JAI Ltd.,Japan
 기자재명칭: Industrial camera
 모 델 명: GOX-24505C-PGE
 제조자 및 제조국가: JAI Ltd.,Japan / JAPAN
 R-R-JAI-GOX-24505M-PGE

제조년월은 제품상자의 라벨을 참조하십시오.

China RoHS

The following statement is related to the regulation on “Measures for the Administration of the Control of Pollution by Electronic Information Products”, known as “China RoHS”. The table shows contained Hazardous Substances in this camera.

 mark shows that the environment-friendly use period of contained Hazardous Substances is 15 years.

重要注意事项

有毒有害物质或元素名称及含量表

根据中华人民共和国信息产业部『电器电子产品有害物质限制使用管理办法』，本产品《有毒有害物质或元素名称及含量表》如下。

部件名称	有毒有害物质或元素					
	铅 (Pb)	汞 (Hg)	镉 (Cd)	六价铬 (Cr (VI))	多溴联苯 (PBB)	多溴二苯醚 (PBDE)
GOX-5105MC-PGE GOX-8105MC-PGE GOX-12405MC-PGE GOX-16205MC-PGE GOX-20405MC-PGE GOX-24505MC-PGE	x	○	○	○	○	○

○:表示该有毒有害物质在该部件所有均质材料中的含量均在 GB/T 26572-2011规定的限量要求以下。
x:表示该有毒有害物质至少在该部件的某一均质材料中的含量超出 GB/T 26572-2011规定的限量要求。

环保使用期限



电子信息产品中含有的有毒有害物质或元素在正常使用的条件下不会发生外泄或突变、电子信息产品用户使用该电子信息产品不会对环境造成严重污染 或对其人身、财产造成严重损害的期限。

数字「15」为期限15年。

Usage Precautions

Notes on Cable Configurations

The presence of lighting equipment and television receivers nearby may result in video noise. In such cases, change the cable configurations or placement.

Notes on Attaching the Lens



Technical Notes

How to Clean a Sensor

Avoiding Dust Particles

When attaching the lens to the camera, stray dust and other particles may adhere to the sensor surface and rear surface of the lens. Be careful of the following when attaching the lens.

- Work in a clean environment.
- Do not remove the caps from the camera and lens until immediately before you attach the lens.
- To prevent dust from adhering to surfaces, point the camera and lens downward and do not allow the lens surface to come into contact with your hands or other objects.
- Always use a blower brush to remove any dust that adheres.
- Never use your hands or cloth, blow with your mouth, or use other methods to remove dust.

Notes on LAN Cable Connection

Secure the locking screws on the connector manually, and do not use a driver. Do not secure the screws too tightly. Doing so may wear down the screw threads on the camera. (Tightening torque: 0.147 Nm or less)

Caution: Secure manually. Do not secure too tightly.

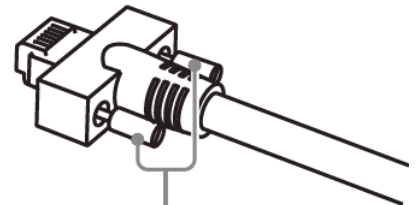

Phenomena Specific to CMOS Image Sensors

The following phenomena are known to occur on cameras equipped with CMOS image sensors. These do not indicate malfunctions.

- **Aliasing:** When shooting straight lines, stripes, and similar patterns, vertical aliasing (zigzag distortion) may appear on the monitor.
- **Blooming:** When strong light enters the camera, some pixels on the CMOS image sensor may receive much more light than they are designed to hold, causing the accumulated signal charge to overflow into surrounding pixels. This “blooming” phenomenon can be seen in the image but does not affect the operation of the camera.
- **Fixed pattern noise:** When shooting dark objects in high-temperature conditions, fixed pattern noise may occur throughout the entire video monitor screen.
- **Defective pixels:** Defective pixels (white and black pixels) of the CMOS image sensor are minimized at the factory according to shipping standards. However, as this phenomenon can be affected by the ambient temperature, camera settings (e.g., high sensitivity and long exposure), and other factors, be sure to operate within the camera’s specified operating environment.
- **Vertical stripes:** Due to the design characteristics of the sensor used, vertical stripes may appear in the image when using the camera under the following condition(s), especially a combination of these circumstances:
 - A shallow incident angle, a large aperture, a short exposure time, and/or the use of long-waveband lighting (especially infrared)

You may be able to improve the vertical stripes in the image by changing the above condition(s) (e.g., smaller aperture, longer shutter speed).

Notes on Exportation

When exporting this product, please follow the export regulations of your country or region.

Features

These camera models are industrial progressive scan cameras equipped with a global shutter CMOS image sensor. These small-size cameras (approx. 29mm x 29mm x 55mm) are also lightweight (70 g), which makes them easy to install and mount. In addition, these provide an attractive combination of high resolution, high speed, and high image quality for machine vision applications.

Model Name	Image Sensor		Active Pixels	Pixel Size	Max Frame Rate*
GOX-5105M-PGE	Mono	Type 1/1.8	2472 x 2064	2.74 μm x 2.74 μm	23 fps
GOX-5105C-PGE	Color				
GOX-8105M-PGE	Mono	Type 2/3	2856 x 2848	2.74 μm x 2.74 μm	15 fps
GOX-8105C-PGE	Color				
GOX-12405M-PGE	Mono	Type 1/1.1	4128 x 3008	2.74 μm x 2.74 μm	9 fps
GOX-12405C-PGE	Color				
GOX-16205M-PGE	Mono	Type 1.1	5328 x 3040	2.74 μm x 2.74 μm	7 fps
GOX-16205C-PGE	Color				
GOX-20405M-PGE	Mono	Type 1.1	4512 x 4512	2.74 μm x 2.74 μm	6 fps
GOX-20405C-PGE	Color				
GOX-24505M-PGE	Mono	Type 1.2	5328 x 4608	2.74 μm x 2.74 μm	5 fps
GOX-24505C-PGE	Color				

*When Pixel Format = **Mono8/BayerRG8**, SensorDigitizationBits = **10 Bits**, NetworkThroughputSafetyMargin = **100**, Packet Size = **12036**, ExtendedIDMode = **Off**.

Feature Overview

- Global shutter CMOS image sensor with backside illuminated pixel technology
- 8/10/12-bit output in choice of monochrome or raw Bayer color models
- Can perform lossless compression of images to support higher frame rates; Flexible ROI; rescaling function (monochrome and color); traditional 1x2, 2x1, 2x2 binning (monochrome models); horizontal/vertical image flip function; blemish correction; shading compensation; sequencer function; and Automatic Level Control (ALC). (See the [Main Functions](#) chapter for details).
- Compact size with excellent shock and vibration resistance
- PoE or via separate 6-pin connector
- Lens mount: C-mount

Parts Identification

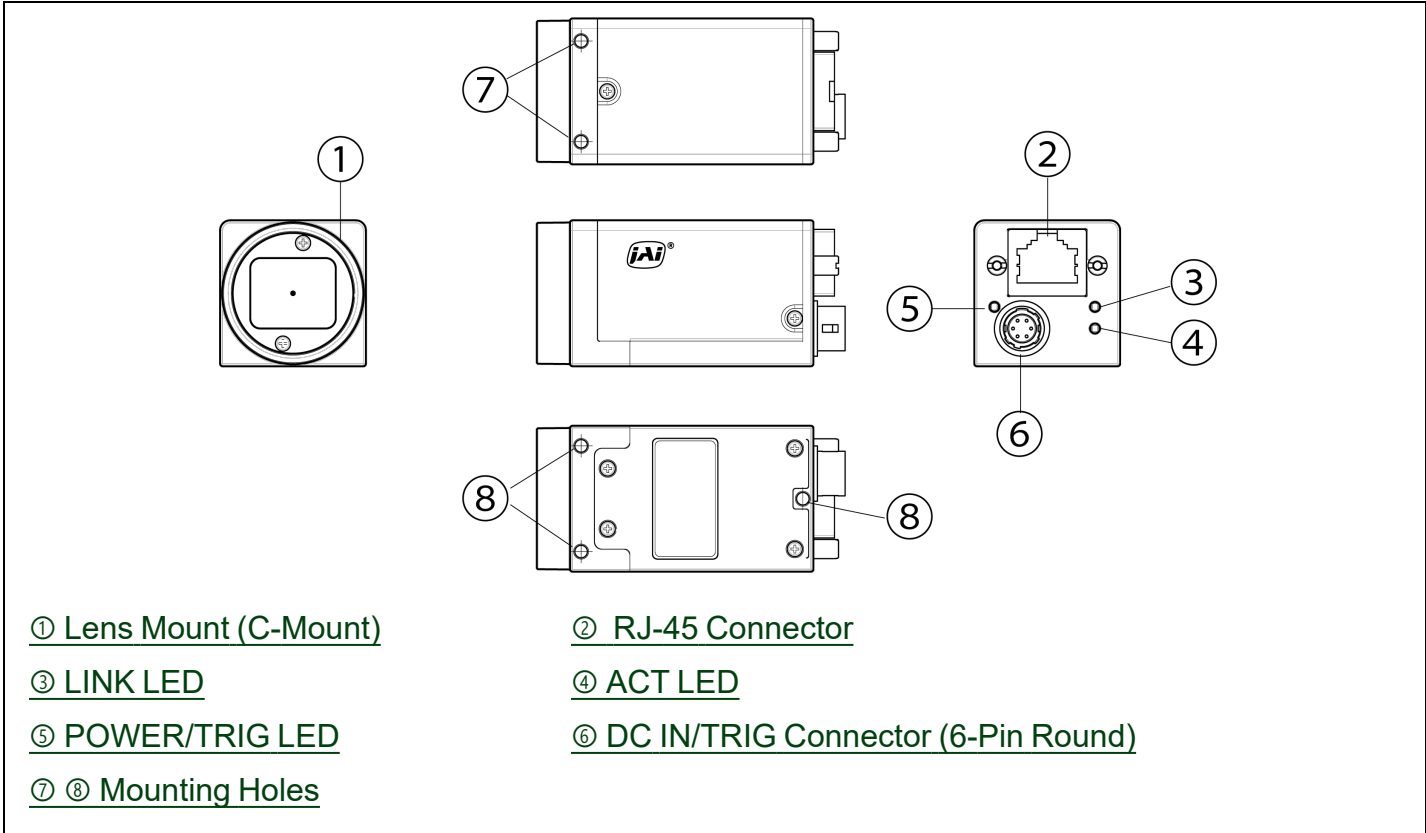

① Lens Mount (C-Mount)

Mount a C-mount lens, microscope adapter, etc. here.

Note: Before mounting a lens, be sure to refer to [① Lens](#) and confirm the precautions for attaching a lens and the supported lens types.

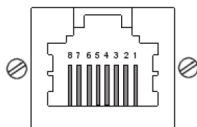

② RJ-45 Connector

Connect a Gigabit Ethernet compatible LAN cable (Category 5e or higher, Category 6 recommended) here.

 <p>RJ45 with Locking Screws</p>	GigE Vision Interface	
	Pin	Signal
	1	TRD+ (0)
	2	TRD- (0)
	3	TRD+ (1)
	4	TRD+ (2)
	5	TRD- (2)
	6	TRD- (1)
	7	TRD+ (3)
8	TRD- (3)	



③ LINK LED

Indicates whether the GigE network connection is established or not.

LED		Status
	Off	The network link is not established (or in progress).
	Lit green	1000Base-T link is established.



④ ACT LED

Indicates the GigE network status.

LED		Status
	Off	Communication is not active.
	Blinking amber	Communication is active.

⑤ POWER/TRIG LED

Indicates the power or trigger input status.

LED		Status
	Lit amber	Camera initializing
	Lit green	Camera in operation
	Blinking green	During operation in trigger mode, trigger signals are being input. Note: The blinking interval is not related to the actual input interval of the external trigger.

⑥ DC IN/TRIG Connector (6-Pin Round)

Connect the cable for a power supply (optional) or for DC IN / trigger IN here.

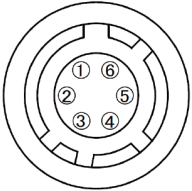
	Camera Side: HR10A-7R-6PB (Hirose Electric or equivalent)			
	Cable Side: : HR10A-7P-6S (Plug) (Hirose Electric or equivalent)			
	Pin No.	Input/Output	Signal	Description
	1	Power In	DC In	DC in +10V ~ +25V
	2	In	Opto In+	Line 5
	3	In	Opto In-	
	4	Out	Opto Out+	Line 2
	5	Out	Opto Out-	
6	GND	GND		

Notes:

- See [Recommended Circuit Diagram \(Reference Examples\)](#) for the recommended Input/Output circuit diagrams.
- Refer to the [GPIO \(Digital Input/Output Settings\)](#) topic as well.

⑦ ⑧ Mounting Holes

Use these holes when mounting the camera directly to a wall or other structural system.

- ⑦ Upper part of camera: M3, 3mm depth, 20mm pitch
- ⑧ Lower part of camera: M3, 4mm depth, 21mm pitch (lens side)

Recommended Circuit Diagram (Reference Examples)

Related Setting Items: [DigitalIOControl](#)

Technical Notes OPTO-In Circuit Characteristics

Note: The OptInFilter function ([DeviceControl](#)) can eliminate the chattering that occurs when switching between the Low and High OptoIn signals up to 40ms.

Recommended External Input Circuit Diagram

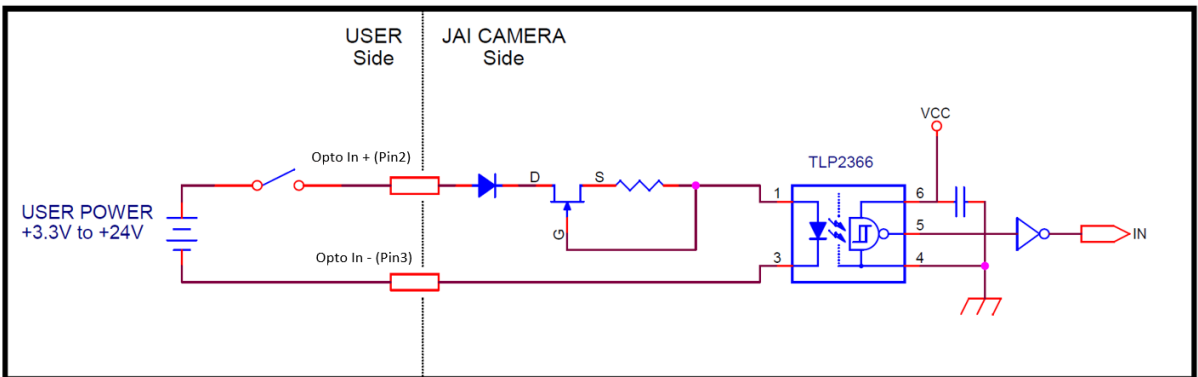

Recommended External Output Circuit Diagram (Reference Example)

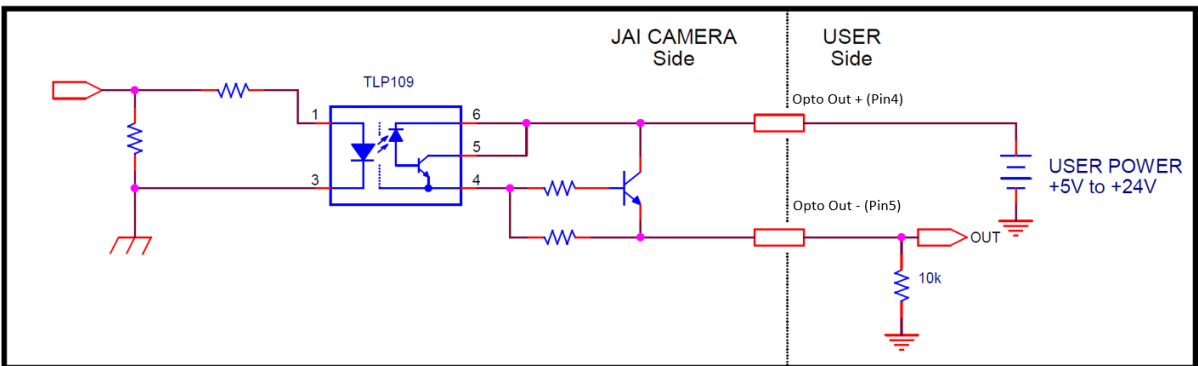

Characteristics of the Recommended Circuits for Opto OUT

OUTPUT LINE RESPONSE TIME

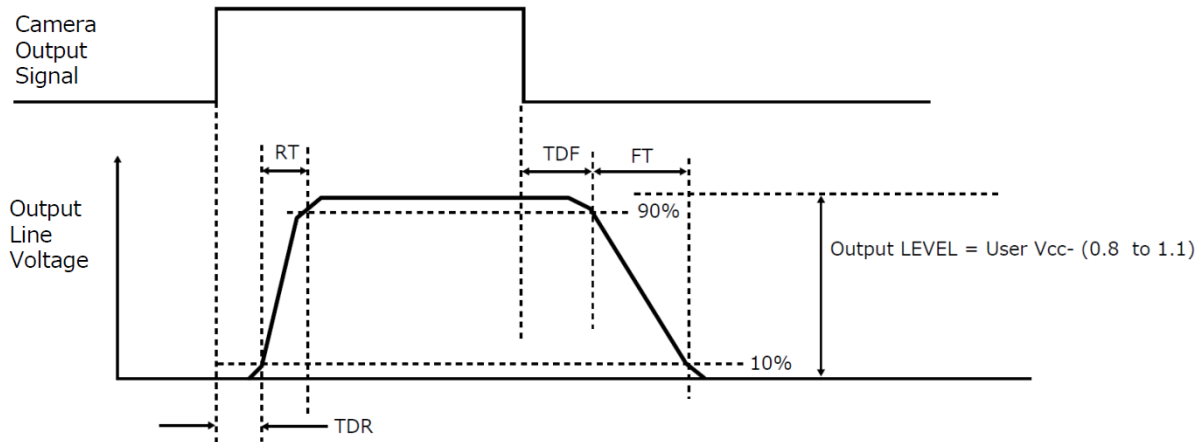

For the operating conditions of applied voltage (User Power) +12V, load resistance 10kΩ, and cable length 1m, the timing is shown in the table below.

Item	Result (Typ)
TDR (Time Delay Rise)	0.48 (μs)
RT (Rise Time)	3.08 (μs)
TDF (Time Delay Fall)	3.16 (μs)
FT (Fall Time)	52.4 (μs)

Note: Since it varies depending on the applied voltage, load resistance, cable length, etc., check the actual environment before use.

Cautions:

Please note that the recommended load resistance of Opto output is 10 kΩ (rated 1/10 W) or more. The 270 Ω resistor shown in the circuit diagram is the MINIMUM resistance that should be used. The response speed from On (High) to Off (Low) depends on the voltage applied to Opto output and the value of the load resistance. Higher load resistance results in a slower response. If the response at 10 kΩ is slower than desired, you can try reducing the load resistance in order to increase the response speed but DO NOT go below the minimum 270 Ω value.

The load resistance loss can be calculated as follows.

$$\text{load resistance loss} \approx (\text{voltage applied to Opto output})^2 / (\text{load resistance})$$

Preparation

Read this section to learn how the camera connects to devices and accessories. The preparation process is described below.

1	<p><u>Step 1: Install the Software (First Time Only)</u></p> <ul style="list-style-type: none"> • Install the software for configuring and controlling the camera (eBUS SDK for JAI) on the computer.
2	<p><u>Step 2: Connect Devices</u></p> <ul style="list-style-type: none"> • Verify whether the camera is turned on and ready for use.
3	<p><u>Step 3: Verify Camera Operation</u></p> <ul style="list-style-type: none"> • Verify whether the camera is turned on and ready for use.
4	<p><u>Step 4: Verify the Connection between the Camera and PC</u></p> <ul style="list-style-type: none"> • Verify whether the camera is properly recognized via Control Tool.
5	<p><u>Step 5: Change the Camera Settings</u></p> <ul style="list-style-type: none"> • Refer to the procedure for changing the output format setting as an example and change various settings as necessary.
6	<p><u>Step 6: Adjust the Image Quality</u></p> <ul style="list-style-type: none"> • Refer to the procedures for adjusting the gain, white balance, and black level as examples, and adjust the image quality.
7	<p><u>Step 7: Save the Settings</u></p> <ul style="list-style-type: none"> • Save the current setting configurations in user memory.

Step 1: Install the Software (First Time Only)

When using the camera for the first time, install the software for configuring and controlling the camera (eBUS SDK for JAI) on the computer.

Note: When you install eBUS SDK for JAI, eBUS Player for JAI will also be installed.

1. Download the eBUS SDK for JAI from the JAI website (<https://www.jai.com/support-software/jai-software>).
2. Install eBUS SDK for JAI on the computer.

Step 2: Connect Devices

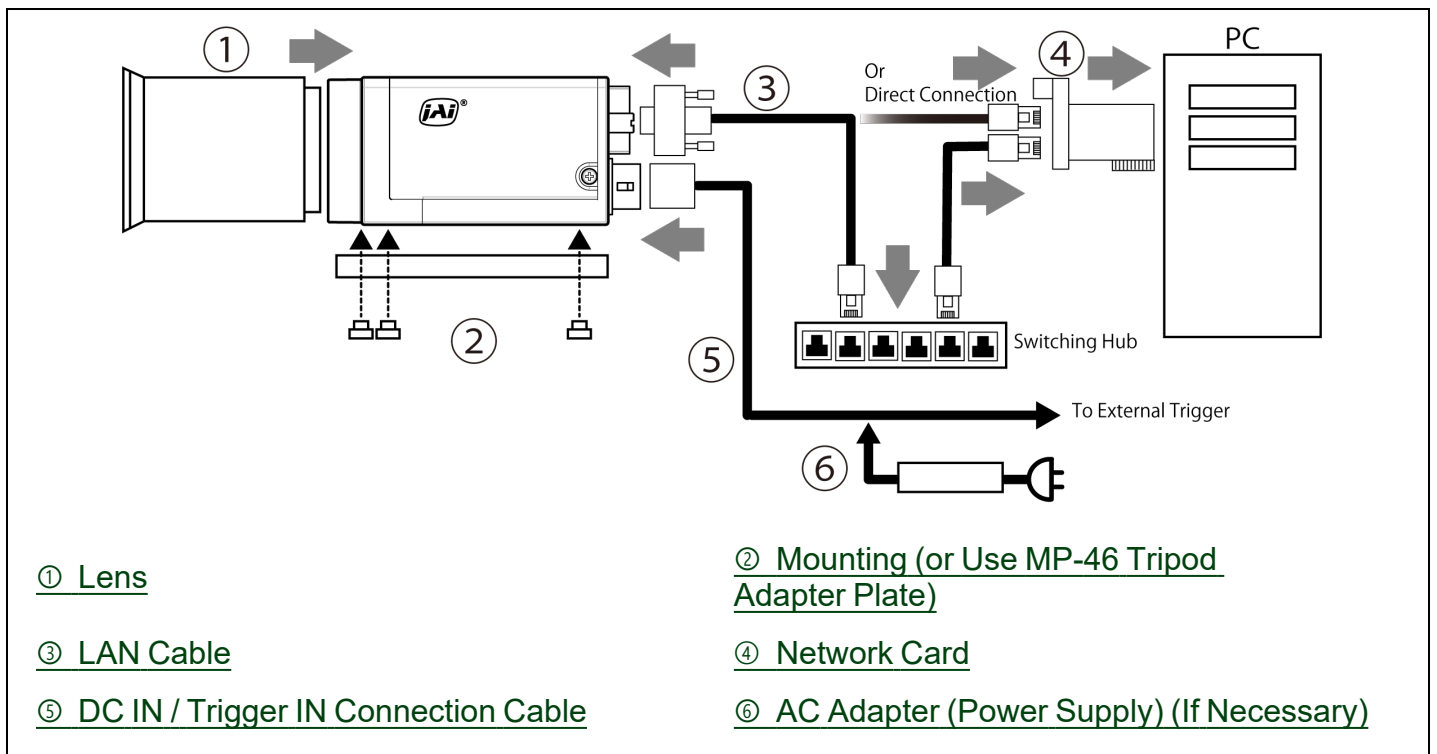

① Lens

Technical Notes Lens Selection Guide

C-mount lenses with lens mount protrusions of 9 mm or less can be attached.

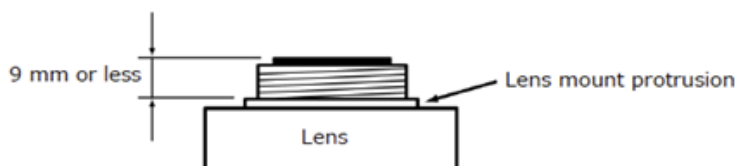

To prevent vignetting and to obtain the optimal resolution, use a lens that will cover the image sensor size.

Model Name	Image Sensor		
GOX-5105M-PGE	Mono	Type 1/1.8	6.8 mm x 5.7 mm (8.82mm diagonal)
GOX-5105C-PGE	Color		
GOX-8105M-PGE	Mono	Type 2/3	7.8 mm x 7.8 mm (11.05mm diagonal)
GOX-8105C-PGE	Color		
GOX-12405M-PGE	Mono	Type 1/1.1	11.3 mm x 8.2 mm (14.00mm diagonal)
GOX-12405C-PGE	Color		
GOX-16205M-PGE	Mono	Type 1.1	14.6 mm x 8.3 mm (16.81mm diagonal)
GOX-16205C-PGE	Color		
GOX-20405M-PGE	Mono	Type 1.1	12.4 mm x 12.4 mm (17.48mm diagonal)
GOX-20405C-PGE	Color		
GOX-24505M-PGE	Mono	Type 1.2	14.6 mm x 12.6 mm (19.30mm diagonal)
GOX-24505C-PGE	Color		

Notes:

The following formula can be used to estimate the focal length.

$$\text{Focal length} = \text{WD} / (1 + \text{W/w})$$

WD: Working distance (distance between lens and object)

W: Width of object

w: Width of sensor

Cautions:

- The maximum performance of the camera may not be realized depending on the lens.
- Attaching a lens with a mount protrusion of 9 mm or longer may damage the lens or camera.

② Mounting (or Use MP-46 Tripod Adapter Plate)

When mounting the camera directly to a wall or other device, use screws that match the camera locking screw holes on the camera (M3: depth 4mm for the lower part, depth 3 mm for the upper part).

Use the supplied screws to attach the tripod adapter plate (lower mounting holes).

Caution: For heavy lenses, be sure to support the lens itself. Do not use configurations in which its weight is supported by the camera.

③ LAN Cable

Connect a LAN cable to the RJ-45 connector.

- Use a LAN cable that is Category 5e or higher (Category 6 recommended).
- Use a LAN cable that is an STP cable.
- When supplying power via PoE, connect to a PoE-compatible switching hub or a PoE-compatible network card.

Note: JAI does not recommend using a PoE injector. If a PoE injector is used, the camera may not be able to transmit images properly.

- Refer to the specifications of the cable for details on its bend radius.

Caution: See the [Notes on LAN Cable Connection](#) topic as well.

④ Network Card

Install this in the computer that will be used to configure and operate the camera. As the camera supports PoE, you can also use PoE-compatible network cards. Refer to the instruction manual of the network card and configure settings on the computer as necessary.

⑤ DC IN / Trigger IN Connection Cable

Performs external I/O such as power supply and trigger input.

⑥ AC Adapter (Power Supply) (If Necessary)

Connect the AC adapter and the round connector of the connection cable to the DC IN / Trigger IN connector on the camera.

Step 3: Verify Camera Operation

When power is supplied to the camera while the necessary equipment is connected, the POWER/TRIG LED at the rear of the camera lights amber, and initialization of the camera starts. When initialization is complete, the POWER/TRIG LED lights green.

Verify whether power is being supplied to the camera by checking the rear LED. When properly turned on, the power LED is lit green.

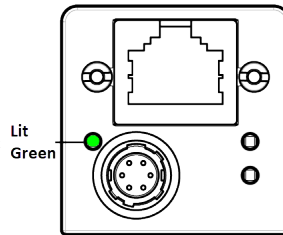

For details on how to read the LEDs, see the [⑤ POWER/TRIG LED](#) section.

Step 4: Verify the Connection between the Camera and PC

Verify whether the camera is properly recognized via Control Tool.

1. Launch eBUS Player for JAI



eBUS Player for JAI startup screen appears.

2. Select the camera you want to configure. Click the **Select / Connect** button.

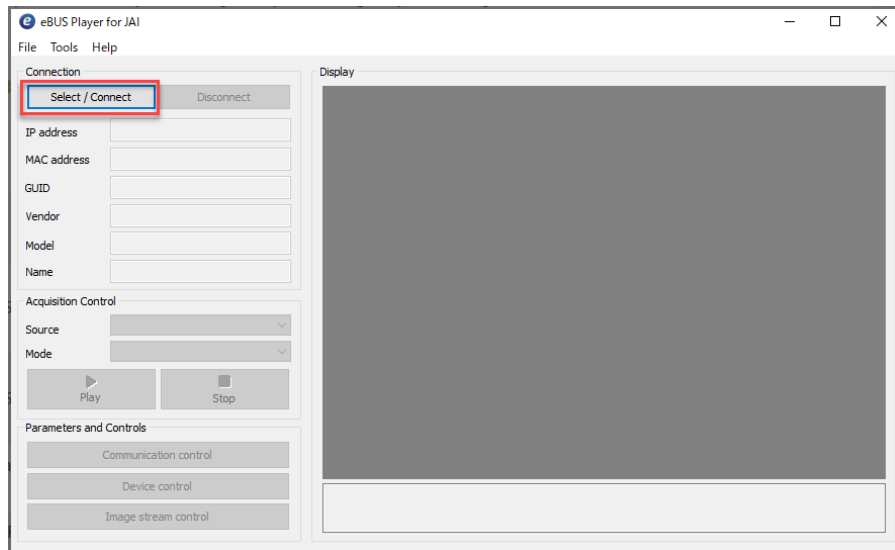

3. The connected camera is listed. Please select one camera and click **OK**.

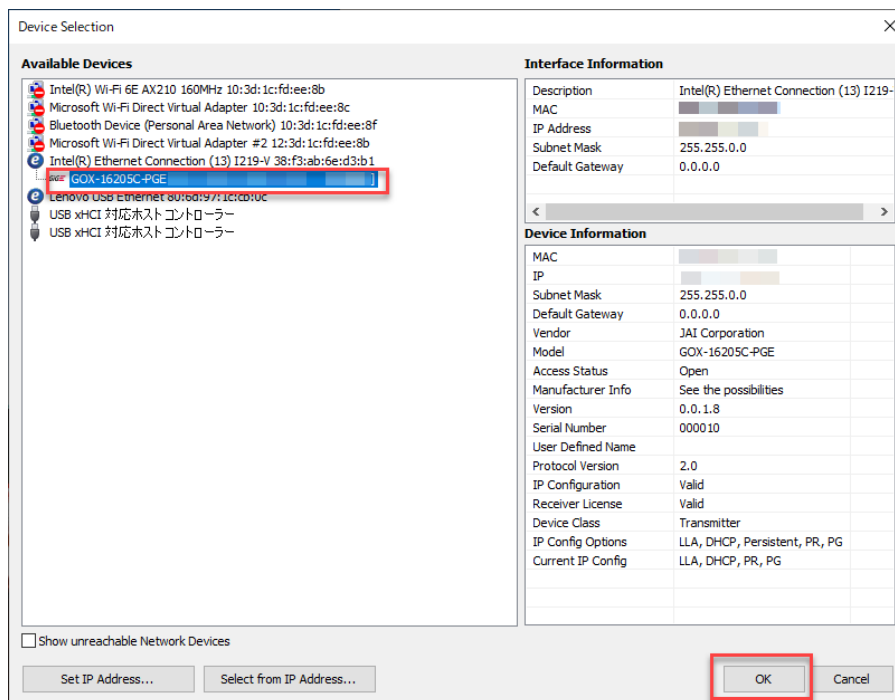

4. Check that the settings of the selected camera are displayed.

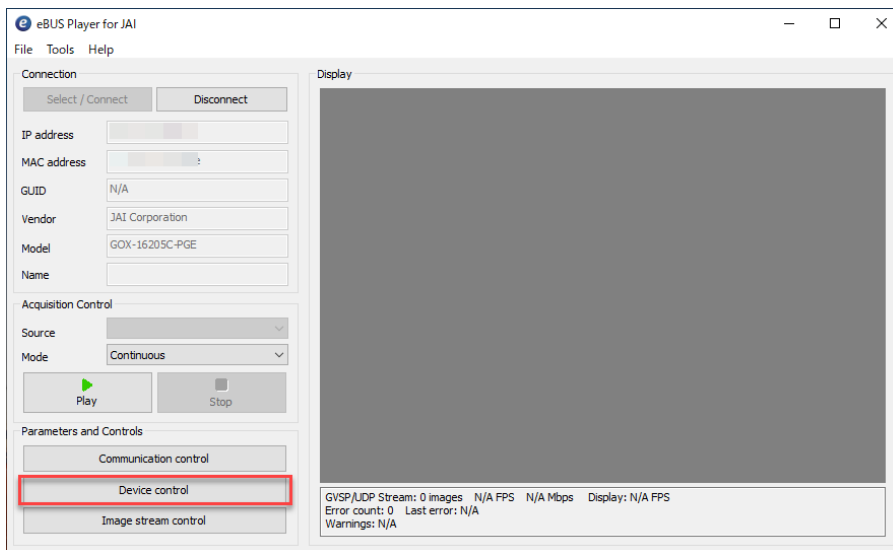

5. Click the **Device control** button. The screen shown below will be displayed. In this window, you can adjust various settings of the camera.

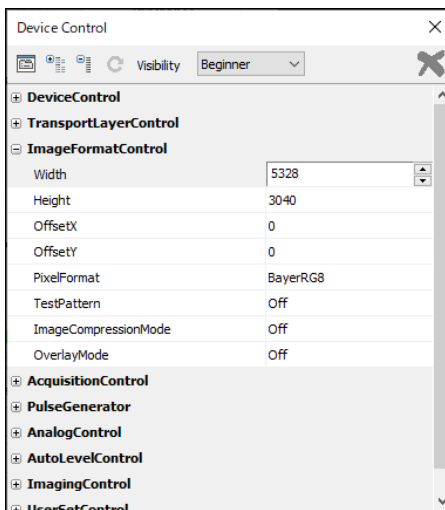

This completes the procedure for verifying whether the camera is properly recognized and whether control and settings configuration are possible.

Step 5: Change the Camera Settings

This section explains how to change settings by describing the procedure for changing the output format as an example.

Configure the Output Format

Configure the size, position, and pixel format of the images to be acquired. The factory settings are as follows. Change the settings as necessary.

Factory default values (GOX-16205C-PGE)

Item		Default Value
ImageFormatControl	Width	5328
	Height	3040
	OffsetX	0
	OffsetY	0
	PixelFormat	BayerRG8

Note: You can specify the image acquisition area. For details, see [“ROI Function \(Single ROI\)”](#).

Example: Configure the Width of ImageFormatControl

1. By selecting the item of Width, you can change the value as shown below.

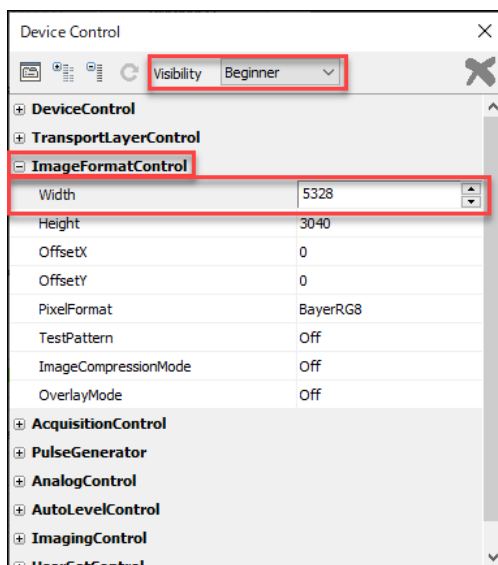

Note: Depending on the setting item, you need to change visibility. Please switch visibility (Beginner / Expert / Guru) as necessary.

Step 6: Adjust the Image Quality

Related Setting Items: [AnalogControl](#)

Display the camera image and adjust the image quality.

■ Display the Image

Display the image captured by the camera. When you click the **Play** button, the camera image appears in the right area.

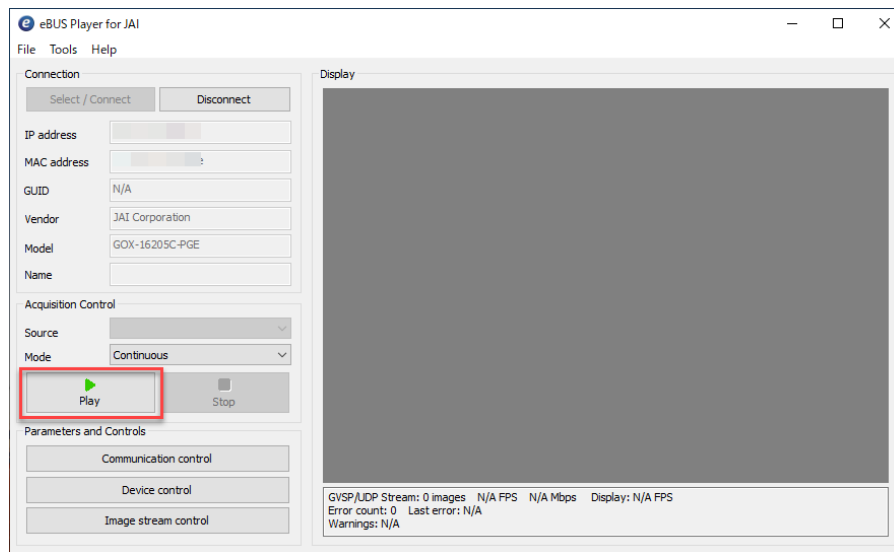

Note: It is recommended to set **GevGVCPPendingAck** in [TransportLayerControl](#) to **True**. When a time-consuming process such as white balance is performed, this camera returns an Ack response when the process is completed. In this case, some camera control software may cause a timeout error without waiting for an Ack response from the camera. When the **GevGVCPPendingAck** setting is enabled, if a time-consuming process is performed, the camera immediately returns a Pending Ack response and returns an Ack response when the processing is completed. The Timeout errors are prevented.

Adjust the Gain

Adjust the image quality using the gain and white balance functions. The Visibility must be changed from Beginner to **Guru**.

Note: For details on the Gain control, see [Gain Control](#) in the Main Functions chapter.

Manual Adjustment

1. Expand **AnalogControl** and set GainAuto to **Off** (Default = Off).

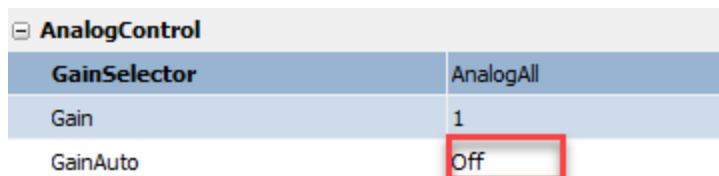

2. Select the gain you want to configure in GainSelector. AnalogAll (master gain), DigitalRed* (digital R gain), and DigitalBlue* (digital B gain) can be configured.



3. Configure the Gain.

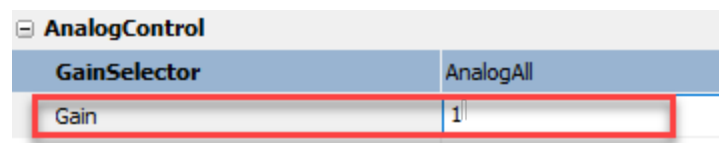

- DigitalAll (master gain) can be set to a value from x1 to x126 the analog gain value. The resolution is set in about 0.1dB steps. Values are configured by multipliers.
- The DigitalRed* (digital R gain) and DigitalBlue* (digital B gain) can be set to a value from x0.447 to x5.624. Values are configured by multipliers.

Note: *Color models only.

Adjust the White Balance

Adjust the white balance using the automatic adjustment function.

Note: The white balance is only supported on color models.

Automatic White Balance Adjustment

1. Place a white sheet of paper or similar object under the same lighting conditions as the intended subject and zoom in to capture the white.

White objects near the subject, such as a white cloth or wall, can also be used. Be sure to prevent the high-intensity spotlights from entering the screen.

2. Select the **BalanceWhiteAuto** tab and select **Continuous** or **Once** for the adjustment method.

AnalogControl	
GainSelector	AnalogAll
Gain	1
GainAuto	Off
BlackLevelSelector	All
BlackLevel	0
BalanceWhiteAuto	Off
AWBAreaSelector	Off
AWBAreaEnable	Once
	Continuous

The white balance is automatically adjusted.

Note: For Continuous and Once, white balance is adjusted using R/B Gain.

Adjust the Black Level

1. Expand **AnalogControl**, and select the black level you want to configure in **BlackLevelSelector**. All (master black), Red* (digital R), and Blue* (digital B) can be configured.

Note: *Color models only.

[-] AnalogControl	
GainSelector	AnalogAll
Gain	1
GainAuto	Off
BlackLevelSelector	All
BlackLevel	All
BalanceWhiteAuto	
AWBAreaSelector	

2. Specify the adjustment value in BlackLevel.

[-] AnalogControl	
GainSelector	AnalogAll
Gain	1
GainAuto	Off
BlackLevelSelector	All
BlackLevel	0

Step 7: Save the Settings

Related Setting Items: [UserSetControl](#)

The setting values configured in eBUS SDK for JAI will be deleted when the camera is turned off. By saving current setting values to user memory, you can load and recall them whenever necessary. You can save up to three sets of user settings in the camera. (User Set1 to 3)

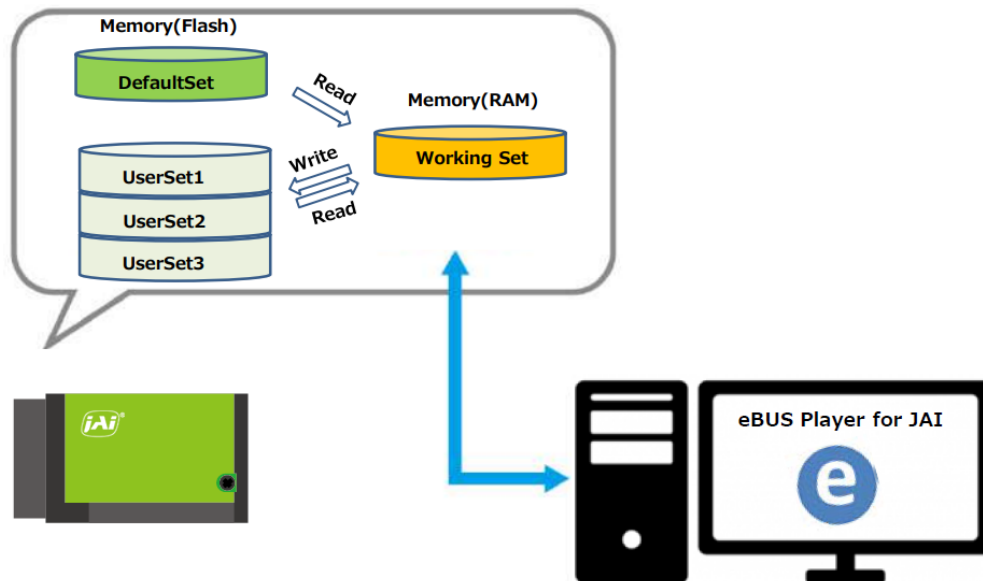

Notes:

- Changes to settings are not saved to the computer (eBUS SDK for JAI).
- The camera has non-volatile memory for users to store data. However, JAI strongly recommends saving images to the PC or other storage location because the non-volatile flash memory may not have enough memory size to store large data.

To Save User Settings

1. Stop image acquisition.
2. Expand **UserSetControl** and select the save destination (UserSet1 to UserSet3) in UserSetSelector.

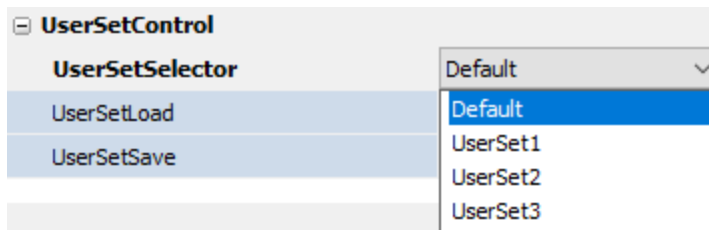

Note: The factory default setting values are stored in Default and cannot be overwritten.

Caution: Settings can only be saved when image acquisition on the camera is stopped.

3. Select **UserSetSave** and click the **UserSetSave** button.

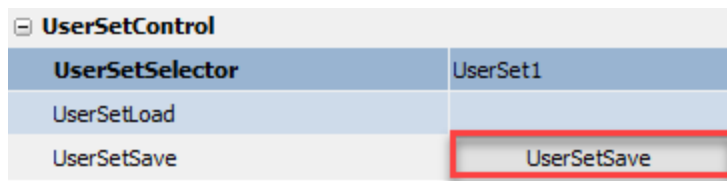

4. The current setting values are saved as user settings.

To Load User Settings

1. Stop image acquisition. User settings can only be loaded when image capture on the camera is stopped.
2. Select the settings to load (UserSet1 to UserSet3) in UserSetSelector.

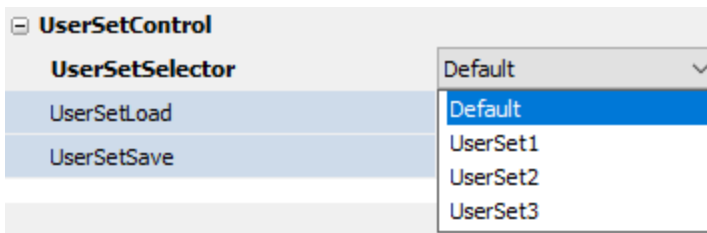

3. Select **UserSetLoad** and click the **UserSetLoad** button.

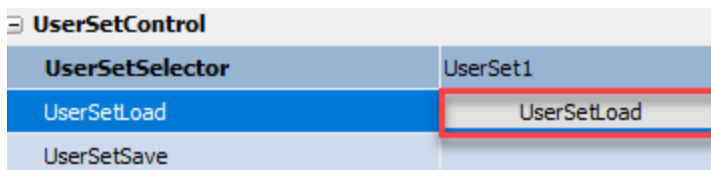

4. The selected user settings are loaded.

Note: When selecting **Default** for UserSetSelector, the factory settings are loaded.

Main Functions

This chapter describes the camera's main functions.

Acquisition Control

Related Setting Items: [AcquisitionControl](#)

This camera has three Acquisition modes (SingleFrame, MultiFrame, Continuous). Use the AcquisitionControl settings to perform operations and settings for image capture.

SingleFrame

When the AcquisitionStart command is executed, one frame of image is captured.



MultiFrame

When the AcquisitionStart command is executed, the number of frames set in AcquisitionFrameCount are acquired as images.

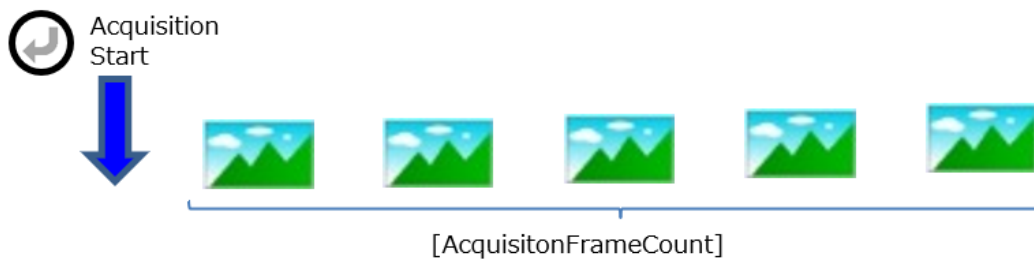

Continuous

When the AcquisitionStart command is executed, images will continue to be acquired until the AcquisitionStop command is executed.



Note: After changing various settings, the black level may not be stable for several frames immediately after AcquisitionStart.

Changing the Frame Rate

When TriggerMode is disabled, you can change the frame rate in AcquisitionFrameRate.

The shortest frame period varies depending on the Width, Height, PixelFormat, SensorDigitizationBits, Binning (Horizontal/Vertical), FD2x2BinningMode, ImageScalingMode, Decimation (Horizontal/Vertical), ChunkModeActive, GevSCPSPacketSize, GevSCPD, GevGVSPExtendedIDMode, NetworkThroughputSafetyMargin settings.

The NetworkThroughputSafetyMargin setting (in [TransportLayerControl](#)) controls how much of the available GigE Vision bandwidth can be used to transmit image data. The default value is 92 (percent). You can shorten the frame period (increase the frame rate) by increasing this value, however at values above 92, abnormal images may be observed. If abnormal images are observed, lower the value.

The longest frame period is 0.125 Hz (8 sec.).

Note: When TriggerMode[FrameStart] is enabled, the AcquisitionFrameRate setting is disabled except when [Image Compression Mode \(Xpress\)](#) is set to **Lossless**. For more information on the frame rate when in Image Compression Mode, see [Configure the Acquisition Frame Rate](#).

Exposure Mode

Related Setting Items: [AcquisitionControl](#)

This camera has three Exposure modes (Off, Timed, TriggerWidth). Use the AcquisitionControl settings to perform operations and settings for exposure.

■ ExposureMode = Off

Exposure control is not performed (free-running operation). The exposure time is the longest possible time within the operating conditions such as the frame rate.

■ ExposureMode = Timed

Mode in which control is performed using ExposureTime. Acquire images using an exposure time configured beforehand on an external trigger.

In this mode, the exposure time can be adjusted automatically by setting ExposureAuto. For details, refer to [ALC \(Automatic Level Control\) Function](#).

■ ExposureMode = TriggerWidth

Mode in which control of the exposure time is performed using the pulse width of the trigger input signal. The exposure time will be the same as the pulse width of the trigger input signal.

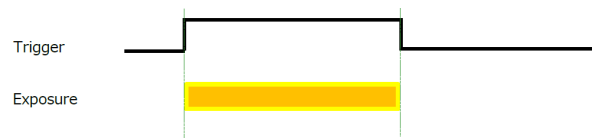

Notes:

- The settings for exposure control and triggers are related to each other. Be sure to configure the settings described in [Trigger Control](#).
- When exposed to strong light, the accumulation time may appear to shift due to PLS (Parasitic Light Sensitivity) and other effects.

Actual Exposure Time

Related Setting Items: [AcquisitionControl](#)

When ExposureMode is set to **Timed**, the actual exposure time will consist of the image sensor's offset duration (2.45us) added to the ExposureTime setting configured on the camera.

Actual Exposure Time: *ExposureTime* value (us) + 2.45us

Note: On this camera, the ExposureActive signal's pulse width includes the Exposure offset duration (2.45us). Therefore, "ExposureActive signal's pulse width = *ExposureTime* value (us) + 2.45(us)."

RCT Mode

Related Setting Items: [AcquisitionControl](#)

In RCT mode, the image is not output from the camera until FrameStartTrigger is input, but internally the imaging operation is continued and the automatic gain control (AGC) function, the automatic shutter control (ASC) function and the automatic white balance (AWB) function can be continued.

You can use RCT mode when:

- **ExposureMode** is set to **Timed**, and **FrameStartTrigger** is set to **On**.
- [Sequencer Function](#) = **Off**
- **AcquisitionMode** = **Continuous**

Burst Trigger Mode

Related Setting Items: [AcquisitionControl](#)

In Burst Trigger mode, when a single external trigger signal is received, the camera acquires images continuously at high speed, stores the images in the internal memory temporarily, and then the image data is read out. Data readout is limited to GigE Vision's readout speed (up to 1 Gbps).

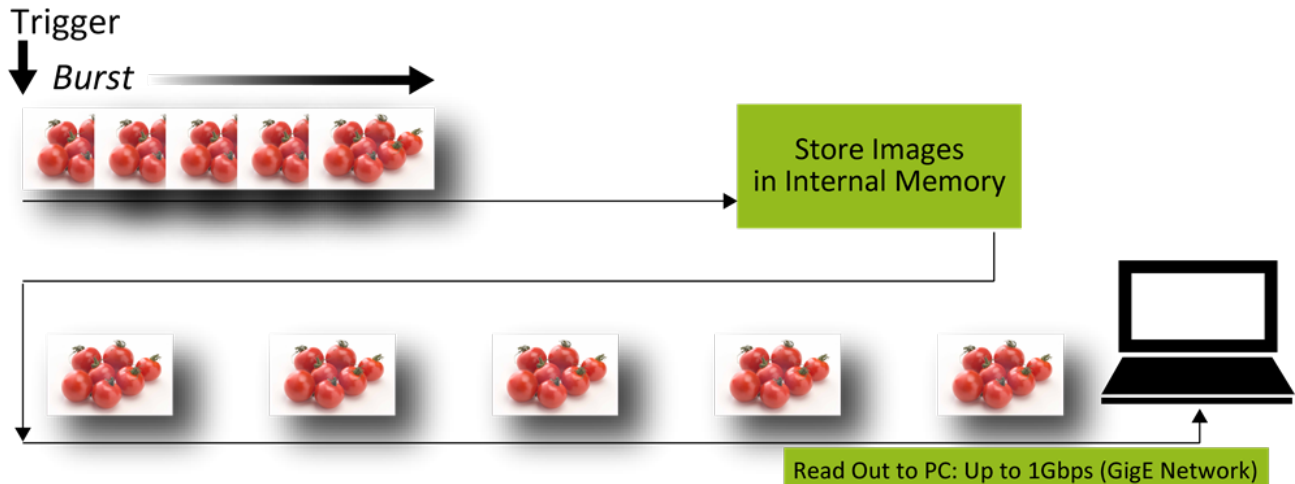

You can use BurstTrigger mode when:

- One or both of the following trigger modes is enabled:
 - **ExposureMode** is set to **Timed**, and **FrameStartTrigger** is set to **On**
 - **TriggerMode[AcquisitionStart]** = **On**
- [Image Compression Mode \(Xpress\)](#) = **Off**
- **GainAuto**, **ExposureAuto**, **BalanceWhiteAuto** are all set to **Off**

Notes:

- If **BurstTrigger[ExposureModeOption]** is set to **On** from **Off** or **RCT**, **GainAuto**, **ExposureAuto** and **BalanceWhiteAuto** will be forced **Off**.
- When in Burst Trigger mode, **PerformShadingCalibration**, **GainAuto**, **ExposureAuto**, and **BalanceWhiteAuto** cannot be controlled.

Max Frame Rate for Burst Trigger Mode

The maximum frame rate value for BurstTrigger mode is the maximum frame memory write speed (up to 6 Gbps) or the sensor maximum frame rate, whichever is slower.

Number of Frames That Can Be Acquired in Burst Trigger Mode

In BurstTrigger mode, all acquired frames cannot be output because the maximum frame rate for BurstTrigger mode is higher than the GigE bandwidth frame rate. Therefore, the number of frames that can be acquired in BurstTrigger mode is defined by the number of frames that can be stored in the camera's internal memory.

The number of frames that can be acquired depends on the model and SensorDigitizationBits setting. For example, if you are using GOX-5105C-PGE and SensorDigitizationBits is set to 10Bits, the maximum number of frames that can be acquired is 32.

Note: The number of frames in the table below are fixed values, regardless of the ROI size.

Number of Frames That Can Be Acquired

	SensorDigitizationBits		
	8Bits	10Bits	12Bits
GOX-5105MC-PGE	32 frames	32 frames	27 frames
GOX-8105MC-PGE	24 frames	19 frames	16 frames
GOX-12405MC-PGE	16 frames	13 frames	11 frames
GOX-16205MC-PGE	13 frames	10 frames	8 frames
GOX-20405MC-PGE	10 frames	8 frames	6 frames
GOX-24505MC-PGE	8 frames	7 frames	5 frames

Burst Trigger Mode Usage Examples

Burst Trigger Mode usage examples are shown below:

Example 1: Use MultiFrame Mode with AcquisitionStart Trigger

In this example, the number of frames to be acquired is defined by **AcquisitionFrameCount**, and the frame rate is defined by **AcquisitionFrameRate**.

Settings:

- AcquisitionMode = MultiFrame
- AcquisitionFrameCount = Any (see **Limitations**)
- TriggerMode[FrameStart] = Off
- TriggerMode[AcquisitionStart] = On

Limitations: For the frame count limitations, see the table above.

■ Example 2: Use Continuous Mode with FrameStart Trigger

In this example, the number of frames to be acquired is defined by the number of **FrameStart** triggers, and the frame rate is defined by the input trigger signal's interval.

Settings:

- AcquisitionMode = Continuous
- TriggerMode[FrameStart] = On

Limitations: When the frame buffer is full, trigger signal inputs will be masked. If ExposureTime is longer than BurstTrigger mode's minimum frame period, the trigger signal will also be masked.

■ Example 3: In Addition to Example 2, Use TriggerSequencer Mode

In this example, the number of frames to be acquired is defined by the number of **FrameStart** triggers, and the frame rate is defined by the input trigger signal's interval. When used together with TriggerSequencerMode, the ROI, Gain, ExposureTime, and other settings can be changed at each frame.

- AcquisitionMode = Continuous
- TriggerMode[FrameStart] = On
- SequencerMode = On
- SequencerModeSelect = TriggerSequencerMode

Limitations: When the frame buffer is full, the configured index order will be skipped because trigger signal inputs will be masked. If ExposureTime is longer than BurstTrigger mode's minimum frame period, the trigger signal will also be masked.

Trigger Control

Related Setting Items: [AcquisitionControl](#)

The camera allows the following controls to be performed via external trigger signals.

TriggerSelector	Description
AcquisitionStart	Start image acquisition in response to the external trigger signal input.
AcquisitionEnd	Stop image acquisition in response to the external trigger signal input.
FrameStart	Start capturing a one-frame image in response to the external trigger signal input. Select this to perform exposure control using external triggers. Note: The FrameStart Trigger can only be used when the Exposure Mode setting is set to Timed or TriggerWidth .
AcquisitionTransferStart	Start output of acquired image data in response to external trigger signal input (delayed readout). Note: See the Burst Trigger Mode topic for the number of frames that can be acquired on each model.

Notes:

- The settings for exposure control and triggers are related to each other. Be sure to configure the settings described in [Exposure Mode](#).
- You can delay when exposure actually starts after a trigger is received for a specific amount of time by configuring **TriggerDelay**.

Select the trigger type with TriggerSelector and set the following items for each trigger.

TriggerMode	Switch enable or disable.
TriggerSource	Select the source signal (PulseGenerator0-3, UserOutput0-3, Action0-3, Software, Line5 Opt In, Nand0 Out, Nand1 Out). Note: Trigger can be executed by TriggerSoftware[TriggerSelector] command only when Software is set.
TriggerActivation	Sets the polarity of the trigger signal.
TriggerDelay	You can specify a delay after receiving the trigger signal until the trigger is enabled. Note: This trigger type is available only when TriggerSelector is set to FrameStart .

When Using the FrameStart Trigger

When AcquisitionStart is executed and a FrameStart trigger is received before the AcquisitionStop command is executed, one frame is acquired.

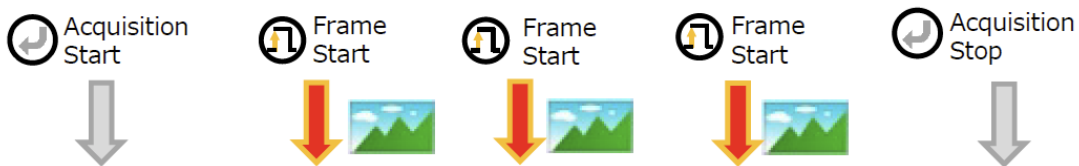

The source signals that can be set for the AcquisitionStart, AcquisitionEnd, FrameStart, and AcquisitionTransferStart triggers are as follows:

- Software, PulseGenerator 0 – 3, UserOutput 0 – 3, Action 0 – 3, Line5 Opt In 1, NAND0 Out, and NAND1 Out.

Pixel Format

Related Setting Items: [ImageFormatControl](#)



Technical Notes

Pixel Format Alignments for GigE Vision

Selectable PixelFormat is as follows.

Color models	<p>BayerRG8 (default), BayerRG10, BayerRG10Packed, BayerRG12, BayerRG12Packed, BayerGR8*, BayerGR10*, BayerGR10Packed*, BayerGR12*, BayerGR12Packed*, BayerGB8*, BayerGB10*, BayerGB10Packed*, BayerGB12*, BayerGB12Packed*, BayerBG8*, BayerBG10*, BayerBG10Packed*, BayerBG12*, BayerBG12Packed*, RGB8, RGB10V1Packed, RGB10p32</p> <p>Notes:</p> <ul style="list-style-type: none"> *When using ReverseX, ReverseY. RGB8, RGB10V1Packed, RGB10p32: Utilize 5x5 Debayering
Mono models	Mono8 (default), Mono10, Mono10Packed, Mono12, Mono12Packed

Notes:

On color models, the Bayer array is changed by the [Image Flip Function](#).

- ReverseX : 0 (False), ReverseY : 0 (False) -> BayerRG
- ReverseX : 0 (False), ReverseY : 1 (True) -> BayerGB
- ReverseX : 1 (True), ReverseY : 0 (False) -> BayerGR
- ReverseX : 1 (True), ReverseY : 1 (True) -> BayerBG

SensorDigitizationBits

Related Setting Items: [ImageFormatControl](#)

You can use SensorDigitizationBits to select the sensor output bits for this camera (8bits, 10bits, and 12bits: default = 10bits).

Notes:

- When SensorDigitizationBits is set to "8Bits", the sensitivity is 4 times higher than when set to 10Bits/12Bits.
- If SensorDigitizationBits is set to smaller than the pixel format bits configured in the [Pixel Format](#), the image may have gaps in histogram.
- When [Gradation Compression Mode](#) is set to On, SensorDigitizationBits is not configurable (maintains 10bits or 12bits).

Image Flip Function

Related Setting Items: [ImageFormatControl](#)

Using this function, you can output the image by inverting it horizontally and/or vertically.

In the ImageFormatControl settings,

- To reverse the image horizontally, set ReverseX to True.
- To reverse the image vertically, set ReverseY to True.

On color models, the Bayer array is changed by the Image Flip function.

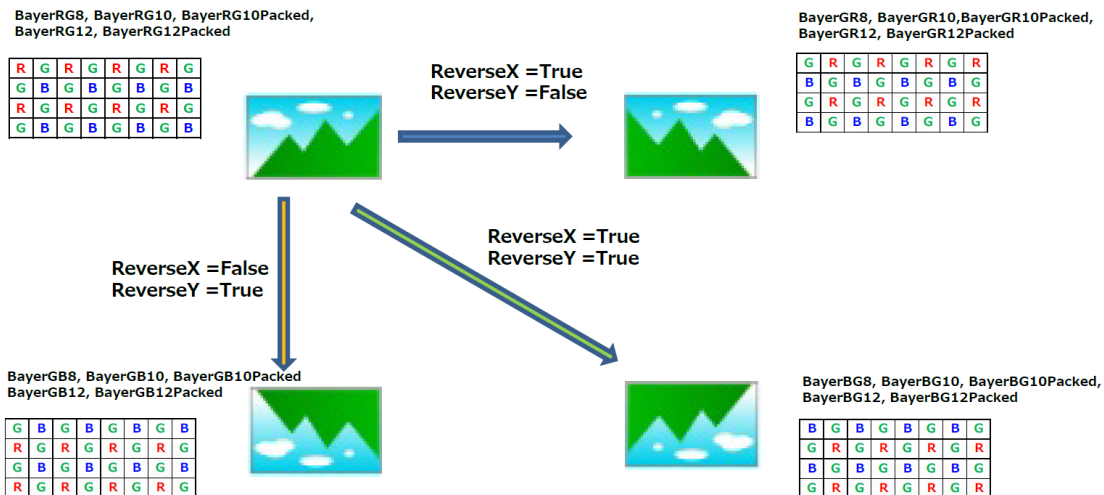

GPIO (Digital Input/Output Settings)

Related Setting Items: [DigitalIOControl](#)

The camera can input/output the following signals to and from external input/output connectors.

External Output	Line2 : Opt Out	DC IN / TRIG IN Connector (6-pin round)
Internal Output	Line5 : Opt In	DC IN / TRIG IN Connector (6-pin round)

These signals can be used as triggers and other necessary signals within the camera or as signals output from the camera to the system, such as those used for lighting equipment control.

Note: See [Recommended Circuit Diagram \(Reference Examples\)](#) for recommended external circuit examples.

Use the [DigitalIOControl](#) to set the digital input/output. Select input or output in LineSelector, you can check LineMode, LineFormat, and set LineInverter. You can also check the status of each digital I/O as shown in the table below with LineStatusAll.

LineSelector	LineMode	LineFormat	LineInverter	LineStatusAll	LineSource	
Line2 (Opt Output1)	Output	OptCoupled	True/False	bit1	Available (Default = Line5)	DC IN / TRG IN connector
Line5 (Opt In 2)	Input	OptCoupled	False (fixed)	bit4	Invalid	DC IN / TRG IN connector
Nand0In1	Input	InternalSignal	True/False	bit12	Available (Default = Line5)	
Nand0In2	Input	InternalSignal	True/False	bit13		
Nand1In1	Input	InternalSignal	True/False	bit14		
Nand1In2	Input	InternalSignal	True/False	bit15		
TimestampReset	Internal Connection	InternalSignal	False (fixed)		Available (Default = Off)	

For digital output, set the output source signal using LineSource. Set the source signal in the same way for NAND Logic (Nand0In1, Nand0In2, Nand1In1, NandIn2) and TimestampReset.

The table below shows the source signals that can be set.

LineSelector	Off	AcquisitionActive	FrameActive	ExposureActive	FVAL	LVAL	PulseGenerator0	PulseGenerator1	PulseGenerator2	PulseGenerator3	UserOutput0	UserOutput1	UserOutput2	UserOutput3	Action0	Action1	Action2	Action3	Lines Opt In1	NAND0 Out	NAND1 Out	Low	High	AcquisitionTriggerWait	FrameTriggerWait
Line2		✓	✓	✓	✓		✓	✓	✓	✓	✓	✓	✓	✓					✓	✓	✓	✓	✓	✓	✓
Line5																									
Nand0In1		✓	✓	✓	✓		✓	✓	✓	✓	✓	✓	✓	✓					✓		✓	✓	✓	✓	✓
Nand0In2		✓	✓	✓	✓		✓	✓	✓	✓	✓	✓	✓	✓					✓		✓	✓	✓	✓	✓
Nand1In1		✓	✓	✓	✓		✓	✓	✓	✓	✓	✓	✓	✓					✓	✓		✓	✓	✓	✓
Nand1In2		✓	✓	✓	✓		✓	✓	✓	✓	✓	✓	✓	✓					✓	✓		✓	✓	✓	✓
TimestampReset	✓						✓	✓	✓	✓	✓	✓	✓	✓	✓	✓	✓	✓	✓	✓	✓	✓	✓		

VideoProcessBypassMode

Related Setting Items: [ImagingControl](#)

The video process bypass mode is a function that bypasses internal video processing on the camera. To use this function, VideoProcessBypassMode must be set to On.

Functions Unavailable in VideoProcessBypassMode

Gain[DigitalRed][DigitalBlue], BlackLevel, BalanceWhiteAuto, LUTMode, ColorTransformationControl, EdgeEnhancer, ColorEnhancer, ShadingControl, SequencerGainDigitalRed/Blue, SequencerLutEnable

Calculate the Maximum Frame or Trigger Rate (Approximate)

Related Setting Items: [AcquisitionControl](#)

This section describes how to calculate the maximum frame rate or the maximum trigger rate (approximate). First, calculate the H Period, then calculate the minimum frame period based on the H Period value, and finally calculate the maximum frame rate (when in Continuous mode) or maximum trigger rate (when in Trigger mode).

Notes:

- The frame rate calculated in this topic is an approximate value and may have a certain margin of error (approx. $\pm 0.2\%$).
- The following conditions are applied:
 - GevSCPD = 0 (default)
 - NetworkThroughputSafetyMargin = 92% (default)
 - GevGVSPExtendedIDMode = Off (default)
- The Frame Rate Calculator, which calculates the maximum frame rate or trigger rate, is available for download from the product page on the JAI website (www.jai.com).

1. Calculate the H Period

The H Period value can be calculated from the LineTime[clk] value, which is calculated using the IF_LINETIME, SENSOR_LINETIME, and VIDEO_LINETIME values.

IF_LINETIME, SENSOR_LINETIME, VIDEO_LINETIME

A. IF_LINETIME

First calculate SendTime from the Payload, PacketNum and Overhead values, then calculate IF_Hperiod from SendTime, and finally calculate IF_LINETIME from IF_Hperiod.

1. Calculate **Payload[Byte]**.

$$\text{Payload[Byte]} = \text{Width}(*1) \times \text{Height}(*1) \times (\text{PixelSize} / 8)$$

For **Width (*1)** and **Height (*1)**, if using a [Binning Function](#) (FD2x2BinningMode, BinningHorizontal/Vertical), or in [Image Scaling Mode \(Xscale\)](#) or [Decimation Mode](#), enter the Width and Height values "**after**" configuring the settings.

Select the **PixelFormat** value from the table below based on your PixelFormat setting.

PixelFormat		PixelSize
Mono8	BayerRG8	8
Mono10, Mono12	BayerRG10, BayerRG12	16
Mono10Packed, Mono12Packed	BayerRG10Packed, BayerRG12Packed	12
-	RGB8	24
-	RGB10VPacked, RGB10p32	32

2. Calculate **PacketNum** from the Payload value.

$$\text{PacketNum} = \text{Roundup}(\text{Payload}[\text{Byte}] / (\text{GevSCPSPacketSize} - 36) + 2, 0)$$

3. Calculate **Overhead[Byte]** from the PacketNum value.

$$\text{Overhead}[\text{Byte}] = 44 + (74 \times (\text{PacketNum} + 2))$$

4. Calculate **SendTime[us]** from the Payload, PacketNum, and Overhead values.

$$\text{SendTime}[\text{us}] = \text{Rounddown}(\frac{((\text{Payload}[\text{Byte}] + \text{Overhead}[\text{Byte}]) \times 1000 / 115[\text{MB}] + (\text{PacketNum} \times 32))}{1000}, 0)$$

5. Calculate **IF_Hperiod[us]** from the SendTime value.

$$\text{IF_Hperiod}[\text{us}] = \text{SendTime}[\text{us}] / (\text{Height}(*1) + 1)$$

Height(*1): If using a [Binning Function](#) (FD2x2BinningMode, BinningVertical), or in [Image Scaling Mode \(Xscale\)](#) or [Decimation Mode](#), enter the Height value "after" configuring the settings.

6. Calculate **IF_LINETIME[clk]** from the IF_Hperiod value.

$$\text{IF_LINETIME}[\text{clk}] = \text{Round}(\text{IF_Hperiod}[\text{us}] \times 74.25[\text{MHz}] + 1, 0)$$

B. SENSOR_LINETIME[clk]

$$\text{SENSOR_LINETIME[clk]} = \text{HMAX}$$

Select the **HMAX** value from the table below based on the Sensor Operation, the SensorDigitizationBits setting, and your camera model.

Sensor Operation	Sensor Digitization Bits	GOX-5105		GOX-8105		GOX-12405		GOX-16205		GOX-20405		GOX-24505	
		Mono	Color	Mono	Color	Mono	Color	Mono	Color	Mono	Color	Mono	Color
Normal Mode	8Bit	270		270		344		447		375		447	
	10Bit	274		302		429		549		469		549	
	12Bit	408		408		511		655		557		655	
FD2x2BinningMode or DecimationMode	8Bit	135	270	135	270	183	270	230	290	199	290	230	290
	10Bit	142	284	158	284	222	284	285	302	245	302	285	302
	12Bit	204	408	204	408	264	408	339	418	287	418	339	418

C. VIDEO_LINETIME[clk]

$$\text{VIDEO_LINETIME[clk]} = \text{Roundup}((\text{Width}(*1) / 2) + 4) / 156.25 \times 74.25, 0)$$

For **Width(*1)**, enter the following value if using a Binning Function or in Image Scaling Mode (Xscale) or Decimation Mode.

- When **BinningHorizontal** is set to **2** or **ImageScalingMode** is set to **On**, enter the Width value "**before**" configuring the Binning or Image Scaling Mode settings.
- When **FD2x2BinningMode** is turned **On**, or **DecimationHorizontal** is set to **2**, enter the Width value "**after**" configuring the FD2x2Binning or Decimation Mode settings.

LineTime[clk]

Next, calculate the LineTime[clk] value using the IF_LINETIME, SENSOR_LINETIME, and VIDEO_LINETIME values.

$$\text{LineTime[clk]} = \text{MAX}(\text{IF_LINETIME[clk]}, \text{SENSOR_LINETIME[clk]}, \text{VIDEO_LINETIME[clk]})$$

H Period

Finally, calculate the **H Period** based on the above LineTime[clk] value.

$$\text{H Period[us]} = \text{LineTime[clk]} / 74.25[\text{MHz}]$$

2. Calculate the Minimum Frame Period

Next, calculate the Minimum Frame Period value that is `SensorMinimumFramePeriod[us]` or `FrameMemoryMinimumFramePeriod[us]`, whichever is larger.

1. Calculate `SensorMinimumFramePeriod[us]`.

$$\text{SensorMinimumFramePeriod[us]} = \text{Rounddown}(\text{SENSOR_LINETIME[clk]} / 74.25) \times (\text{Height}(*1) + \text{VBlanking} + 2), 0)$$

For **Height(*1)**, enter the following value if using the [Binning Function](#) or in [Image Scaling Mode \(Xscale\)](#) or [Decimation Mode](#).

- When **BinningVertical** is set to **2** or **ImageScalingMode** is set to **On**, enter the Height value "**before**" configuring the Binning or Image Scaling Mode settings.
- When **FD2x2BinningMode** is turned **On**, or **DecimationVertical** is set to **2**, enter the Height value "**after**" configuring the FD2x2Binning or Decimation Mode settings.

Select the **VBlanking** value from the table below based on the Sensor Operation, the [SensorDigitizationBits](#) setting, and your camera model.

Sensor Operation	Sensor DigitizationBits	GOX-5105		GOX-8105		GOX-12405		GOX-16205		GOX-20405		GOX-24505	
		Mono	Color	Mono	Color	Mono	Color	Mono	Color	Mono	Color	Mono	Color
Normal Mode	8Bit	172		172		152		118		124		118	
	10Bit	152		164		142		112		116		112	
	12Bit	144		144		130		110		112		110	
FD2x2BinningMode or DecimationMode	8Bit	258	172	258	172	214	172	144	132	152	132	144	132
	10Bit	246	166	234	166	190	166	136	130	144	130	136	130
	12Bit	202	144	202	144	174	144	128	120	136	120	128	120

2. Calculate `FrameMemoryMinimumFramePeriod[us]`.

$$\text{FrameMemoryMinimumFramePeriod[us]} = \text{Rounddown}(\text{HPeriod[us]} \times (\text{Height}(*1) + 30), 0)$$

For **Height(*1)**, enter the following value if using the [Binning Function](#) or in [Image Scaling Mode \(Xscale\)](#) or [Decimation Mode](#).

- When **BinningVertical** is set to **2** or **ImageScalingMode** is set to **On**, enter the Height value "**before**" configuring the Binning or Image Scaling Mode settings.

- When **FD2x2BinningMode** is turned **On**, or **DecimationVertical** is set to **2**, enter the Height value "**after**" configuring the FD2x2Binning or Decimation Mode settings.

3. Calculate **Minimum Frame Period[us]**.

$$\text{Minimum Frame Period[us]} = \text{MAX}(\text{SensorMinimumFramePeriod[us]}, \text{FrameMemoryMinimumFramePeriod[us]})$$

3. Calculate the Maximum Frame Rate or Maximum Trigger Rate

Finally, calculate the maximum acquisition frame rate (when in Continuous Mode) or maximum trigger rate (when in Trigger Mode).

Maximum Acquisition Frame Rate (Continuous Mode: FrameStart Trigger = Off)

$$\text{Maximum Acquisition Frame Rate[Hz]} = 1000000 / \text{Minimum Frame Period[us]}$$

Maximum Trigger Rate (Trigger Mode: FrameStart Trigger = On)

First, calculate the Maximum Overlap Time value for the shortest trigger period.

$$\text{MaxOverlapTime_TrOlr}[us] = \text{Minimum Frame Period[us]} - (\text{Non-ExposurePeriod[H]} \times \text{H Period[us]})$$

Select the **Non-ExposurePeriod[H]** value from the table below based on the Sensor Operation, the **SensorDigitizationBits** setting, and your camera model.

Sensor Operation	Sensor DigitizationBits	GOX-5105		GOX-8105		GOX-12405		GOX-16205		GOX-20405		GOX-24505	
		Mono	Color	Mono	Color	Mono	Color	Mono	Color	Mono	Color	Mono	Color
Normal Mode	8Bit	70		70		56		24		26		24	
	10Bit	66		64		48		20		22		20	
	12Bit	50		50		40		20		20		20	
FD2x2BinningMode or DecimationMode	8Bit	132	70	132	70	100	70	36	30	40	30	36	30
	10Bit	124	66	116	66	84	66	32	28	36	28	32	28
	12Bit	92	50	92	50	72	50	28	24	32	24	28	24

Next, calculate the Maximum Trigger Rate. The formula depends on whether the Exposure Time value is longer or shorter than the MaxOverlapTime_TrOIRD value.

A. When ExposureTime \leq MaxOverlapTime_TrOIRD[us]

$$\text{Maximum Trigger Rate[Hz]} = \text{Maximum Acquisition Frame Rate[Hz]}$$

B. When ExposureTime > MaxOverlapTime_TrOIRD[us]

First, calculate the Non-OverlapExposureTime_TrOIRD[us] value.

$$\text{Non-OverlapExposureTime_TrOIRD[us]} = \text{ExposureTime} - \text{MaxOverlapTime_TrOIRD[us]}$$

Finally, calculate the Maximum Trigger Rate.

$$\text{Maximum Trigger Rate[Hz]} = 1000000 / (\text{Minimum Frame Period[us]} + \text{Non-OverlapExposureTime_TrOIRD[us]})$$

Timing Chart

Related Setting Items: [AcquisitionControl](#)

This section shows the timing charts under the following conditions on each model when FrameStartTriger is set to **On**.

- [Exposure Mode = Timed \(Overlap Readout\)](#)
- [Exposure Mode = TriggerWidth \(Overlap Readout\)](#)
- [Exposure Mode = Timed \(RCT Mode\)](#)

Notes:

- The values on the timing charts were measured with the following settings:
 - GevSCPSPacketSize: Max(12036Byte)
 - GevSCPD: Min(0)
 - GevGVSPExtendedIDMode: Off
 - NetworkThroughputSafetyMargin: 100%
- On this camera, the ExposureActive signal's pulse width includes the Exposure offset duration (2.45us). Therefore, "ExposureActive signal's pulse width = ExposureTime value (us) + 2.45(us)," or in the case of TriggerWidth operation "ExposureActive signal's pulse width = Trigger Signal's Effective Pulse Width (us) + 2.45(us)."

Exposure Mode = Timed (Overlap Readout)

This section shows the timing charts when FrameStartTrigger is set to **On**, and ExposureMode is set to **Timed** (Overlap Readout).

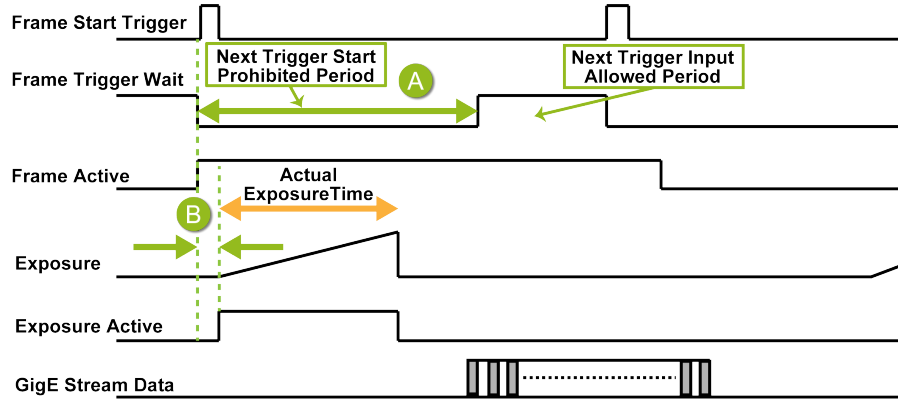

A	Frame Period (usec)
B	Period From Trigger Start Edge to Exposure Start (usec)

GOX-5105M-PGE, GOX-5105C-PGE**■ Exposure Mode = Timed (Frame Start Trigger On, Overlap Readout)**

Pixel Format	Frame Period [A] usec	Period From Trigger Start Edge to Exposure Start [B] (usec)
Full (Max Frame Rate)		
Mono8	41153	96.5
Mono10, Mono12	83334	96.6
Mono10Packed, Mono12Packed	62112	96.4
BayerRG8	41153	96.5
BayerRG10, BayerRG12	83334	96.6
BayerRG10Packed, BayerRG12Packed	62112	96.4
RGB8	125000	98.2
RGB10V1Packed, RGB10p32	166667	98.2
Binning Horizontal (Max Frame Rate)		
Mono8	20790	96.5
Mono10, Mono12	41323	96.5
Mono10Packed, Mono12Packed	30960	96.5
Binning Vertical (Max Frame Rate)		
Mono8	41323	96.5
Mono10, Mono12	83334	96.6
Mono10Packed, Mono12Packed	62112	96.4
Binning Horizontal & Binning Vertical (Max Frame Rate)		
Mono8	20747	96.6
Mono10, Mono12	41494	96.5
Mono10Packed, Mono12Packed	31056	96.6

GOX-8105M-PGE, GOX-8105C-PGE**Exposure Mode = Timed (Frame Start Trigger On, Overlap Readout)**

Pixel Format	Frame Period [A] usec	Period From Trigger Start Edge to Exposure Start [B] (usec)
Full (Max Frame Rate)		
Mono8	65790	111.4
Mono10, Mono12	133334	111.7
Mono10Packed, Mono12Packed	99010	111.2
BayerRG8	65790	111.4
BayerRG10, BayerRG12	133334	111.7
BayerRG10Packed, BayerRG12Packed	99010	111.2
RGB8	200002	113.4
RGB10V1Packed, RGB10p32	270273	113.4
Binning Horizontal (Max Frame Rate)		
Mono8	32895	111.6
Mono10, Mono12	65790	111.6
Mono10Packed, Mono12Packed	49505	111.6
Binning Vertical (Max Frame Rate)		
Mono8	65790	111.6
Mono10, Mono12	133334	111.7
Mono10Packed, Mono12Packed	99010	111.2
Binning Horizontal & Binning Vertical (Max Frame Rate)		
Mono8	32895	111.6
Mono10, Mono12	66225	111.6
Mono10Packed, Mono12Packed	49505	111.6

GOX-12405M-PGE, GOX-12405C-PGE**Exposure Mode = Timed (Frame Start Trigger On, Overlap Readout)**

Pixel Format	Frame Period [A] usec	Period From Trigger Start Edge to Exposure Start [B] (usec)
Full (Max Frame Rate)		
Mono8	109890	136.4
Mono10, Mono12	222223	136.8
Mono10Packed, Mono12Packed	166667	136.8
BayerRG8	109890	136.4
BayerRG10, BayerRG12	222223	136.8
BayerRG10Packed, BayerRG12Packed	166667	136.8
RGB8	303033	136.8
RGB10V1Packed, RGB10p32	416670	136.8
Binning Horizontal (Max Frame Rate)		
Mono8	54945	136.8
Mono10, Mono12	109891	136.4
Mono10Packed, Mono12Packed	82645	136.6
Binning Vertical (Max Frame Rate)		
Mono8	109890	136.4
Mono10, Mono12	222223	136.8
Mono10Packed, Mono12Packed	166667	136.8
Binning Horizontal & Binning Vertical (Max Frame Rate)		
Mono8	54945	136.8
Mono10, Mono12	109890	136.4
Mono10Packed, Mono12Packed	82645	136.6

GOX-16205M-PGE, GOX-16205C-PGE**Exposure Mode = Timed (Frame Start Trigger On, Overlap Readout)**

Pixel Format	Frame Period [A] usec	Period From Trigger Start Edge to Exposure Start [B] (usec)
Full (Max Frame Rate)		
Mono8	131579	144.0
Mono10, Mono12	263159	144.5
Mono10Packed, Mono12Packed	200000	144.5
BayerRG8	131579	144.0
BayerRG10, BayerRG12	263159	144.5
BayerRG10Packed, BayerRG12Packed	200000	144.5
RGB8	400003	144.5
RGB10V1Packed, RGB10p32	526320	144.5
Binning Horizontal (Max Frame Rate)		
Mono8	65360	144.0
Mono10, Mono12	131579	144.1
Mono10Packed, Mono12Packed	99010	144.5
Binning Vertical (Max Frame Rate)		
Mono8	131579	144.0
Mono10, Mono12	263159	144.5
Mono10Packed, Mono12Packed	200001	144.5
Binning Horizontal & Binning Vertical (Max Frame Rate)		
Mono8	65360	143.8
Mono10, Mono12	131580	144.1
Mono10Packed, Mono12Packed	99010	144.5

GOX-20405M-PGE, GOX-20405C-PGE**Exposure Mode = Timed (Frame Start Trigger On, Overlap Readout)**

Pixel Format	Frame Period [A] usec	Period From Trigger Start Edge to Exposure Start [B] (usec)
Full (Max Frame Rate)		
Mono8	166668	122.5
Mono10, Mono12	333336	122.5
Mono10Packed, Mono12Packed	250002	122.5
BayerRG8	166668	122.5
BayerRG10, BayerRG12	333336	122.5
BayerRG10Packed, BayerRG12Packed	250002	122.5
RGB8	500004	146.9
RGB10V1Packed, RGB10p32	659432	146.9
Binning Horizontal (Max Frame Rate)		
Mono8	82645	122.4
Mono10, Mono12	166668	122.5
Mono10Packed, Mono12Packed	123458	1220
Binning Vertical (Max Frame Rate)		
Mono8	166668	122.5
Mono10, Mono12	333336	122.5
Mono10Packed, Mono12Packed	250002	122.5
Binning Horizontal & Binning Vertical (Max Frame Rate)		
Mono8	82645	122.4
Mono10, Mono12	166668	122.6
Mono10Packed, Mono12Packed	123458	122.4

GOX-24505M-PGE, GOX-24505C-PGE**Exposure Mode = Timed (Frame Start Trigger On, Overlap Readout)**

Pixel Format	Frame Period [A] usec	Period From Trigger Start Edge to Exposure Start [B] (usec)
Full (Max Frame Rate)		
Mono8	200000	144.5
Mono10, Mono12	400001	144.5
Mono10Packed, Mono12Packed	303031	144.5
BayerRG8	200000	144.5
BayerRG10, BayerRG12	400001	144.5
BayerRG10Packed, BayerRG12Packed	303031	144.5
RGB8	596304	144.5
RGB10V1Packed, RGB10p32	795292	144.5
Binning Horizontal (Max Frame Rate)		
Mono8	99010	143.6
Mono10, Mono12	200000	144.1
Mono10Packed, Mono12Packed	149254	143.6
Binning Vertical (Max Frame Rate)		
Mono8	200000	144.5
Mono10, Mono12	400002	144.5
Mono10Packed, Mono12Packed	303031	144.5
Binning Horizontal & Binning Vertical (Max Frame Rate)		
Mono8	99010	143.6
Mono10, Mono12	200001	144.1
Mono10Packed, Mono12Packed	149254	144.0

Exposure Mode = TriggerWidth (Overlap Readout)

This section shows the timing charts when FrameStartTrigger is set to **On**, and ExposureMode is set to **TriggerWidth** (Overlap Readout).

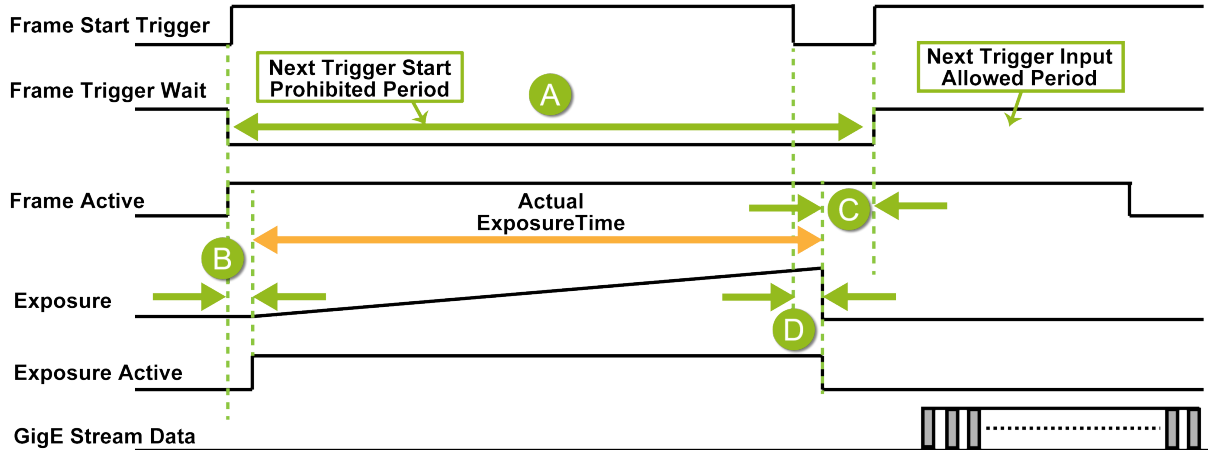

A	Frame Period (usec)
B	Period From Trigger Start Edge to Exposure Start (usec)
C	Period From Exposure End to Next Trigger Start (usec)
D	Period From Trigger End to Exposure End (usec) (= B + 2.45 usec)

In TriggerWidth mode, the frame period specified assumes the camera is operating with the BurstTrigger[Exposure Mode Option] On. This allows the sensor to temporarily operate at frame rates that exceed the GigE bandwidth, as long as there is space in the camera's memory to store them. When the memory limit is reached, additional frames are discarded and the image is output at the frame rate of the GigE bandwidth (see the Number of Frames That Can Be Acquired table in the [Burst Trigger Mode](#) topic).

In a use case where the number of frames that will be stored in the memory is within the frame count limitations, this option allows images to be acquired at a higher frame rate than when using Timed triggers. On the other hand, the maximum trigger rate for a "sustained frame rate" is the same as for Timed triggering.

GOX-5105M-PGE, GOX-5105C-PGE**■ Exposure Mode = TriggerWidth (Frame Start Trigger On, Overlap Readout)**

Pixel Format	Frame Period [A] (usec)	Period From Trigger Start Edge to Exposure Start [B] (usec)	Period from Exposure End to Next Trigger Start [C] (usec)
Full (Max Frame Rate), Maximum Exposure Time in Max Frame Rate			
Mono8	16386	96.5	371.0
Mono10, Mono12	16386	96.4	371.0
Mono10Packed, Mono12Packed	16386	96.4	371.0
BayerRG8	16386	96.5	371.0
BayerRG10, BayerRG12	16386	96.4	371.0
BayerRG10Packed, BayerRG12Packed	16386	96.4	371.0
RGB8	16385	96.4	370.4
RGB10V1Packed, RGB10p32	16385	96.4	370.4
Binning Horizontal (Max Frame Rate), Maximum Exposure Time in Max Frame Rate			
Mono8	16386	96.5	371.0
Mono10, Mono12	16386	96.5	371.0
Mono10Packed, Mono12Packed	16386	96.5	371.0
Binning Vertical (Max Frame Rate), Maximum Exposure Time in Max Frame Rate			
Mono8	16386	96.5	371.0
Mono10, Mono12	16386	96.4	371.0
Mono10Packed, Mono12Packed	16386	96.4	371.0
Binning Horizontal & Binning Vertical (Max Frame Rate), Maximum Exposure Time in Max Frame Rate			
Mono8	16386	96.5	371.0
Mono10, Mono12	16386	96.5	371.0
Mono10Packed, Mono12Packed	16386	96.5	371.0

GOX-8105M-PGE, GOX-8105C-PGE**■ Exposure Mode = TriggerWidth (Frame Start Trigger On, Overlap Readout)**

Pixel Format	Frame Period [A] (usec)	Period From Trigger Start Edge to Exposure Start [B] (usec)	Period from Exposure End to Next Trigger Start [C] (usec)
Full (Max Frame Rate), Maximum Exposure Time in Max Frame Rate			
Mono8	25715	111.6	412.0
Mono10, Mono12	25714	111.0	412.0
Mono10Packed, Mono12Packed	25714	111.0	412.0
BayerRG8	25715	111.6	412.0
BayerRG10, BayerRG12	25714	111.0	412.0
BayerRG10Packed, BayerRG12Packed	25714	111.0	412.0
RGB8	30465	113.4	410.0
RGB10V1Packed, RGB10p32	30463	112.0	410.0
Binning Horizontal (Max Frame Rate), Maximum Exposure Time in Max Frame Rate			
Mono8	25715	111.8	412.0
Mono10, Mono12	25714	111.6	412.0
Mono10Packed, Mono12Packed	25715	111.6	412.0
Binning Vertical (Max Frame Rate), Maximum Exposure Time in Max Frame Rate			
Mono8	25714	111.6	412.0
Mono10, Mono12	25714	111.0	412.0
Mono10Packed, Mono12Packed	25715	111.0	412.0
Binning Horizontal & Binning Vertical (Max Frame Rate), Maximum Exposure Time in Max Frame Rate			
Mono8	25714	111.8	412.0
Mono10, Mono12	25714	111.6	412.0
Mono10Packed, Mono12Packed	25715	111.6	412.0

GOX-12405M-PGE, GOX-12405C-PGE**Exposure Mode = TriggerWidth (Frame Start Trigger On, Overlap Readout)**

Pixel Format	Frame Period [A] (usec)	Period From Trigger Start Edge to Exposure Start [B] (usec)	Period from Exposure End to Next Trigger Start [C] (usec)
Full (Max Frame Rate), Maximum Exposure Time in Max Frame Rate			
Mono8	38750	136.4	423.0
Mono10, Mono12	38730	136.0	423.0
Mono10Packed, Mono12Packed	38740	136.4	423.0
BayerRG8	38750	136.4	423.0
BayerRG10, BayerRG12	38730	136.0	423.0
BayerRG10Packed, BayerRG12Packed	38740	136.4	423.0
RGB8	38797	136.0	423.0
RGB10V1Packed, RGB10p32	38722	135.0	423.0
Binning Horizontal (Max Frame Rate), Maximum Exposure Time in Max Frame Rate			
Mono8	38840	136.6	423.0
Mono10, Mono12	38840	136.4	423.0
Mono10Packed, Mono12Packed	38840	136.6	423.0
Binning Vertical (Max Frame Rate), Maximum Exposure Time in Max Frame Rate			
Mono8	38840	136.4	423.0
Mono10, Mono12	38850	135.0	423.0
Mono10Packed, Mono12Packed	38940	136.8	423.0
Binning Horizontal & Binning Vertical (Max Frame Rate), Maximum Exposure Time in Max Frame Rate			
Mono8	38940	136.6	423.0
Mono10, Mono12	38970	136.4	423.0
Mono10Packed, Mono12Packed	38940	136.6	423.0

GOX-16205M-PGE, GOX-16205C-PGE**Exposure Mode = TriggerWidth (Frame Start Trigger On, Overlap Readout)**

Pixel Format	Frame Period [A] (usec)	Period From Trigger Start Edge to Exposure Start [B] (usec)	Period from Exposure End to Next Trigger Start [C] (usec)
Full (Max Frame Rate), Maximum Exposure Time in Max Frame Rate			
Mono8	49802	144.0	132.0
Mono10, Mono12	49804	143.0	132.0
Mono10Packed, Mono12Packed	49802	144.0	132.0
BayerRG8	49802	144.0	132.0
BayerRG10, BayerRG12	49804	143.0	132.0
BayerRG10Packed, BayerRG12Packed	49802	144.0	132.0
RGB8	59959	144.4	132.0
RGB10V1Packed, RGB10p32	59958	144.4	132.0
Binning Horizontal (Max Frame Rate), Maximum Exposure Time in Max Frame Rate			
Mono8	49952	144.4	132.0
Mono10, Mono12	49952	144.4	132.0
Mono10Packed, Mono12Packed	49952	144.0	132.0
Binning Vertical (Max Frame Rate), Maximum Exposure Time in Max Frame Rate			
Mono8	49952	144.0	132.0
Mono10, Mono12	49952	144.0	132.0
Mono10Packed, Mono12Packed	49952	144.0	132.0
Binning Horizontal & Binning Vertical (Max Frame Rate), Maximum Exposure Time in Max Frame Rate			
Mono8	50052	144.4	132.0
Mono10, Mono12	50055	144.4	132.0
Mono10Packed, Mono12Packed	50052	144.0	132.0

GOX-20405M-PGE, GOX-20405C-PGE**■ Exposure Mode = TriggerWidth (Frame Start Trigger On, Overlap Readout)**

Pixel Format	Frame Period [A] (usec)	Period From Trigger Start Edge to Exposure Start [B] (usec)	Period from Exposure End to Next Trigger Start [C] (usec)
Full (Max Frame Rate), Maximum Exposure Time in Max Frame Rate			
Mono8	62081	122.4	136.0
Mono10, Mono12	62071	122.0	136.0
Mono10Packed, Mono12Packed	62061	122.0	136.0
BayerRG8	62081	122.4	136.0
BayerRG10, BayerRG12	62071	122.0	136.0
BayerRG10Packed, BayerRG12Packed	62061	122.0	136.0
RGB8	74570	146.0	132.0
RGB10V1Packed, RGB10p32	74567	146.0	132.0
Binning Horizontal (Max Frame Rate), Maximum Exposure Time in Max Frame Rate			
Mono8	62211	122.4	136.0
Mono10, Mono12	62211	122.0	136.0
Mono10Packed, Mono12Packed	62231	122.4	136.0
Binning Vertical (Max Frame Rate), Maximum Exposure Time in Max Frame Rate			
Mono8	62261	122.0	136.0
Mono10, Mono12	62311	121.0	136.0
Mono10Packed, Mono12Packed	62311	121.0	136.0
Binning Horizontal & Binning Vertical (Max Frame Rate), Maximum Exposure Time in Max Frame Rate			
Mono8	62371	122.4	136.0
Mono10, Mono12	62311	122.4	136.0
Mono10Packed, Mono12Packed	62231	122.4	136.0

GOX-24505M-PGE, GOX-24505C-PGE**■ Exposure Mode = TriggerWidth (Frame Start Trigger On, Overlap Readout)**

Pixel Format	Frame Period [A] (usec)	Period From Trigger Start Edge to Exposure Start [B] (usec)	Period from Exposure End to Next Trigger Start [C] (usec)
Full (Max Frame Rate), Maximum Exposure Time in Max Frame Rate			
Mono8	74847	143.0	130.4
Mono10, Mono12	74867	143.0	130.4
Mono10Packed, Mono12Packed	74847	143.0	130.4
BayerRG8	74847	143.0	130.4
BayerRG10, BayerRG12	74867	143.0	130.4
BayerRG10Packed, BayerRG12Packed	74847	143.0	130.4
RGB8	74881	144.0	129.0
RGB10V1Packed, RGB10p32	74881	142.0	129.0
Binning Horizontal (Max Frame Rate), Maximum Exposure Time in Max Frame Rate			
Mono8	75000	144.0	130.4
Mono10, Mono12	75007	144.0	130.4
Mono10Packed, Mono12Packed	74997	144.4	130.4
Binning Vertical (Max Frame Rate), Maximum Exposure Time in Max Frame Rate			
Mono8	74999	144.0	130.4
Mono10, Mono12	74997	143.0	130.4
Mono10Packed, Mono12Packed	74997	144.0	130.4
Binning Horizontal & Binning Vertical (Max Frame Rate), Maximum Exposure Time in Max Frame Rate			
Mono8	75099	144.0	130.4
Mono10, Mono12	74997	143.0	130.4
Mono10Packed, Mono12Packed	75098	144.0	130.4

Exposure Mode = Timed (RCT Mode)

This section shows the timing charts when FrameStartTrigger is set to **On**, and ExposureMode is set to **Timed** (RCT Mode).

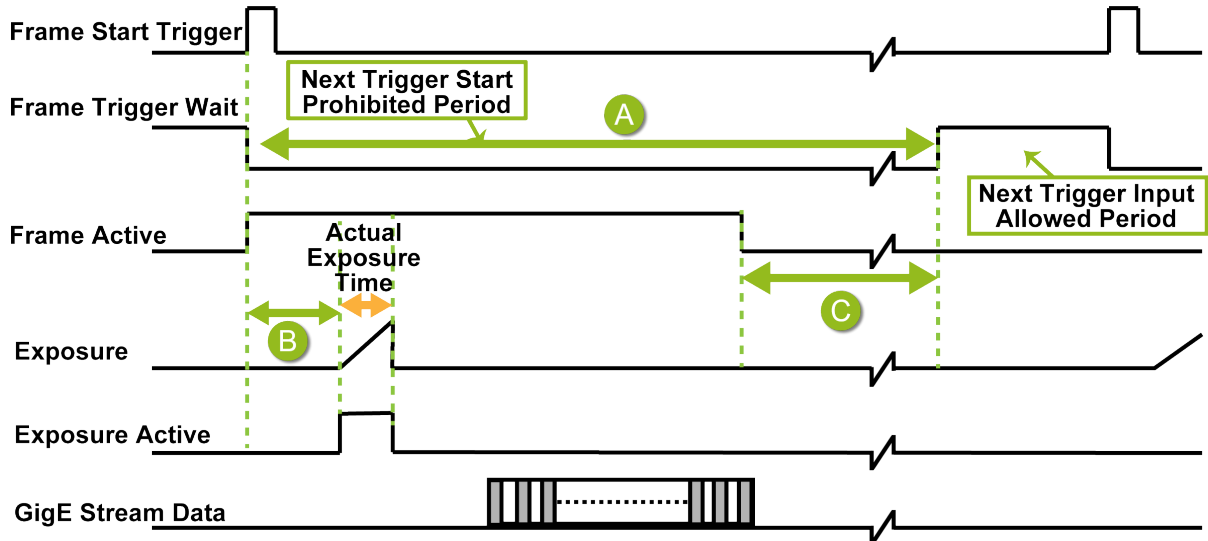

A	Frame Period (usec)
B	Period From Trigger Start Edge to Exposure Start (usec)
C	Data Invalid Period (usec)

GOX-5105M-PGE, GOX-5105C-PGE**Exposure Mode = Timed (Frame Start Trigger On, RCT Mode)**

Pixel Format	Frame Period [A] (usec)	Period From Trigger Start Edge to Exposure Start [B] (usec)	Data Invalid Period [C] (usec)
Full (Max Frame Rate), Exposure Time Minimum			
Mono8	103094	1861.9	59258
Mono10, Mono12	103094	1861.8	18301
Mono10Packed, Mono12Packed	103094	1861.9	38779
BayerRG8	103094	1861.9	59258
BayerRG10, BayerRG12	103094	1861.8	18301
BayerRG10Packed, BayerRG12Packed	103094	1861.9	38779
RGB8	126583	1863.4	686
RGB10V1Packed, RGB10p32	169492	1863.4	2645
Binning Horizontal (Max Frame Rate), Exposure Time Minimum			
Mono8	103094	1861.9	79684
Mono10, Mono12	103094	1861.9	59246
Mono10Packed, Mono12Packed	103094	1861.9	69465
Binning Vertical (Max Frame Rate), Exposure Time Minimum			
Mono8	103094	1861.9	59250
Mono10, Mono12	103094	1861.9	18319
Mono10Packed, Mono12Packed	103094	1861.9	38798
Binning Horizontal & Binning Vertical (Max Frame Rate), Exposure Time Minimum			
Mono8	103094	1861.9	79716
Mono10, Mono12	103094	1861.9	59237
Mono10Packed, Mono12Packed	103093	1861.8	69457

GOX-8105M-PGE, GOX-8105C-PGE**■ Exposure Mode = Timed (Frame Start Trigger On, RCT Mode)**

Pixel Format	Frame Period [A] (usec)	Period From Trigger Start Edge to Exposure Start [B] (usec)	Data Invalid Period [C] (usec)
Full (Max Frame Rate), Exposure Time Minimum			
Mono8	103093	1876.9	34750
Mono10, Mono12	135136	1876.9	1524
Mono10Packed, Mono12Packed	103093	1876.9	2115
BayerRG8	103093	1876.9	34750
BayerRG10, BayerRG12	135136	1876.9	1524
BayerRG10Packed, BayerRG12Packed	103093	1876.9	2115
RGB8	200002	1878.7	815
RGB10V1Packed, RGB10p32	270272	1878.7	5766
Binning Horizontal (Max Frame Rate), Exposure Time Minimum			
Mono8	103093	1877.0	67369
Mono10, Mono12	103093	1876.9	34735
Mono10Packed, Mono12Packed	103093	1876.9	51062
Binning Vertical (Max Frame Rate), Exposure Time Minimum			
Mono8	103093	1876.9	34776
Mono10, Mono12	103093	1877.0	1552
Mono10Packed, Mono12Packed	103093	1876.9	2143
Binning Horizontal & Binning Vertical (Max Frame Rate), Exposure Time Minimum			
Mono8	103093	1876.9	67397
Mono10, Mono12	103093	1876.9	34763
Mono10Packed, Mono12Packed	103093	1877.0	51052

GOX-12405M-PGE, GOX-12405C-PGE**Exposure Mode = Timed (Frame Start Trigger On, RCT Mode)**

Pixel Format	Frame Period [A] (usec)	Period From Trigger Start Edge to Exposure Start [B] (usec)	Data Invalid Period [C] (usec)
Full (Max Frame Rate), Exposure Time Minimum			
Mono8	112360	1902.1	199
Mono10, Mono12	222223	1902.1	1366
Mono10Packed, Mono12Packed	166667	1902.1	158
BayerRG8	112360	1902.1	199
BayerRG10, BayerRG12	222223	1902.1	1366
BayerRG10Packed, BayerRG12Packed	166667	1902.1	158
RGB8	312502	1902.1	9017
RGB10V1Packed, RGB10p32	405671	1902.1	2165
Binning Horizontal (Max Frame Rate), Exposure Time Minimum			
Mono8	103093	1902.1	45261
Mono10, Mono12	112360	1902.1	179
Mono10Packed, Mono12Packed	103093	1902.1	18087
Binning Vertical (Max Frame Rate), Exposure Time Minimum			
Mono8	112360	1902.1	224
Mono10, Mono12	222223	1902.1	1430
Mono10Packed, Mono12Packed	166667	1902.1	183
Binning Horizontal & Binning Vertical (Max Frame Rate), Exposure Time Minimum			
Mono8	103093	1902.1	45286
Mono10, Mono12	112360	1902.1	204
Mono10Packed, Mono12Packed	103093	1902.1	18112

GOX-16205M-PGE, GOX-16205C-PGE**■ Exposure Mode = Timed (Frame Start Trigger On, RCT Mode)**

Pixel Format	Frame Period [A] (usec)	Period From Trigger Start Edge to Exposure Start [B] (usec)	Data Invalid Period [C] (usec)
Full (Max Frame Rate), Exposure Time Minimum			
Mono8	133334	1909.8	-469
Mono10, Mono12	270271	1909.8	6154
Mono10Packed, Mono12Packed	200001	1909.8	1041
BayerRG8	133334	1909.8	-469
BayerRG10, BayerRG12	270271	1909.8	6154
BayerRG10Packed, BayerRG12Packed	200001	1909.8	1041
RGB8	400003	1909.8	5129
RGB10V1Packed, RGB10p32	555560	1909.8	30243
Binning Horizontal (Max Frame Rate), Exposure Time Minimum			
Mono8	103093	1909.4	34641
Mono10, Mono12	133334	1909.4	-82
Mono10Packed, Mono12Packed	103093	1909.4	2140
Binning Vertical (Max Frame Rate), Exposure Time Minimum			
Mono8	133334	1909.8	-446
Mono10, Mono12	270272	1909.8	6215
Mono10Packed, Mono12Packed	200000	1909.8	1062
Binning Horizontal & Binning Vertical (Max Frame Rate), Exposure Time Minimum			
Mono8	103093	1909.4	34663
Mono10, Mono12	133334	1909.4	-60
Mono10Packed, Mono12Packed	103093	1909.4	2162

GOX-20405M-PGE, GOX-20405C-PGE**Exposure Mode = Timed (Frame Start Trigger On, RCT Mode)**

Pixel Format	Frame Period [A] (usec)	Period From Trigger Start Edge to Exposure Start [B] (usec)	Data Invalid Period [C] (usec)
Full (Max Frame Rate), Exposure Time Minimum			
Mono8	166668	1887.8	-418
Mono10, Mono12	333336	1887.8	2380
Mono10Packed, Mono12Packed	250002	1887.8	953
BayerRG8	166668	1887.8	-418
BayerRG10, BayerRG12	333336	1887.8	2380
BayerRG10Packed, BayerRG12Packed	250002	1887.8	953
RGB8	500002	1912.2	4638
RGB10V1Packed, RGB10p32	661368	1912.2	2023
Binning Horizontal (Max Frame Rate), Exposure Time Minimum			
Mono8	103094	1887.8	17893
Mono10, Mono12	166668	1887.8	-439
Mono10Packed, Mono12Packed	126583	1887.8	415
Binning Vertical (Max Frame Rate), Exposure Time Minimum			
Mono8	166668	1887.8	-431
Mono10, Mono12	333336	1887.8	2453
Mono10Packed, Mono12Packed	250002	1887.8	995
Binning Horizontal & Binning Vertical (Max Frame Rate), Exposure Time Minimum			
Mono8	103094	1887.8	17878
Mono10, Mono12	166668	1887.8	-454
Mono10Packed, Mono12Packed	126583	1887.8	401

GOX-24505M-PGE, GOX-24505C-PGE**■ Exposure Mode = Timed (Frame Start Trigger On, RCT Mode)**

Pixel Format	Frame Period [A] (usec)	Period From Trigger Start Edge to Exposure Start [B] (usec)	Data Invalid Period [C] (usec)
Full (Max Frame Rate), Exposure Time Minimum			
Mono8	204082	1909.8	3003
Mono10, Mono12	400001	1909.8	1312
Mono10Packed, Mono12Packed	303032	1909.8	3118
BayerRG8	204082	1909.8	3003
BayerRG10, BayerRG12	400001	1909.8	1312
BayerRG10Packed, BayerRG12Packed	303032	1909.8	3118
RGB8	598454	1909.8	1741
RGB10V1Packed, RGB10p32	796982	1909.8	2591
Binning Horizontal (Max Frame Rate), Exposure Time Minimum			
Mono8	103093	1909.4	1092
Mono10, Mono12	200001	1909.4	-539
Mono10Packed, Mono12Packed	151516	1909.4	245
Binning Vertical (Max Frame Rate), Exposure Time Minimum			
Mono8	204082	1909.8	2985
Mono10, Mono12	400002	1909.8	1355
Mono10Packed, Mono12Packed	303032	1909.8	3160
Binning Horizontal & Binning Vertical (Max Frame Rate), Exposure Time Minimum			
Mono8	103093	1909.4	1076
Mono10, Mono12	200001	1909.4	-497
Mono10Packed, Mono12Packed	151516	1909.4	287

Gain Control

Related Setting Items: [AnalogControl](#)

Adjust the overall gain with AnalogAll (master gain) and adjust the white balance by changing DigitalRed and DigitalBlue.

Color Model

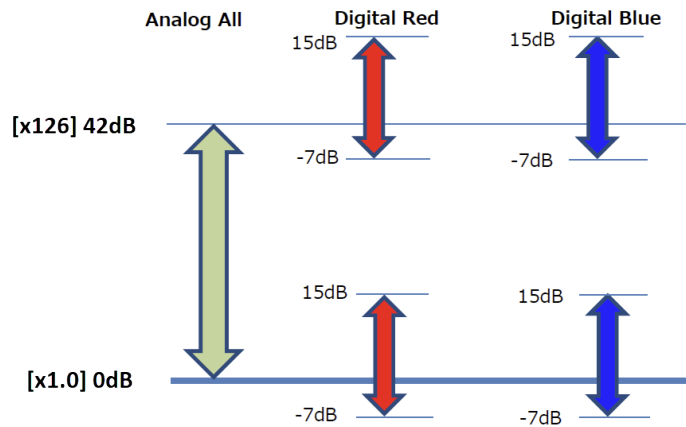

Monochrome Model

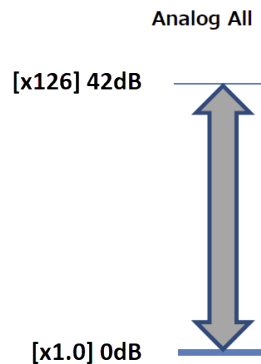

Automatic Gain Level Control

Set GainAuto to **Continuous** to control the gain level automatically.

When GainAuto is set to **Continuous**, you can configure the conditions for automatic adjustment in detail.

- When GainAuto is set to **Continuous**, the automatic adjustment will be performed continuously.
- When GainAuto is set to **Once**, the automatic adjustment will be performed only once.

White Balance

Related Setting Items: [AnalogControl](#)

To adjust the white balance automatically, set BalanceWhiteAuto to **Once** (automatic adjustment only once) or **Continuous** (automatic adjustment always).

The metering area can be limited for automatic adjustment. To limit the metering area, specify each of the 16 areas with AWBAreaSelector and set AWBAreaEnable to True or False.

16 Areas

HighLeft	HighMidLeft	HighMidRight	HighRight
MidHighLeft	MidHighMidLeft	MidHighMidRight	MidHighRight
MidLowLeft	MidLowMidLeft	MidLowMidRight	MidLowRight
LowLeft	LowMidLeft	LowMidRight	LowRight

In addition, the white balance has been adjusted in advance for specific color temperature lighting. It is possible to select from the following four presets. (Color temperature for preset : 3200K, 5000K, 6500K, 7500K)

Color Temperature

The adjustable range of white balance for this camera is 3000K to 9000K.

Please refer to the figure below for an overview of the relationship between various lighting types and color temperature.

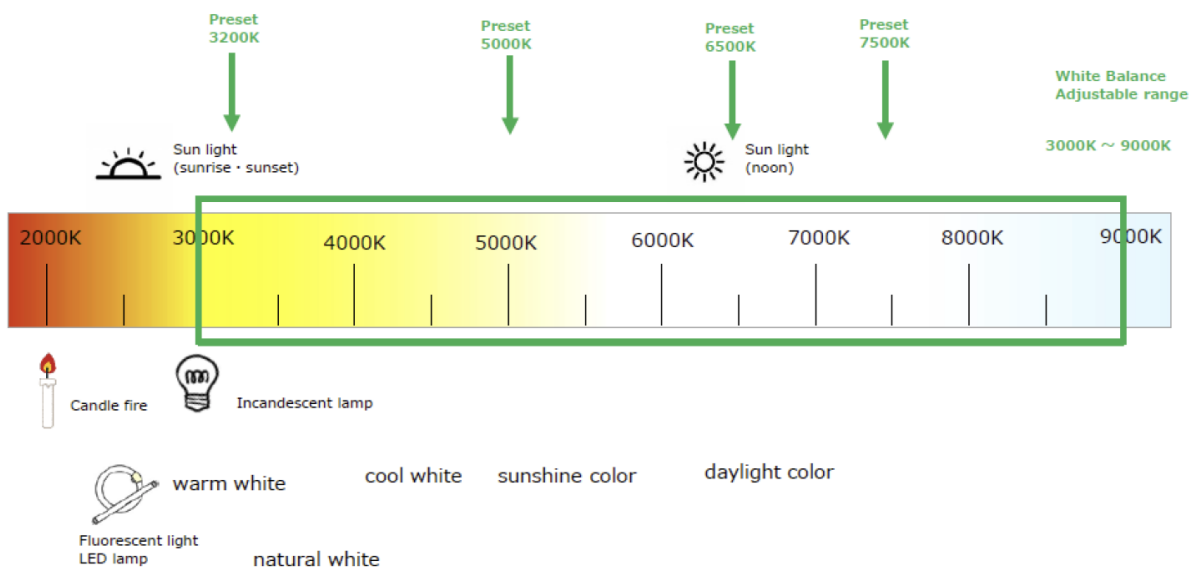

ALC (Automatic Level Control) Function

Related Setting Items: [AutoLevelControl](#)

The ALC (automatic level control) function combines the automatic gain control (AGC/Auto Gain Control) and automatic exposure control (ASC/Auto Shutter Control) functions and is capable of handling various changes in brightness. The function operates as follows in response to changes in brightness.

Change from bright to dark: ASC → AGC

Change from dark to bright: AGC → ASC

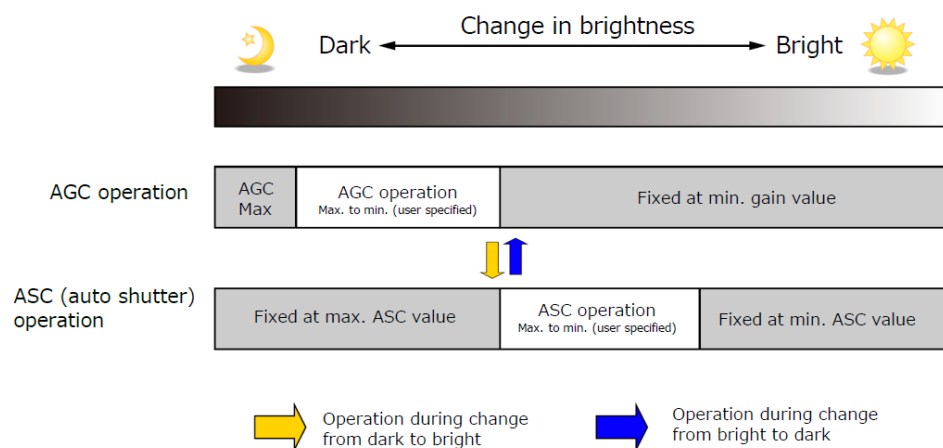

To Use the ALC Function

Set GainAuto or ExposureAuto or both to **Continuous** mode. Configure the minimum value, maximum value, etc. for AGC and ASC in AutoLevelControl.

The target video levels for AGC and ASC are configured in ALCTReference. For example, when ALCTReference is set to 95%, video levels will be maintained at 95% using AGC and ASC.

In color models, the channel to be used as the reference for ALC control can be set.

- **ALCControlReference:** Set whether to specify the SelectedChannel refer to channel (R, G, B) or PeakChannel refer to the channel with the highest average image level.
- If ALCControlReference= SelectedChannel, set ALCControlChannel to **Red**, **Green** or **Blue**.

The speed of ALC control can be set from 1 to 100 (fastest) in ALCControlRatio.

Note: If the ALCControlRatio setting is large, the ALC operation may cause hunting depending on the AcquisitionFrameRate setting. In this case, lower the value of AcquisitionFrameRate or ALCControlRatio.

Gamma Function

Related Setting Items: [AnalogControl](#)

The Gamma function corrects the output signals from the camera beforehand (reverse correction), taking into consideration the light-emitting properties of the monitor display. As the light-emitting properties of the monitor are not linear, the entire image may be darker or the gradation in the dark areas may be less noticeable when camera outputs are displayed without processing.

The Gamma function can be used to correct the camera signals with an opposite-direction curve and produce a display that is close to linear.

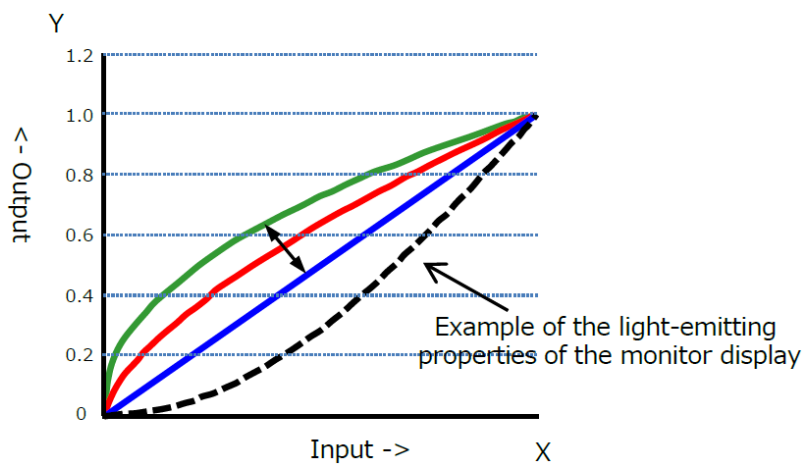

To Use the Gamma Function

Configure the settings as follows.

Item	Setting Value / Selectable Range	Description
Gamma	0.45, 0.5, 0.55, 0.6, 0.65, 0.75, 0.8, 0.9, 1.0	Select the Gamma correction value.
LUTMode	Gamma	Use Gamma.

Note: You can use the LUT function to configure a curve with more detailed points. For details, see [LUT \(Lookup Table\)](#).

LUT (Lookup Table)

Related Setting Items: [LUTControl](#)

The LUT function is used to generate a non-linear mapping between signal values captured on the sensor and those that are output from the camera. You can specify the output curve using 257 setting points (indexes).

To Use the LUT Function

Configure the settings as follows.

Item	Setting Value / Selectable Range	Description
LUTSelector	Red, Green, Blue	Select the LUT channel to control (Color models only).
LUTIndex	0 ~ 256	Select the LUT index to configure. Indexes represent the possible pixel values captured on the sensor, from the lowest value (Index 0) to the highest (Index 256). For example, Index 0 represents a full black pixel and Index 256 represents a full white pixel.
LUTValue	0 ~ 4095	Set the LUT output value for the selected index.

LUT Value

LUT values range from 0 at the lowest to 4095 at the highest. Linear interpolation is used to calculate LUT values between the index points.

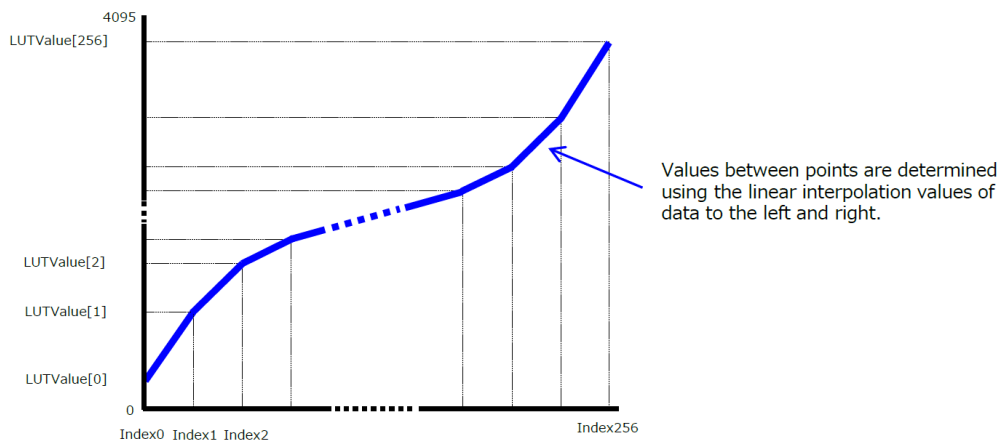

BlemishCompensation

Related Setting Items: [BlemishControl](#)

Multiple defective pixels that are not adjacent to each other can occur on CMOS sensor cameras.

This camera features a function that interpolates defective pixels using the surrounding pixels. Up to 2000 pixels can be corrected. Pixel interpolation can be performed via automatic detection or point-by-point manual settings.

Automatic Detection

Automatic detection can only detect lit defective pixels (i.e., white blemishes).

1. Shield the camera sensor. If a lens is attached, use the lens cap as a shield, for example.
2. Configure the threshold level for defective pixel detection with **BlemishDetectThreshold**.
 - Up to 2000 pixels can be corrected.
 - The threshold value is specified as a percentage.
 - The default setting is "10" with 10% of the full scale (100%) specified as the threshold value.
3. Execute **BlemishDetect** to start automatic detection. After detection, the interpolation data is saved to the camera's internal memory.

To check the number of interpolated pixels after automatic detection

You can check the number of pixels interpolated via automatic detection by loading the BlemishNum data.

Notes:

Automatic detection will not be executed when:

- No image is being output.
- TestPattern is being output
- In Sequencer Mode ([Sequencer Function](#))
- In MultiRoi mode ([ROI Function \(Multi ROI\)](#))
- The image is not full ROI size ([ROI Function \(Single ROI\)](#))
- In Reverse mode ([Image Flip Function](#))
- GradationCompressionMode is not Off ([Gradation Compression Mode](#))
- AcquisitionMode is not Continuous ([Acquisition Control](#))
- Not in lens cap state

Manual Configuration

1. Select the **index** in **BlemishCompensationIndex**. You can select from 1 to 2000. However, configure the indexes in order starting with the smallest index. If you skip indexes while configuring settings, interpolation may not be performed.
2. Specify the pixel points for interpolation using the **BlemishCompensationPositionX** and **BlemishCompensationPositionY** settings.

Notes:

- You can configure values that are within the total effective pixel area. Specify pixels for which interpolation is not necessary as -1. If 0 is specified, the first line or first pixel will be interpolated.
- To delete the configured pixel points, execute **BlemishCompensationDataClear** with the corresponding index selected.

3. Execute **BlemishStore**. Blemish compensation data will be stored.
4. Set **BlemishEnable** to **Enable**, and execute interpolation. If it is set to **Disable all**, all interpolation for defective pixels will be disabled (including the factory-set interpolation data). If set to **Disable user detection**, the factory-set interpolation data remains valid, and only the interpolation data registered in **BlemishCompensationIndex** is disabled.

Shading Correction

Related Setting Items: [ShadingControl](#)

The ShadingCorrection function corrects non-uniformity (i.e., shading) in the amount of light generated by the lens and lighting equipment. Using this function allows correction even if top, bottom, left, and right shading is not symmetrical in relation to the center of the screen (H, V).

This function can be used even when the effective image area is limited (an area with both Width and Height set to more than 512 must be configured) by the [ROI Function \(Single ROI\)](#). In such cases, the correction area is included in the image area configured by the ROI.

Block size is 128 × 128 pixels.

The following shading correction modes are available on the camera.

■ FlatShading (Monochrome model, Color model)

Correction is performed using the area of the screen with the highest brightness level as the reference and adjusting the brightness levels of the other areas to match this level.

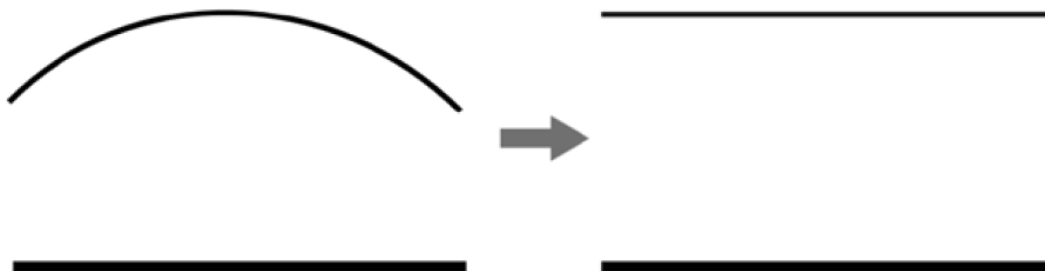

■ ColorShading (Color models only)

R-channel and B-channel properties are adjusted to using the G-channel shading properties as a reference.

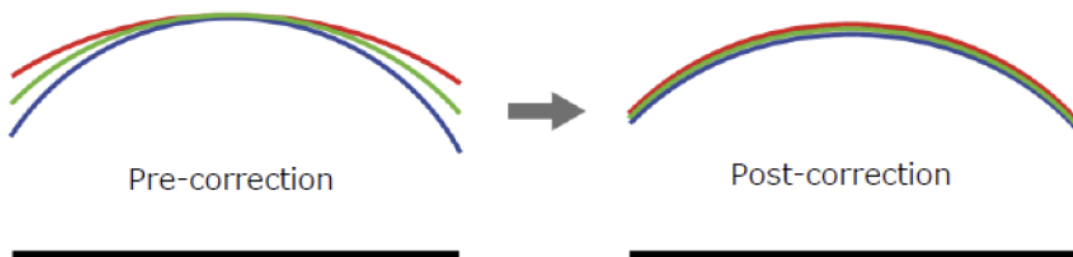

Cautions:

- For FlatShading and ColorShading, the maximum amount of correction gain for all pixels is limited to 8 times the amount of gain before correction. (The amount of gain cannot be increased to more than 8 times the amount of gain from before correction.)
- If the area in the screen with the highest brightness level is 1000 LSB or higher (during 10-bit video output), or if the lowest brightness level is less than 45 LSB (during 10-bit video output), proper correction is not possible.

To Use the Shading Correction Function

Configure the settings as follows.

Item	Setting Value	Description
ShadingCorrectionMode	FlatShading, ColorShading	Select the shading correction mode.
ShadingMode	User1, User2, User3, Off	Select the user area to which to save the shading correction value.

Display a white chart under a uniform light, and execute **PerformShadingCalibration**.

Notes:

- After shading correction is executed, the shading correction value is automatically saved to the user area selected in ShadingMode.
- The PerformShadingCalibration command cannot be executed under the following conditions. (An error also occurs when ShadingMode is set to Off).
 - When outputting no image.
 - When outputting TestPattern.
 - Width and/or Height are less than 512 ([ROI Function \(Single ROI\)](#))
 - In FD2x2Binning mode ([Binning Function](#))
 - In ImageScaling mode ([Image Scaling Mode \(Xscale\)](#))
 - In Decimation mode ([Decimation Mode](#))
 - In Sequencer mode ([Sequencer Function](#))
 - In MultiRoi mode ([ROI Function \(Multi ROI\)](#))
 - In Reverse mode ([Image Flip Function](#))
 - In GradationCompression mode ([Gradation Compression Mode](#))
 - In ALC mode ([ALC \(Automatic Level Control\) Function](#))
 - AcquisitionMode is set to other than Continuous ([AcquisitionControl](#))

Binning Function

Related Setting Items: [ImageFormatControl](#)

The Binning function allows you to combine the signal values of clusters of adjacent pixels to create improved virtual pixels. Using the function results in images with a lower pixel resolution and higher sensitivity in summing mode or reduced noise in averaging mode.

This camera model supports the following binning modes:

- **FD2x2BinningMode** (Floating diffusion binning)
Performs Horizontal x2 and Vertical x2 analog binning (Sum) on the sensor. This option increases the frame rate compared to the BinningHorizontal/BinningVertical options.
- **BinningHorizontal, BinningVertical**
Performs Horizontal x2 and/or Vertical x2 digital binning (Sum or Average) on the FPGA.

Notes:

- Monochrome models only.
- Refer to [Functions That Cannot Be Used Together](#) for usage restrictions.

How to Configure

When configuring **FD2x2BinningMode**, set the setting to **On**. When configuring **BinningHorizontal/ BinningVertical**, set the setting to **2**.

Note: **FD2x2BinningMode** and **BinningHorizontal/ BinningVertical** cannot be used together.



	Binning off	2 x 1	1 x 2	2 x 2
				
FD2x2BinningMode	OFF	N/A	N/A	ON
BinningHorizontal	1	2	1	2
Binning Vertical	1	1	2	2

Image Scaling Mode (Xscale)

Related Setting Items: [ImageFormatControl](#)

JAI's Xscale algorithm digitally reduces the sensor's pixel resolution by specifying the vertical and horizontal scaling ratio. This function can also be used for color models and allows finer adjustment of resolution than the conventional [Binning Function](#).

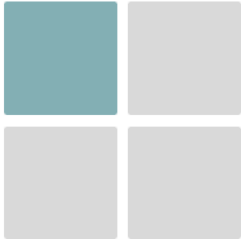
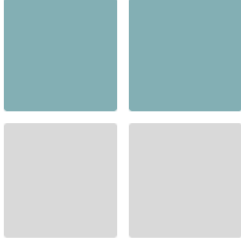
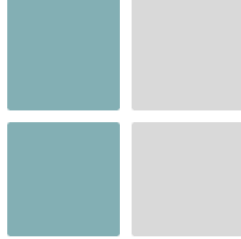
The output image types are Average or Sum.

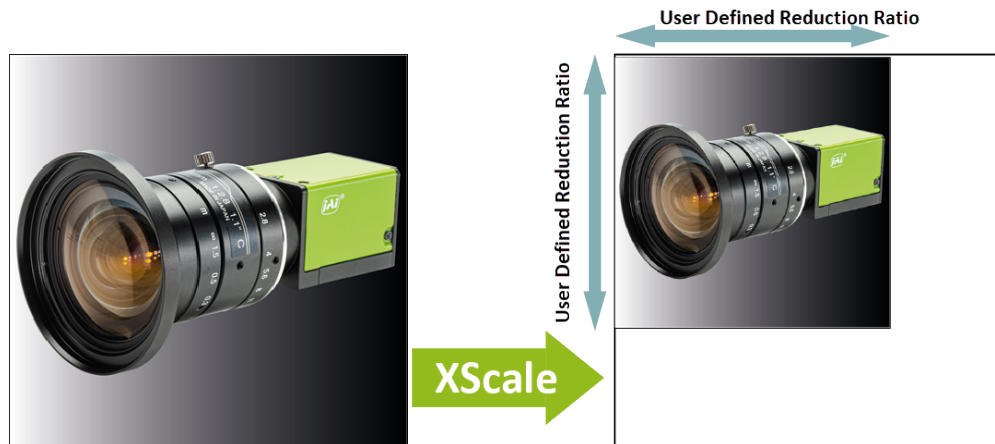

Notes:

- When using this function with the [ROI Function \(Single ROI\)](#), first, set the Width, Height, OffsetX, and OffsetY settings, and then configure the Image Scaling Mode settings.
- Refer to [Functions That Cannot Be Used Together](#) for usage restrictions.

How To Configure

1. If necessary, configure the [ROI Function \(Single ROI\)](#) settings.
2. Set ImageScalingMode (ImageFormatControl) to **On**.
3. Use **ImageScalingSumMode** to specify the output image mode. The options are "**Average** (Off)" or "**Sum** (On)." Depending on the mode, the output image's brightness will be different.

Average Mode: The average brightness of the sensor image is equal to the average brightness of the reduced output image.

Sum Mode: The sum of the brightness of all pixels in the sensor image and the sum of the brightness of all pixels in the reduced output image is equal, thus increasing the brightness of the output image.

4. Use **ImageScalingHorizontal** and **ImageScalingVertical** to specify the horizontal and vertical scaling ratio. For more information on how to specify the scaling ratio, see [Specifying the Scaling Ratio](#).

Specifying the Scaling Ratio

Specify the scaling ratio in decimal point (maximum six decimal places) for **ImageScalingHorizontal** and **ImageScalingVertical**. The setting range is 0.0625 to 1. If "1" is specified, the image will not be scaled.

Cautions:

- Xscale automatically rounds down the width to the nearest value that is a multiple of 4 and rounds down the height to the nearest value that is a multiple of 2.

Before rounding down, width and height calculations are first rounded (up or down) to seven significant digits. If the subsequent rounding down to the nearest multiple of 4 (or 2) results in a value that is beyond Xscale's maximum 16X scaling limit, the value is rounded up to the nearest multiple of 4 (or 2) and the corresponding **ImageScalingHorizontal/Vertical** value is adjusted accordingly.

- eBUS Player may automatically round the value and display a different value.

Note: When using Xscale, the horizontal and vertical scaling factors determine the size of the virtual pixels in the scaled image. This information, plus any ROI that has been preset by the user, determines the maximum number of whole virtual pixels possible in the output image.

Example 1

If you want to output an image with 50% scaling both horizontally and vertically, set **ImageScalingHorizontal** and **ImageScalingVertical** to "0.5". (This is equivalent to the traditional 2 x 2 binning.)



Example 2

When you are replacing your camera with a new one, but the new camera has a different pixel size and resolution, you can reproduce the current camera's pixel size and output image size on the replacement camera, using the [ROI Function \(Single ROI\)](#) and `ImageScalingMode` functions.

This example shows how to configure the ROI and `ImageScalingMode` settings when replacing the GOX-2402C camera with the GOX-5105C camera.

	Pixel Size	Full Resolution (Width x Height)
Current Camera: GOX-2402C	3.45 μm x 3.45 μm	1920 x 1200
New Camera: GOX-5105C	2.74 μm x 2.74 μm	6.8 mm x 5.7 mm (8.82mm diagonal)

1. First, find the scaling ratio for the ROI. To make the virtual pixel size of the new camera (GOX-5105C) the same size as the current camera (GOX-2402C), the scaling ratio is "0.79" ($2.74 \div 3.45 = 0.79$).
2. Next, configure the ROI settings for the new camera (GOX-5105C). Set the new camera's **Width** and **Height** (`ImageFormatControl`) as follows:
 - a. Width: $1920 \div 0.79 = 2430$. However, since the ROI Width Step is 4, set Width to "2432".
 - b. Height: $1200 \div 0.79 = 1519$. However, since the ROI Height Step is 2, set Height to "1520".

Note: If the specified ROI is larger than the supported resolution of the replacement camera, you will need to switch to a replacement camera with a higher resolution.

3. Turn the new camera's **ImageScalingMode On**.
4. Set **ImageScalingHorizontal** and **ImageScalingVertical** to "0.789474" ($1920 \div 2432 = 0.789474$ and $1200 \div 1520 = 0.789474$).

Note: `ImageScalingHorizontal` and `ImageScalingVertical` can be set up to 6 decimal places, but eBUS Player may automatically round the value and display a different value.

5. Now the new camera's virtual pixel size is 3.45 μm x 3.45 μm , and the output image size is 1920 x 1200.

Example 3

If you are using a GOX-20405 camera with SensorWidth/SensorHeight of 4512, and you want to scale the output image to 3000 x 3000, set ImageScalingHorizontal and ImageScalingVertical to "0.6649" ($3000 \div 4512 = 0.6649$).

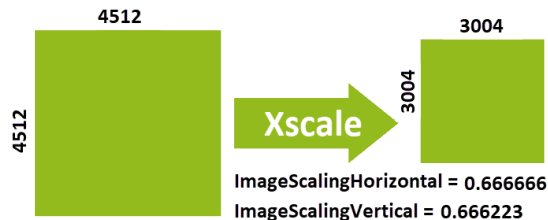

Decimation Mode

Related Setting Items: [ImageFormatControl](#)

Decimation mode performs 2X downsampling of the image in both the horizontal and vertical direction. This reduces the file size for processing or storage while maintaining the full field of view of the image.

Notes:

- Refer to [Functions That Cannot Be Used Together](#) for usage restrictions.
- DecimationHorizontal and DecimationVertical cannot be set separately. For example, changing DecimationHorizontal to 2 will automatically change DecimationVertical to 2.

Image Compression Mode (Xpress)

Related Setting Items: [ImageFormatControl](#)

JAI's own Lossless compression algorithm reduces and fully restores image data without loss of data. As a result, the output frame rate can be increased.

Note: Image Compression Mode cannot be used with [Burst Trigger Mode](#) or [ROI Centered](#).

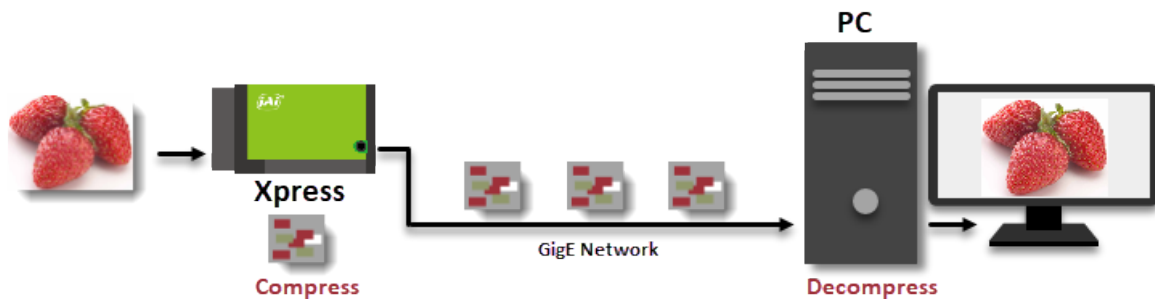

How to Display Compressed Image

When image data is compressed by Image Compression Mode, the output format is no longer in [Pixel Format's](#) format (Mono8 or Bayer8). Therefore, the standard tools such as eBUS SDK for JAI will not display the compressed image correctly.

To decode compressed image data and display it in the original pixel format, use one of the following methods.

■ Use Beta Application (eBUS Player for Xpress)

Restore compressed image by eBUS Player for Xpress, beta application. For more information, see [How to Configure](#). eBUS Player for Xpress is available at the JAI software site (<https://www.jai.com/support-software/jai-software>).

■ Use Decompression Library

Restore compressed image by the Decompression Library on the software you use. To use this method, you must have coding knowledge. For more information, see [How to Use Decompression Library](#). Decompression Library is available at <https://github.com/jai-public>.

How to Configure

This section describes how to use the beta application (eBUS Player for Xpress) to display compressed image streams.

Cautions:

- eBUS Player for Xpress is currently a beta version and only recommended to use for testing the network load and/or the CPU load when ImageCompressionMode is set to **Lossless**.
- When in Image Compression mode, the AcquisitionFrameRate setting range is expanded to the assumed frame rate value at the maximum compression ratio regardless of the actual compression ratio of the output image. Please determine the frame rate value by following steps described in the [Configure the Acquisition Frame Rate](#) topic.

Download eBUS Player for Xpress

1. Verify that you have installed eBUS SDK for JAI version **6.2.4** or **6.2.15** on your PC.

Notes:

- You can find the version information of eBUS SDK for JAI in the About eBUS Player for JAI dialog (**Help > About eBUS Player for JAI**).

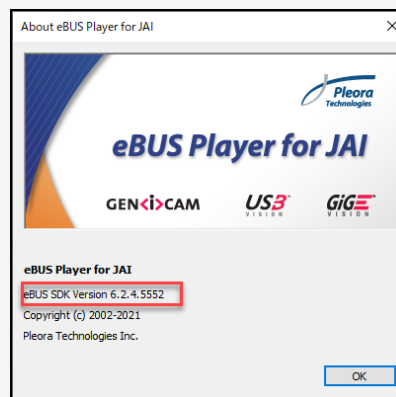

- If the specified version is not installed on your PC, download eBUS SDK for JAI version 6.24 or 6.2.15 to your PC. For more information, see [Step 1: Install the Software \(First Time Only\)](#).

2. Download **eBUS Player for Xpress** that matches the version of eBUS SDK for JAI installed on your PC from the JAI software page (<https://www.jai.com/support-software/jai-software>).

Caution: If the version does not match, eBUS Player for Xpress will not work.

3. Double-click to open **eBUS Player for Xpress** and start configuring settings.

Configure the PixelFormat and Width Settings

- When using a monochrome model, set PixelFormat to **Mono8**. When using a color model, set Pixel Format to **BayerRG8** (if Image Flip Function is used, set to **BayerGR8**, **BayerGB8**, or **BayerBG8**).

Note: If PixelFormat is set to a different format, ImageCompressionMode is fixed to **Off**.

- If using ROI Function (Single ROI) and/or Image Scaling Mode (Xscale) together with Image Compression mode, there are restrictions on the Width value setting.
 - When the Width value is less than 128, ImageCompressionMode is fixed to **Off**.
 - When ImageCompressionMode is set to **Lossless**, the ROI Width step will be 128. If the Width value before configuring ImageCompressionMode is not multiple of 128, the value will be automatically converted. If ImageCompressionMode is switched to **Off**, the Width value will remain a multiple of 128.
 - When Image Scaling Mode (Xscale) and Image Compression Mode are used together, the Width value may be automatically changed because of the limitations of both functions. First, the Width value may be changed to a multiple of 4 due to the ImageScalingMode limitation, and then the Width value may be changed to a multiple of 128 due to the ImageCompressionMode limitation.

The table below shows the Width values of each camera model when ImageScalingHorizontal is set to 0.5 (Full ROI).

Camera Model	Default Width (Full ROI)	ImageScalingHorizontal = 0.5 (Step: 4)	ImageCompression Mode = Lossless (Step 128)
GOX-5105MC-PGE	2472	1236	1152
GOX-8105MC-PGE	2856	1428	1408
GOX-12405MC-PGE	4128	2064	2048
GOX-16205MC-PGE	5328	2664	2560
GOX-20405MC-PGE	4512	2256	2176
GOX-24505MC-PGE	5328	2664	2560

Configure the Acquisition Frame Rate

When in Image Compression mode, the AcquisitionFrameRate setting range is expanded to the assumed frame rate value at the maximum compression ratio, regardless of the actual compression ratio of the output image. Please determine the frame rate and trigger interval by following below steps.

1. While setting **ImageCompressionMode** to **Off** (Default = Off), set **AcquisitionFrameRate** ([AcquisitionControl](#)) to the maximum value.

Note: AcquisitionFrameRate's maximum value depends on the camera settings (for more information, see [Changing the Frame Rate](#)). The maximum value for the current settings is displayed in eBUS Player's Device Control dialog.

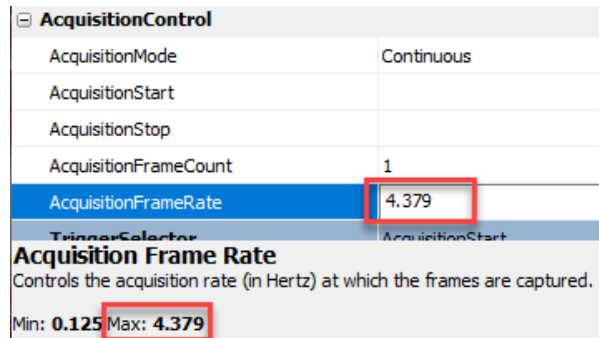

2. Set **ImageCompressionMode** ([ImageFormatControl](#)) to **Lossless**.

Note: At this point, the Acquisition Frame Rate value remains the same as before setting ImageCompressionMode to **Lossless**.

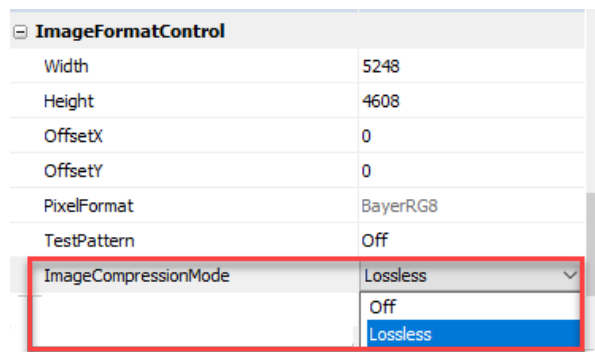

3. If you use Trigger Mode, select **FrameStart** from **TriggerSelector**, and set **TriggerMode** to **On**.

Note: When in Image Compression mode, AcquisitionFrameRate functions as a parameter that pre-configures the trigger interval (normally, AcquisitionFrameRate is disabled when Trigger Mode is ON).

4. Start acquiring images. The compressed image starts to stream and eBUS Player will display the restored images.
5. Determine the **AcquisitionFrameRate** value. When AcquisitionFrameRate is appropriately set, eBUS Player's Display section will display approximately **850Mbps** without Errors.
 - **TriggerMode = Off:** Gradually increase the AcquisitionFrameRate value, and determine the appropriate frame rate value.
 - **TriggerMode = On:** Gradually increase the AcquisitionFrameRate value as well as the trigger signal period, and determine the appropriate frame rate value.

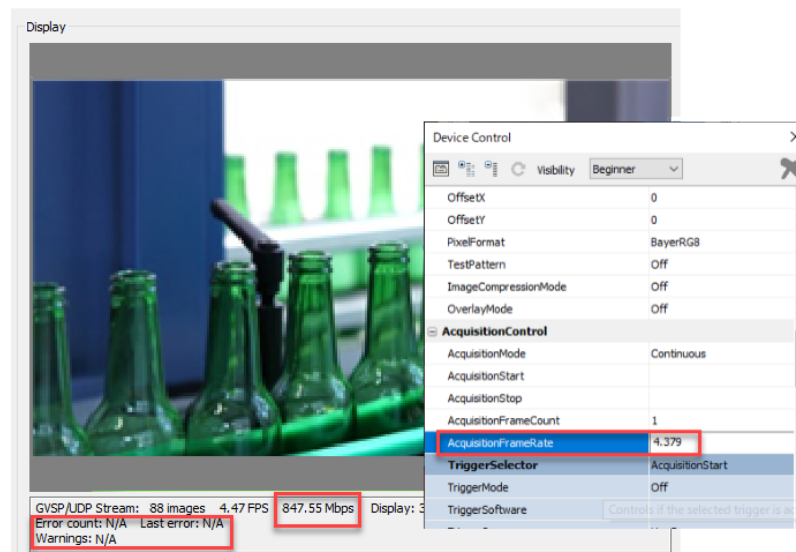

Notes:

- When **TriggerMode** is set to **On**, if a trigger signal is an input with a period shorter than the AcquisitionFrameRate value, the trigger signal will be masked and the output image will be thinned out (the frame rate cannot be faster than the AcquisitionFrameRate value).
- When **TriggerMode** is set to **On**, if the AcquisitionFrameRate value is too large, images may not be output even with the long trigger period.

6. If the compression ratio is low and the I/F bandwidth is overflowing, the camera stops acquiring images. If this happens, you need to adjust the Acquisition Frame Rate and trigger interval. See [Low Compression Ratio with Overflowing I/F Bandwidth](#) for more information.

Low Compression Ratio with Overflowing I/F Bandwidth

If the compression ratio is low and the I/F bandwidth is overflowing, eBUS Player stops displaying images. In this case, make the following adjustments.

- **FrameStartTrigger = Off:** To restore all compressed images, adjust Acquisition Frame Rate to match the fame rate displayed on eBUS Player.
- **FrameStartTrigger = On:** To restore all compressed images, adjust Acquisition Frame Rate and Trigger Interval so that the images are displayed on eBUS Player and the frame rate on eBUS Player matches the adjusted value.

■ Compression Ratio

The compression ratio can be checked by referring to the **data rate (Mbps)** in the Display section of the eBUS Player.

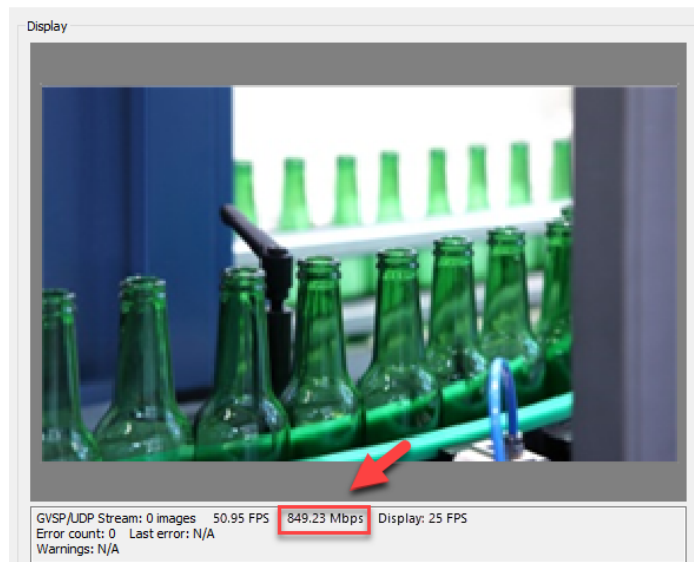

When ImageCompressionMode is set to Off and NetworkThroughputSafetyMargin ([TransportLayerControl](#)) is set to 92 (Default), the data rate at the maximum frame rate setting will be approximately 900 Mbps. When ImageCompressionMode is switched to **Lossless** without changing the AcquisitionFrameRate value, if the image data is not much compressed, the data rate will hardly change from 900 Mbps. If the image data is compressed, the data rate will decrease (the higher the compression ratio, the smaller the data rate value).

How to Use Decompression Library

Below is a brief description of how to use the Decompression Library.

■ CompressedBufferBpp8

This class performs the decompression of 8-bit compressed images on a frame-by-frame basis. (Classes for 10-bit and 12-bit images are not implemented.)

■ Create an Instance

```
/// <summary>
/// Class for decompression of 8-bit compressed images
/// </summary>
/// <param name="src_buffer">Compressed image data</param>
/// <param name="width"></param>
/// <param name="height"></param>
CompressedBufferBpp8(const uint8_t* src_buffer, uint16_t width, const uint16_t
height);
```

Set `src_buffer` to a pointer to a RAW image retrieved from the camera. This library cannot handle uncompressed data. If you input uncompressed data to this library, you may collapse image data. Therefore, please set only compressed image data.

Notes:

- `src_buffer`: Pointer to the buffer that stores frame data received from the camera.
- `width`: Width of image before compression
- `height`: Height of image before compression

Perform a Decompression

```

/// <summary>
/// Perform a decompression
/// </summary>
/// <param name="dest_buffer">decompression address</param>
/// <param name="type">PixelFormat</param>
void DoDecompress(uint8_t* dest_buffer, PvPixelFormat type);

```

Decompression is performed by specifying a preallocated buffer and PixelType to expand the decompressed image and then executing DoDecompress. Decompression is executed in a separate thread for each line of the image.

Example: Decompression into PvBuffer

1. Create the destination PvBuffer and allocate memory.

```

PvBuffer buffer;
auto image = buffer.GetImage();
auto result = image->Alloc(width, height, (PixelFormat)type);

```

Note: type: PixelType of the image before compression

2. Decompresses image->GetDataPointer().

```

// in_buffer= compressed data pointer
auto compressed = jaids::lossless::CompressedBufferBpp8((uint8_t*)in_buffer,
width, height);
compressed.DoDecompress(image->GetDataPointer(), (PixelFormat)type);

```

Gradation Compression Mode

Related Setting Items: [ImageFormatControl](#)

This function compresses the bit depth of captured images to enable images containing a wide range of pixel values to be output as a narrower set of intensity gradations.

Notes:

- This function cannot be used when [SensorDigitizationBits](#) is set to 8Bits.
- When GradationCompressionMode is turned On, the [Pixel Format](#) is forced to be controlled as follows:
 - Mono models: Mono8
 - Bayer format (color models): BayerRG8 (When ReverseX/Y is On, the flipped Bayer format is used).
 - RGB format (color models): RGB8

In Gradation Compression Mode, the sensor first converts the analog signal into 10bits or 12bits digital signal (= A/D conversion), and then the A/D-converted signal exceeding the compression knee point (s) is compressed and the entire image is output as 8bits data. (Whether A/D conversion is performed at 10 or 12 bits is based on the [SensorDigitizationBits](#) setting.)

The apparent sensitivity of the uncompressed area below the knee point is x4 at 10bits and x16 at 12bits.

The maximum value of each dynamic range is 400% at 10bits and 1600% at 12bits, comparing to the 8bits output.

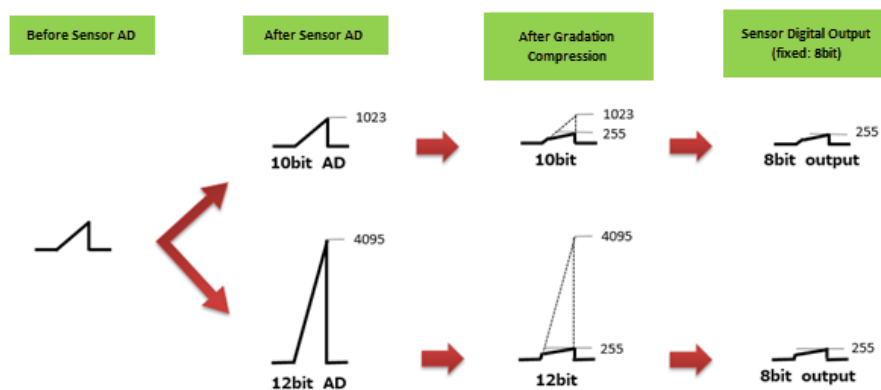

How to Configure

1. Set **GradationCompressionMode** to **On** to enable the function.
2. Select a value for **GradationCompression1stKneePoint** to indicate where to start applying compression on the intensity values coming from the sensor. The knee point is specified as a percentage of the maximum digital value of the 8-bit compressed output (255).
3. Select a value for **GradationCompression1stGain** in order to set the slope angle at the first knee point. Available values range from 0 dB (no compression) to -66 dB.
4. Use **GradationCompression2ndKneePoint** and **GradationCompression2ndGain** to define an additional compression segment.

Note: 2ndKneePoint must be specified with a value greater than 1stKneePoint. The maximum value is 200% when SensorDigitizationBits is set to 10Bits, and 800% when SensorDigitizationBits is set to 12Bits.

Examples

The following examples show how Gradation Compression knee points and gain can be calculated and applied.

SensorDigitizationBits = 10Bits

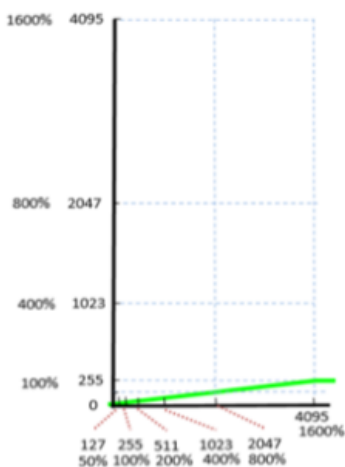

GradationCompressionMode = Off

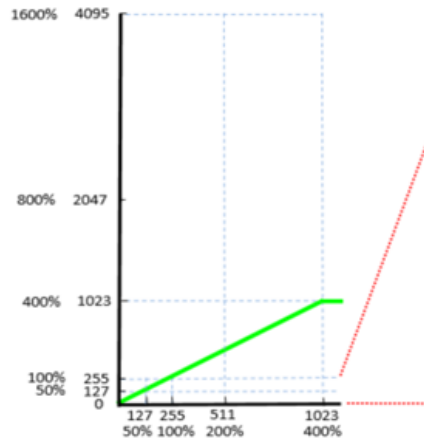

GradationCompressionMode = On
GradationCompression1stGain = 0dB
GradationCompression2ndGain = 0dB

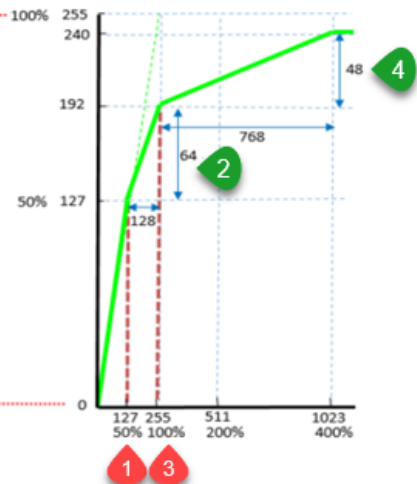

GradationCompressionMode = On
 1 GradationCompression1stKneePoint = 50%
 2 GradationCompression1stGain = - 6dB
 ($64/128 = 1/2 = -6dB$)
 3 GradationCompression2ndKneePoint = 100%
 4 GradationCompression2ndGain = - 24dB
 ($48/768 = 1/16 = -24dB$)

SensorDigitizationBits = 12Bits

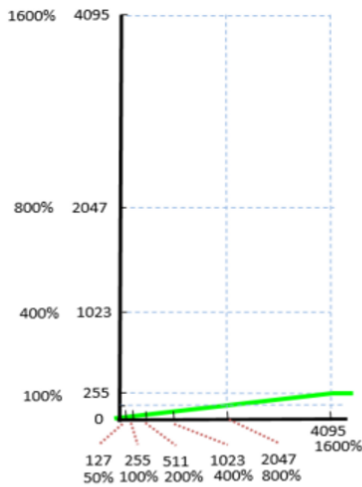

GradationCompressionMode = On

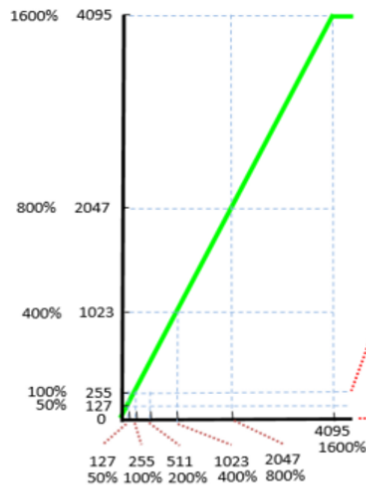

GradationCompressionMode = On
GradationCompression1stGain = 0dB
GradationCompression2ndGain = 0dB

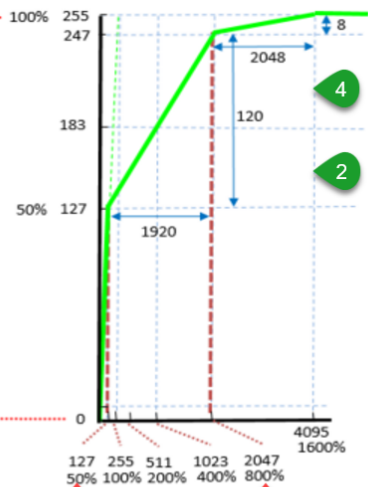

GradationCompressionMode = On
 1 GradationCompression1stKneePoint = 50%
 2 GradationCompression1stGain = -24dB
 (120/190 = 1/16 = -24dB)
 3 GradationCompression2ndKneePoint = 800%
 4 GradationCompression2ndGain = -48dB
 (8/2048 = 1/256 = -48dB)

Cautions:

- When VideoProcessBypassMode is set to **Off**, JAI cannot guarantee the configured knee point value because the GradationCompression1st(2nd)KneePoint value will not match the output signal's knee point level due to the effect of the digital gain value, which is performed during post-processing. In order to avoid this, set VideoProcessBypassMode = **On**.
- When VideoProcessBypassMode is set to **Off**, JAI cannot guarantee the white balance function's performance because the white balance function uses the digital gain during post-processing, and the output signal's knee point level between the RGB channels will not match. In order to avoid this, set VideoProcessBypassMode = **On**, and control the white balance on the Host side.

Overlay Mode

Related Setting Items: [ImageFormatControl](#)

Note: This function cannot be used with the [Sequencer Function](#).

OverlayMode = MultiRoiAreaMode

In this mode, you can check the readout area when using the [ROI Function \(Multi ROI\)](#). The area that is not readout is displayed with the brightness reduced to half. This makes it possible to set and adjust the readout area while checking the target area on the screen.

Notes:

- To set Overlay Mode to **MultiRoiAreaMode**, MultiRoiMode ([MultiROIControl](#)) must be set to **Off** in advance.
- In the following scenario, OverlayMode = MultiRoiMode will be disabled (you can still set to **ALCAreaMode** or **AWBAreaMode**): DecimationVertical/DecimationHorizontal = 2, ImageScalingMode = On, BinningHorizontal = 2, BinningVertical = 2, FD2x2BinningMode = On

OverlayMode = AWBAreaMode or ALCAreaMode

When Overlay Mode is set to **AWBAreaMode** or **ALCAreaMode**, you can check the photometry areas of WhiteBalance and ALC. In the non-target area as shown below, the brightness is reduced to half.

MultiRoiAreaMode



AWBAreaMode or ALCAreaMode

HighLeft	HighMidLeft	HighMidRight	HighRight
MidHighLeft	MidHighMidLeft	MidHighMidRight	MidHighRight
MidLowLeft	MidLowMidLeft	MidLowMidRight	MidLowRight
LowLeft	LowMidLeft	LowMidRight	LowRight

ROI Function (Single ROI)

Related Setting Items: [ImageFormatControl](#)

The ROI (region of interest) function allows you to output images by specifying the areas to scan. Specify the area to scan by specifying width, height, and horizontal/vertical offset values under ImageFormatControl.

The setting ranges for the ROI function's readable area based on the Binning setting (BinningHorizontal, BinningVertical, FD2x2BinningMode) are as follows.

Notes:

- The [Binning Function](#) (Horizontal/Vertical Binning and FD2x2BinningMode) can only be used for monochrome camera models.
- When using this function with [Image Scaling Mode \(Xscale\)](#), first, set the Width, Height, OffsetX, and OffsetY settings, and then configure the Image Scaling Mode settings.
- When [ROICentered](#) is set to **On**, OffsetX will be disabled.
- Refer to [Functions That Cannot Be Used Together](#) for usage restrictions.

Width/OffsetX (Pixels)

Width OffsetX	Binning Mode	Binning OFF	Binning ON	*A,B = WidthMax		
					A	B
Width (pixels)	Horizontal Binning	96 to [(*A) - OffsetX], step 8	48 to [(*B) - OffsetX], step 4	GOX-5105MC-PGE	2472	1236
	FD2x2BinningMode			GOX-8105MC-PGE	2856	1428
Offset X (pixels)	Horizontal Binning	0 to [(*A) - Width], step 8	0 to [(*B) - Width], step 4	GOX-12405MC-PGE	4128	2064
	FD2x2BinningMode			GOX-16205MC-PGE	5328	2664
				GOX-20405MC-PGE	4512	2256
				GOX-24505MC-PGE	5328	2664

Height/OffsetY (Lines)

Height OffsetY	Binning Mode	Binning OFF	Binning ON	*C, D = HeightMax		
					C	D
Height (lines)	Vertical Binning	8 to [(*C) - OffsetY], step 2	4 to [(*D) - OffsetY], step 1	GOX-5105MC-PGE	2064	1032
	FD2x2BinningMode			GOX-8105MC-PGE	2848	1424
OffsetY (lines)	Vertical Binning	0 to [(*C) - Height], step 2	0 to [(*D) - Height], step 1	GOX-12405MC-PGE	3008	1504
	FD2x2BinningMode			GOX-16205MC-PGE	3040	1520
				GOX-20405MC-PGE	4512	2256
				GOX-24505MC-PGE	4608	2304

Single ROI - Example

Binning Off

[BinningHorizontal]: 1, [BinningVertical]: 1

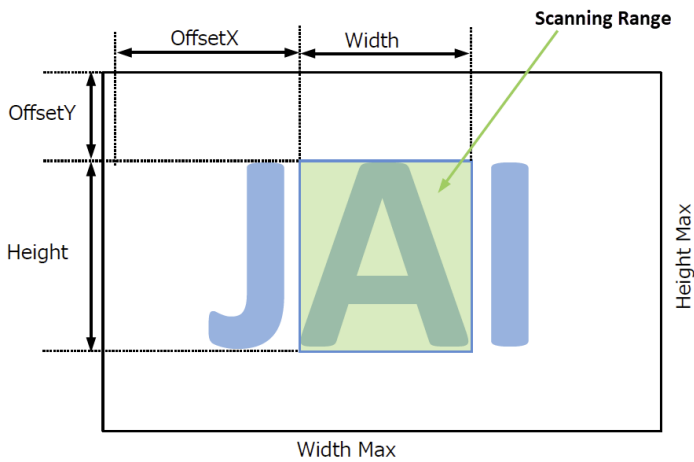

Binning On

[BinningHorizontal]: 2, [BinningVertical]: 2

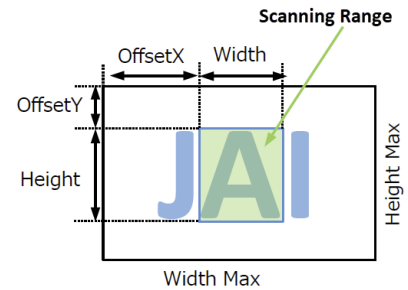

ROI Centered

Related Setting Items: [ImageFormatControl](#)

When **ROI Centered** is set to **ON** while using the [ROI Function \(Single ROI\)](#), OffsetX is disabled and the image output position in the X direction is always forced to be centered.

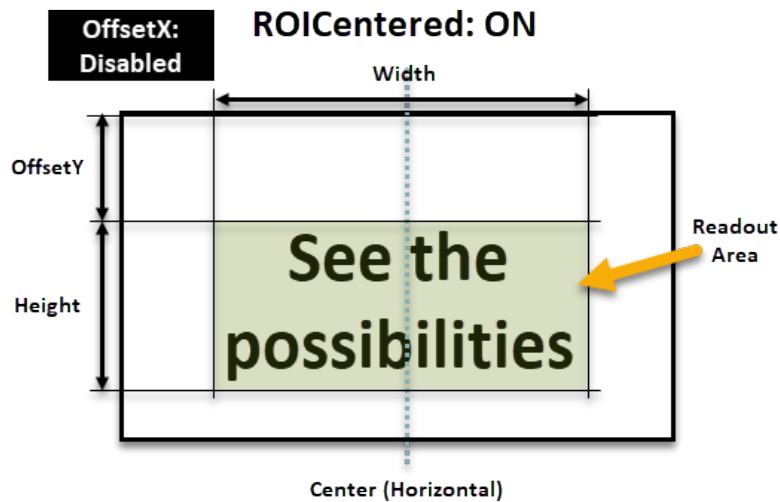

Notes:

- Refer to [Functions That Cannot Be Used Together](#) for usage restrictions.
- When switching this function back to **Off**, the OffsetX value will be 0.

ROI Function (Multi ROI)

Related Setting Items: [MultiROIControl](#)

Notes:

- Refer to [Functions That Cannot Be Used Together](#) for usage restrictions.
- If this function is turned on while [Shading Correction](#) is set to On, Shading Correction will be forced to Off.

In Multi ROI mode, you can specify up to 64 scanning areas for a single-frame image. By skipping areas that are not specified as regions of interest when scanning a frame, the ROI function outputs the specified regions in a combined state. You can increase the frame rate due to the reduced scanning time for the combined areas. However, you cannot increase the frame rate by compressing in the horizontal direction.

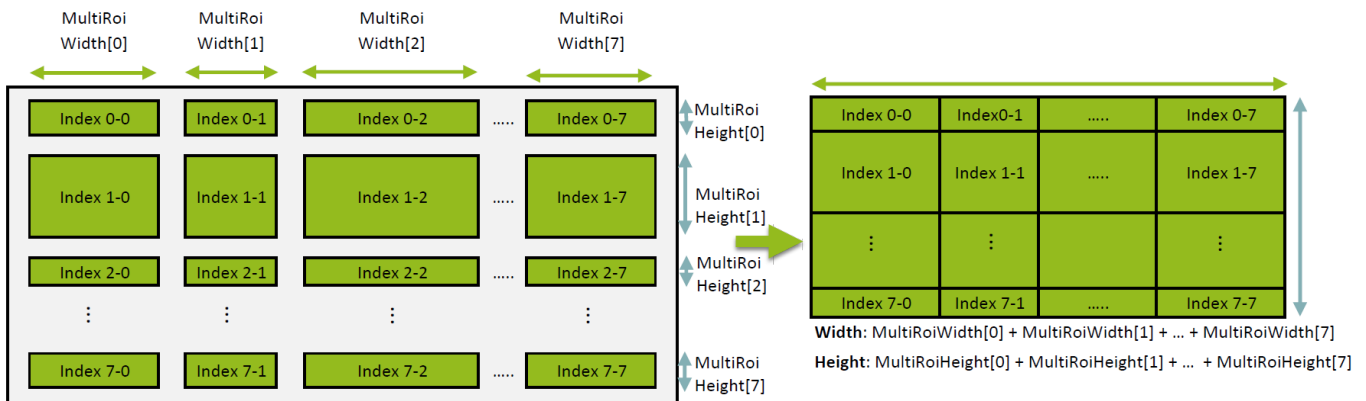

How to Configure

1. Set **MultiRoiMode (MultiROIControl)** to **On**.
2. Select from the eight indexes in **MultiRoiIndex** then set **MultiRoiWidth**, **MultiRoiHeight**, **MultiRoiOffsetX**, and **MultiRoiOffsetY**.
3. Set the maximum index number to be enabled to **MultiRoiVerticalEnableNumber** and **MultiRoiHorizontalEnableNumber**.

Caution: The specified areas cannot overlap. If the areas overlap, all indexes after the overlapping areas become unconfigurable.

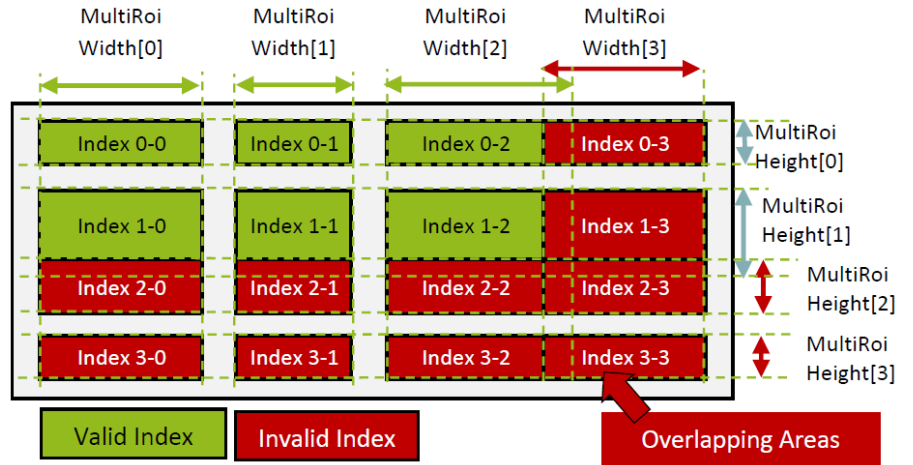

Notes:

- The frame rate can be increased in relation to the size of the area specified in the vertical direction, but not in relation to the horizontal direction.

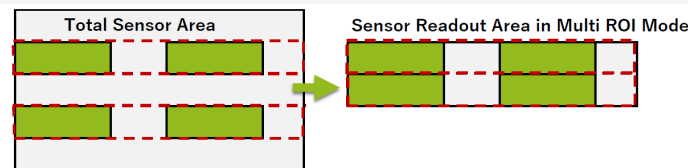

- In the horizontal direction, the configuration for the second and subsequent rows will be identical. In the vertical direction, the configuration for the second and subsequent columns will be identical.

Configuration Example

To use four areas as shown below, refer to the following.

1. Set MultiROIControl->**MultiRoiMode On**.
2. Select "0" in MultiRoiIndex. Set MultiRoiWidth, MultiRoiHeight, MultiRoiOffsetX and MultiRoiOffsetY.
3. Select "1" in MultiRoiIndex. Set MultiRoiWidth, MultiRoiHeight, MultiRoiOffsetX and MultiRoiOffsetY.
4. Set 2 to MultiRoiVerticalEnableNumber.
5. Set 2 to MultiRoiHorizontalEnableNumber.

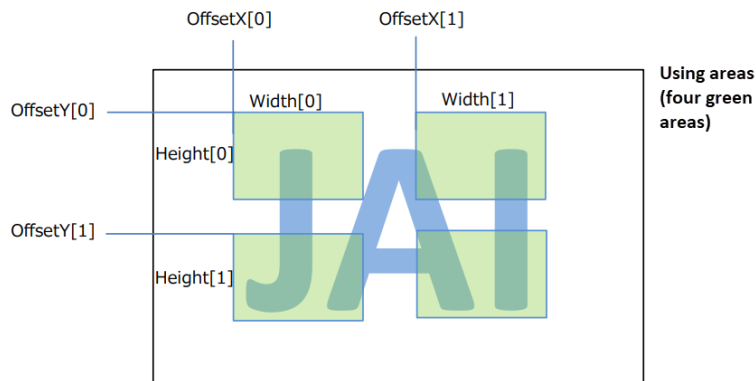

Output image

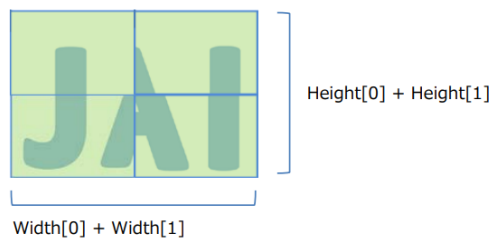

Color Space Conversion (ColorTransformationControl)

Related Setting Items: [ColorTransformationControl](#)

Notes: This function is available only when [Pixel Format](#) is set to **RGB8**, **RGB10V1Packed** or **RGB10p32**.

This camera allows you to convert the standard color space (RGB) that is used to produce colors into other color spaces, including XYZ. Four color spaces are available: RGB(sRGB), RGB(AdobeRGB), RGB(UserCustom), and XYZ. Specify the desired color space by configuring ColorTransformationMode and ColorTransformationRGBMode as follows.

ColorTransformation	ColorTransformationMode	ColorTransformationRGBMode
RGB (sRGB)	RGB	sRGB
RGB (AdobeRGB)	RGB	AdobeRGB
RGB (UserCustom)	RGB	UserCustom
XYZ	XYZ	Off
Default	RGB	Off

Note on RGB (UserCustom)

This allows you to use user-configured 3x3 conversion tables to perform color space conversion.

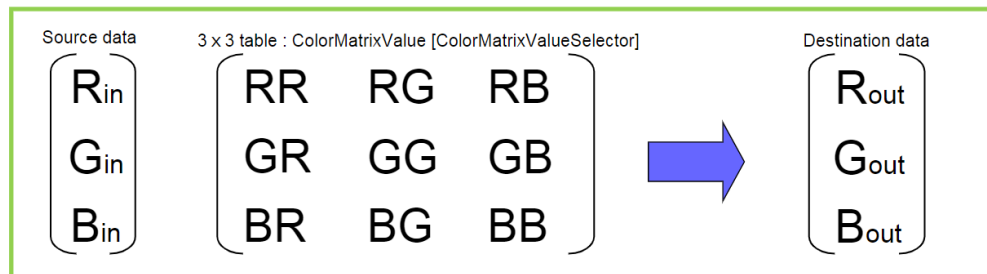

Caution: If you set the color space to XYZ, Control Tool will not display the images captured by the camera properly. To display them properly, XYZ-compatible image processing must be performed on the computer side.

■ Configuration 3x3 table

1. Select the item you want to configure in ColorMatrixValueSelector.
2. Configure the value in ColorMatrixValue.
3. ColorMatrixValue can be set to a value from -2 to +2.

See [ColorTransformationControl](#) for detailed information on the setting items.

Edge Enhancer, Color Enhancer

Related Setting Items: [ImagingControl](#)

This camera is equipped with an Edge Enhancer function for enhancing the contrast of lines or edges within images and a Color Enhancer function for enhancing specified colors.

Edge Enhancer Function

The Edge Enhancer function is enabled when EdgeEnhancerEnable is set to On. Four enhancement levels are available: Low, Middle, High, and Strong.

Note: On this camera, this function is only available for monochrome models.

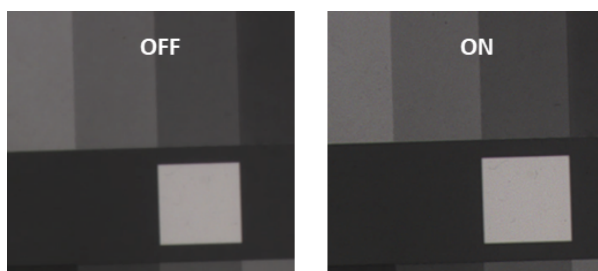

Color Enhancer Function

Notes: This function is available only when [Pixel Format](#) is set to **RGB8**, **RGB10V1Packed** or **RGB10p32**.

The Color Enhancer function is enabled when ColorEnhancerEnable is set to On. Set a value from 0 to 1.0 (0.1 steps) for ColorEnhancerValue to configure the enhancement level: 0 = no enhancement, 1.0 = approx. x2 the color level of the original data.

Six colors can be specified in ColorEnhancerSelector: Red, Cyan, Green, Magenta, Blue, and Yellow.

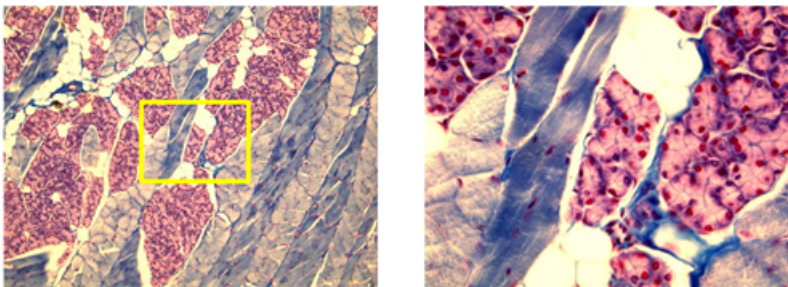

Sequencer Function

Related Setting Items: [SequencerControl](#)

The Sequencer function lets you define up to 32 index combinations of exposure time, gain, ROI, and other settings which can be stepped through each time a trigger is received. This is particularly useful for quickly capturing multiple exposures of objects under inspection to adjust for areas or components with significantly different levels of reflectance. You can specify the next index in the stepping sequence and the order in which indexes are executed. Multiple indexes can also be executed repeatedly.

Two operation modes (TriggerSequencer mode and CommandSequencer mode) are available for the Sequencer function.

Notes:

- Refer to [Functions That Cannot Be Used Together](#) for usage restrictions.
- Up to 32 indexes can be configured. For details on the items that can be set for each index, see [SequencerControl](#).

Cautions:

- If the values of [ImageFormatControl](#)'s Width and Height are smaller than SequencerControl's SequencerWidth and SequencerHeight, the image may not be output correctly.
- When using SequencerWidth / SequencerHeight, set the Width and Height to the default values in advance.

TriggerSequencer Mode

With this mode, the Sequencer Trigger “pattern” is predetermined by the user. The user defines up to 32 different “indexes.” Different camera settings can be configured for each index. The operation of this mode is controlled using the following five commands.

Caution: In TriggerSequencer mode, the TriggerOverlap function of the FrameStart trigger is disabled and the operation is always Off.

SequencerSetActive: This allows you to confirm the index number displayed on the next trigger reception.

SequencerSetStart: This configures the index number to execute at the start of TriggerSequencer mode.

SequencerFrameCount: This configures the number of frame acquisitions for the selected SequencerIndex.

SequencerReset: During TriggerSequencer mode operation, this switches the index number to be executed to that specified in SequencerSetStart.

SequencerRepetition: This parameter applies to TriggerSequencer patterns which include an index whose SequencerROINextIndex is set to 0 (OFF).

When the index whose SequencerROINextIndex is set to 0 (OFF) is finished executing, the value of Sequencer Repetition (range = 1 ~ 255) is decremented internally. If the result of the decrement is not zero, the TriggerSequencer pattern starts over from the index specified in SequencerSetStart. If the result of the decrement is zero, the status changes to Acquisition Stop and external triggers are not accepted.

Sample TriggerSequencer Mode Operation

User-Defined Indexes (Up to 32)

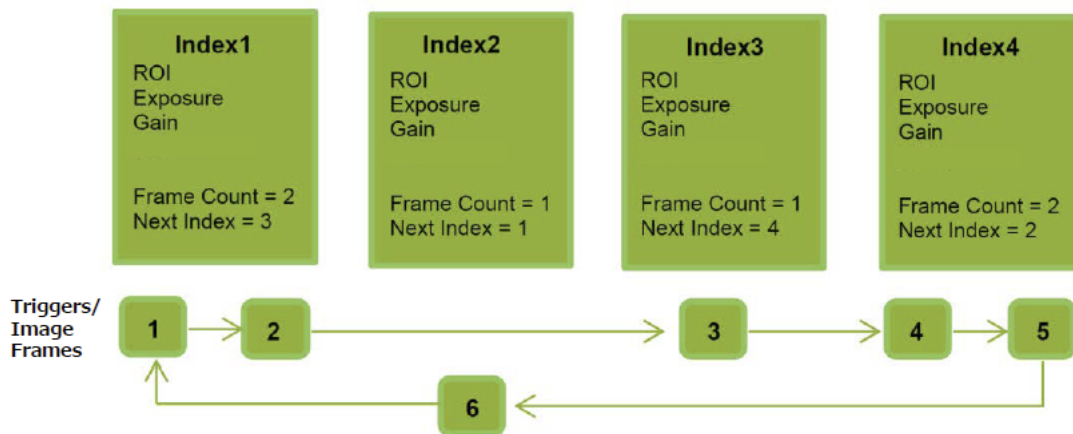

1. Specify "1" in SequencerSetStart and start TriggerSequencer mode with index 1.
2. Based on the SequencerFrameCount setting (= 2), capture a 2-frame image with the first and second triggers.
3. For the next index, configure index 3 specified in SequencerSetNext, and capture an image with the number of frames (the number of triggers) specified in SequencerFrameCount (=1).
4. Proceed to sequence from index 4 to index 2 to index 1.

Note: In addition to repeating multiple conditions as in the above example, you can specify "0" (which indicates the end of TriggerSequencer mode) in SequencerSetNext of index 2 and specify the number of repetitions in SequencerRepetition.

CommandSequencer Mode

As with TriggerSequencer mode, you can define up to 32 indexes beforehand in this mode. Set SequencerCommandIndex to point to one of your preconfigured indexes. This index will be executed on each trigger, until it is changed to point to a different index, typically by your vision application.

In this way, Command Sequencer mode allows you to programmatically adjust your sequence in response to image analysis or input from other sensors.

Notes:

- The same index table will be executed for subsequent triggers unless the CommandSequencerIndex value is changed.
- SequencerFrameCount, SequencerSetNext and SequencerRepetition cannot be used in CommandSequencer mode.

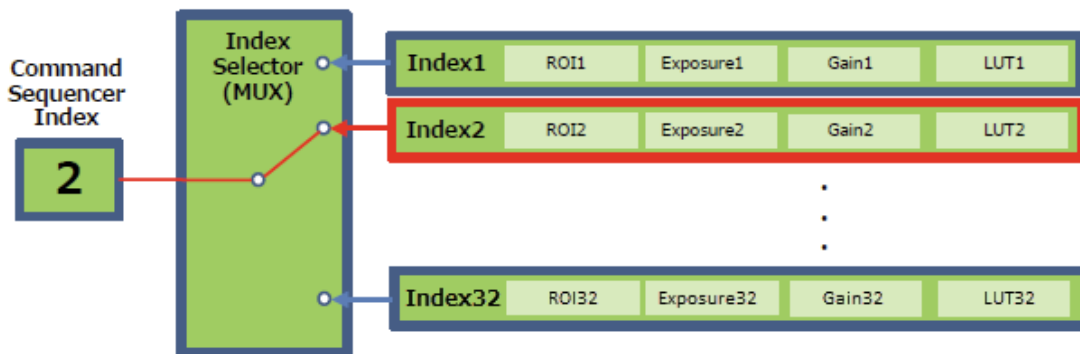

Pulse Generator

Related Setting Items: [PulseGenerator](#)

Technical Notes Tips for using the Pulse Generator

By using this function, any signal can be generated inside the camera.

The following is an example of signal generation.

Settings

- PulseGeneratorStartPoint = 2
- PulseGeneratorEndPoint = 6
- PulseGeneratorLength = 10
- PulseGeneratorPulseWidth = 4
- PulseGeneratorClearSyncMode = AsyncMode

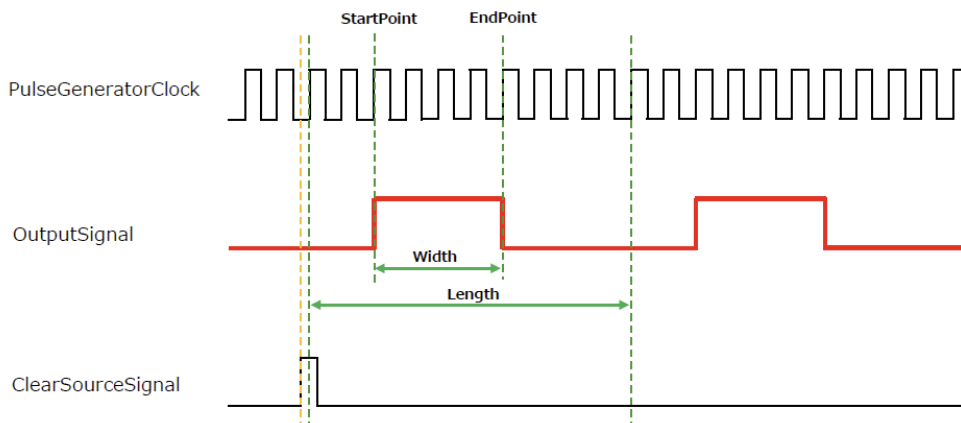

The table below shows the PulseGeneratorClearSource signals that can be set.

	Off	AcquisitionActive	FrameActive	ExposureActive	FVAL	PulseGenerator0	PulseGenerator1	PulseGenerator2	PulseGenerator3	UserOutput0	UserOutput1	UserOutput2	UserOutput3	Line5 Opt In1	NAND0 Out	NAND1 Out	Low	High	AcquisitionTriggerWait	FrameTriggerWait	
PulseGenerator0		✓	✓	✓	✓		✓	✓	✓	✓	✓	✓	✓	✓	✓	✓	✓	✓	✓	✓	✓
PulseGenerator1		✓	✓	✓	✓	✓		✓	✓	✓	✓	✓	✓	✓	✓	✓	✓	✓	✓	✓	✓
PulseGenerator2		✓	✓	✓	✓	✓	✓		✓	✓	✓	✓	✓	✓	✓	✓	✓	✓	✓	✓	✓
PulseGenerator3		✓	✓	✓	✓	✓	✓	✓		✓	✓	✓	✓	✓	✓	✓	✓	✓	✓	✓	✓

Counter and Timer Control Function

Related Setting Items: [CounterAndTimerControl](#)

Note: This camera supports only the counter function.

The counter function counts up change points in the camera's internal signals using the camera's internal counter and reads that information from the host side. This function is useful for verifying error conditions via the count value using internal camera operations.

Four counters are available on the camera; Counter0, Counter1, Counter2, and Counter3. The functions that can be counted are fixed for each counter.

- Counter0: Counts the number of FrameTrigger.
- Counter1: Counts the number of ExposureStart.
- Counter2: Counts the number of SensorReadOut.
- Counter3: Counts the number of FrameTransferEnd.

When a problem occurs in a system that includes this camera, comparing the values from multiple counters allows you to verify the extent of normal operability and can be useful when investigating the cause of the problem.

Counter Occurrence Diagram

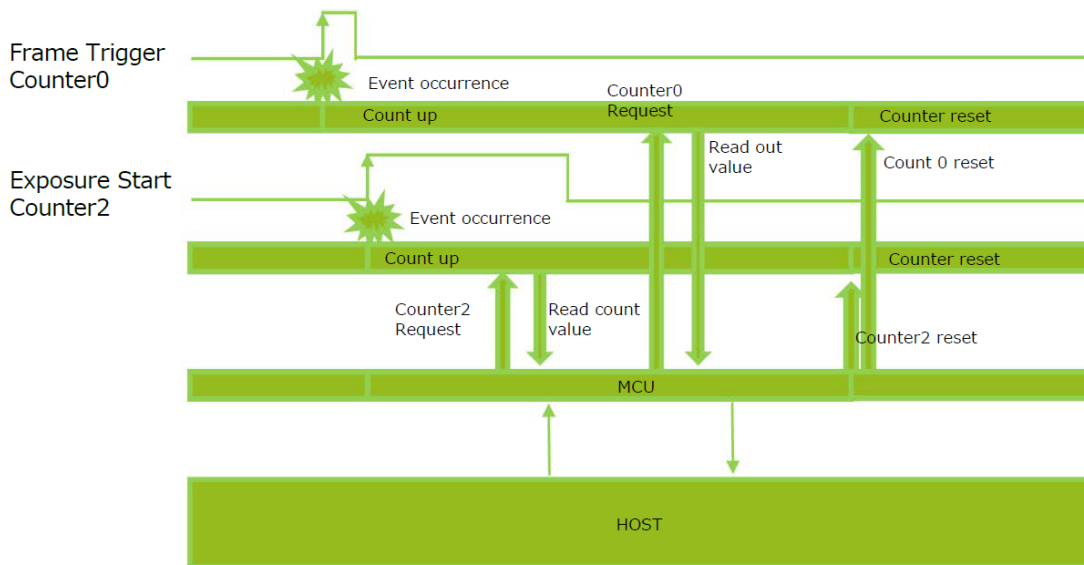

Note: You can reset a specific counter's count value by executing CounterReset[Counter0, Counter1, Counter2, Counter3].

Internal Camera Blocks

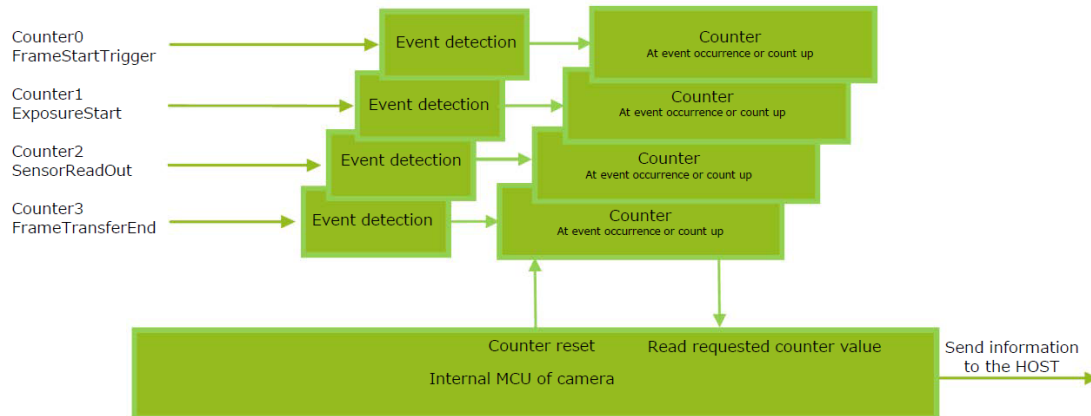

To Use the Counter Function

Configure the settings as follows.

Four counters are available. Specify a counter (Counter0 to Counter3), and configure the settings.

Item	Setting Value Selectable Range	Description
Counter 0 ~ 3	Counter 0 ~ 3	Select the counter.
CounterEventSource	Counter0: Off, Frame Trigger Counter1: Off, ExposureStart Counter2: Off, SensorReadOut Counter3: Off, FrameTransferEnd	Select the Counter Event signal for which to read the count value. When set to Off, the counter operation will stop (but will not be reset).
CounterEventActivation	When the Counter function is enabled: Counter0, Counter1, Counter2 = RisingEdge (Fixed) Counter3 = FallingEdge (Fixed)	Specify timing at which to count.

Action Control Function

Related Setting Items: [ActionControl](#)



Technical Notes

How to use GigE Vision Action Commands

The Action Control Function is a function that executes the pre-configured action when the camera receives action commands. Action commands can send both unicast and broadcast messages and give instructions for actions to multiple cameras simultaneously by broadcasting them. A camera that has this function can even give instructions for actions to different types of multiple cameras. Although this function includes jitter and delays, it is useful for controlling multiple cameras simultaneously.

When the [PTP \(Precision Time Protocol\)](#) function is turned on, Scheduled Action Command (Action Control function) becomes available, which allows you to send Action Commands to multiple cameras synchronized with PTP at the same time.

Actions are performed when the following three conditions are met.

1. ActionDeviceKey set to the camera and ActionDeviceKey in the action command match.
2. ActionGroupKey set to the camera and ActionGroupKey in the action command match.
3. ActionGroupMask set to the camera and GroupMask in the action command perform AND operation, and the result is not 0.

How to Configure

1. Specify ActionDeviceKey.
2. Then, specify two actions that can be configured on the camera.
 - a. Action1
 1. Select 1 in ActionSelector.
 2. Specify ActionGroupMask [ActionSelector].
 3. Specify ActionGroupKey [ActionSelector].
 - b. Action2
 1. Select 2 in ActionSelector.
 2. Specify ActionGroupMask [ActionSelector].
 3. Specify ActionGroupKey [ActionSelector].
3. Set triggers (AcquisitionStart, AcquisitionEnd, FrameStart, AcquisitionTransferStart) to Action1 and Action2.

Action Control Example

Assume that the following settings have been pre-configured on the camera.

- ActionDeviceKey : 0x00001001
- ActionGroupMask[1] : 0x00000011
- ActionGroupKey[1] : 0x00000001
- ActionGroupMask[2] : 0x00000111
- ActionGroupKey[2] : 0x00000002

When the camera receives action commands (ActionDeviceKey:0x00001001, ActionGroupMask:0x00000011, ActionGroupKey: 0x00000002), Action2 is executed.

When the camera receives action commands (ActionDeviceKey:0x00001001, ActionGroupMask:0x00000011, ActionGroupKey: 0x00000001), ActionDevice and ActionGroupKey [1] match. However, the result of AND operation performed by ActionGroupMask is 0. Therefore, in this case, neither Action1 nor Action2 is executed.

Event Control Function

Related Setting Items: [EventControl](#)

The Event Control function is a function that outputs a signal change point inside the camera as information indicative of an event occurrence (event message).

Flow from Detecting an Event to Sending an Event Message

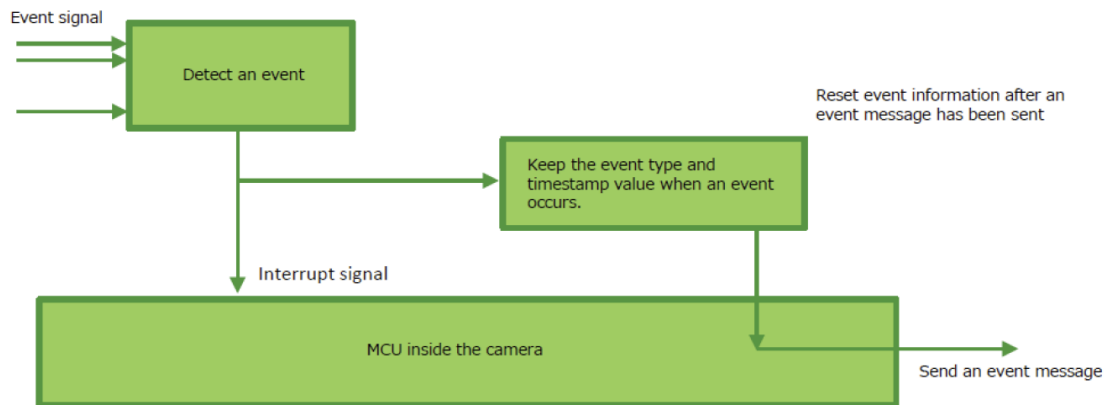

Events That Can Use the Event Control Function

Events that can use the Event Control function are as follows. You can specify whether or not to send an event message when an event occurs at each event.

- AcquisitionTrigger
- FrameStart
- FrameEnd
- ExposureStart
- ExposureEnd

Chunk Data Function

Related Setting Items: [ChunkDataControl](#)

The Chunk Data function adds camera configuration information to the image data that is output from the camera. In addition, when images are shot with a single camera in sequence under multiple setting conditions, you can search for images by their setting conditions.

■ Configuring Chunk Data

1. Set **ChunkModeActive** to **True**.

Caution: The Chunk Data function settings cannot be changed during image output. To change the settings, stop Acquisition.

PTP (Precision Time Protocol)

Related Setting Items: [TransportLayerControl](#)

The camera can work as the slave for Precision Time Protocol defined in IEEE 1588. When the IEEE 1588 master clock exists in the network where the camera is connected, this function synchronizes the camera to the time of the master clock.

- Transport to be used: Multicast UDP datagram (224.0.1.129); however, Delay Resp is a unicast UDP datagram.
- Destination port number:
 - 319 : Sync, Delay Req, Pdelay Req, Pdelay Resp
 - 320 : Announce, Follow Up, Delay Resp, Pdelay Resp, Management, Signaling
- Items for synchronization: Time synchronization is performed. Frequency tuning is not performed.
- PTP time data: 80 bit (elapsed time in 1 ns, with 00:00:00, January 1 1970 set as the origin)
- Timestamp (this camera): 64 bit* (PTP synchronization: LSB64bit* of PTP time data)
- Supported PTP messages: Announce message (receive only), Sync message (receive only), Follow Up message (receive only), Delay Req message (send only), Delay Resp message (receive only)

Cautions:

- The Timestamp Tick Frequency register value is fixed at 1,000,000,000 (1 GHz).
- When PTP synchronization is being performed, the Timestamp Reset function is disabled.
- Because GenICam treats the timestamp (64 bit) as a 64 bit signed integer, 63 bit is actually timestamp data without the sign bit.

How To Configure

1. Set **GevIEEE1588** ([TransportLayerControl](#)) to **True**.
2. After several statuses from Disable, when a Sync Message is received from the PTP server, **Slave** is Displayed in **GevIEEE1588 Status**.

Note: When the PTP function is **On**, you can use Scheduled Action Command ([ActionControl](#)), which allows you to send action commands to multiple cameras synchronized with PTP at the same time.

Functions That Cannot Be Used Together

The table below shows functions that cannot be used with [ImageFormatControl](#), [MultiROIControl](#) and [SequencerControl](#) setting items.

Note: For functions that are not in this table, refer to the relevant function topic or setting item topic.

	Width, Height, OffsetX, OffsetY	ROICentered	FD2x2BinningMode	BinningHorizontal = 2	BinningVertical = 2	ImageScalingMode	DecimationHorizontal/Vertical	ReverseXY	GradationCompressionMode	ImageCompressionMode = Lossless	ALCAreaMode/AWBAreaMode	OverlayMode = MultiRoiAreaMode	MultiRoiMode	SequencerMode
Width, Height, OffsetX, OffsetY (SingleROI)		1				2	⊘							
ROICentered	1		⊘	⊘		⊘	⊘			⊘			⊘	⊘
FD2x2BinningMode		⊘		⊘	⊘	⊘	⊘					⊘	⊘	⊘
BinningHorizontal = 2		⊘	⊘			⊘	⊘					⊘	⊘	
BinningVertical = 2			⊘			⊘	⊘					⊘	⊘	
ImageScalingMode	2	⊘	⊘	⊘	⊘		⊘					⊘	⊘	⊘
DecimationHorizontal/Vertical = 2	⊘	⊘	⊘	⊘	⊘	⊘						⊘	⊘	⊘
ReverseXY														⊘
GradationCompressionMode														⊘
ImageCompressionMode = Lossless		⊘												⊘
OverlayMode = ALCAreaMode/AWBAreaMode														⊘
OverlayMode = MultiRoiAreaMode			⊘	⊘	⊘	⊘	⊘						3	⊘
MultiRoiMode		⊘	⊘	⊘	⊘	⊘	⊘					3		⊘
SequencerMode		⊘	⊘			⊘	⊘	⊘	⊘		⊘	⊘		

Empty	Can be used together
⊘	Cannot be used together
1	When ROICentered is set to On , OffsetX will be disabled.
2	When using Image Scaling Mode (Xscale) together with the ROI Function (Single ROI) , first, set the Width, Height, OffsetX, and OffsetY settings, and then configure the Image Scaling Mode settings.
3	To set Overlay Mode to MultiRoiAreaMode , MultiRoiMode (MultiROIControl) must be set to Off in advance.

Setting List (Feature Properties)

This camera complies with GenICam. Each setting item name conforms to GenICam SFNC (Standard Features Naming Convention). (There are some JAI-specific setting items).

Each setting item is an integer type (Integer), a real type (Float), an element enumeration type (Enumeration), a character string (String), a logical type (Boolean), and a category type (Category) or a command type (Command) for executing the function.

Beginner: For beginner users.

Expert: For users with deep knowledge of camera functions.

Guru: For advanced users who make settings, including advanced features that can cause the camera to malfunction if not set correctly.

■ Selector

A Selector is used to index which instance of the feature is accessed in situations where multiple instances of a feature exist.

■ Instance Example:

Each Line-related item (LineSource, LineInverter, etc.) has LineSelector-LineX instances, which can be set or referenced as an index.

Selectors are a feature of element enumeration type (Enumeration) or an integer type (Integer). However, unlike normal configuration items, it is only used to select the instance in the following configuration item.

It does not change the behavior of the camera by changing the value of the selector. Also, the selector may have only one selectable value. In this case, use the selector function only for information purposes. In this document, it is described as SelectedFeature[Selector] according to the description method of GenICam.

In the case of Line Selector with a specific I/O line selected, the description could be as follows.

```
LineSource[LineSelector-LineX] = High  
LineInverter[LineSelector-LineX] = False  
LineMode[LineSelector-LineX] = Input  
LineFormat[LineSelector-LineX] = TTL
```

Generally, selectors only apply to a single category of features. (Example: TriggerSelector only applies to trigger related functions.)

DeviceControl

Display/configure information related to the device.

DeviceControl Item	Setting Range	Default Value	Description
DeviceScanType	-	0:Areascan	Display the device scan type.
DeviceVendorName	-	"JAI Corporation"	Display the manufacturer name.
DeviceModelName	-	-	Display the model name.
DeviceManufacturerInfo	-	See the possibilities	Display the manufacturer information.
DeviceVersion	-	-	Display the device version.
DeviceFirmwareVersion	-	-	Display the firmware version.
DeviceFpgaVersion			Display the FPGA version.
DeviceSerialNumber	-	-	Display the device ID.
DeviceUserID	Any	-	Set the user ID (16bytes) for the camera.
DeviceSFNCVersionMajor	-	2	Display the SFNC Major version.
DeviceSFNCVersionMinor	-	5	Display the SFNC Minor version.
DeviceSFNCVersionSubMinor	-	0	Display the SFNC Sub-Minor version.
DeviceManifestEntrySelector	1	1	Display the valid XML file information.
DeviceManifestXML MajorVersion	0 ~ 32bit max	0	Display XML file's major version number.
DeviceManifestXML MinorVersion	0 ~ 32bit max	0	Display XML file's minor version number.
DeviceManifestXML SubMinorVersion	0 ~ 32bit max	1	Display XML file's sub-minor version number.
DeviceManifestSchema MajorVersion	0 ~ 32bit max	1	Display XML file's sub-major version number.
DeviceManifestSchema MinorVersion	0 ~ 32bit max	1	Display schema file's minor version number.
DeviceManifest PrimaryURL	-	-	Display the PrimaryURL.
DeviceManifest SecondaryURL	-	-	Display the SecondaryURL.

User Manual (Ver. 1.3) - Setting List (Feature Properties)

GOX-5105MC-PGE | GOX-8105MC-PGE | GOX-12405MC-PGE | GOX-16205MC-PGE | GOX-20405MC-PGE | GOX-24505MC-PGE

DeviceControl Item	Setting Range	Default Value	Description
DeviceTLType	0:GigEVision (Fixed)	-	Transport Layer type of the device.
DeviceTLVersionMajor	2 (Fixed)	-	Indicates the major version number of the device's Transport Layer.
DeviceTLVersionMinor	0 (Fixed)	-	Indicates the minor version number of the device's Transport Layer.
DeviceTLVersionSubMinor	1 (Fixed)	-	Indicates the sub-minor version number of the device's Transport Layer.
DeviceLinkSelector	0 (Fixed)	0	Select Link.
DeviceLinkSpeed	-	125000000 Bps	Displays the negotiated transmission rate.
DeviceLinkHeartbeatMode	0:Off 1:On	1:On	Enable/Disable Heartbeat mode.
DeviceLinkHeartbeatTimeout	500000 ~ 120000000	3000000	Configure the timeout value for Heartbeat (unit: μ s). Step: 1000
DeviceStreamChannelCount	1 (Fixed)	-	Display the number of supported stream channels.
DeviceEventChannelCount	1 (Fixed)	-	Display the number of supported message channels.
DeviceCharacterSet	1: UTF8 (Fixed)	-	Display the character encoding.
DeviceReset	-	-	Reset the device. (After the camera receives this command, it returns an ACK response and executes the reset.)
DeviceRegistersEndianness	1:big-endian (Fixed)	-	Display the register's endianness.
DeviceTemperatureSelector	0: Mainboard 1: Sensor 2: FPGA	0: Mainboard	Select the area of the camera's interior for which to display the temperature sensor's reading.
DeviceTemperature	-55 ~ 125	0	Display the internal temperature ($^{\circ}$ C) of the device specified by DeviceTemperatureSelector.
Timestamp	0 ~ 64bit max	0	Display the timestamp value (ns). Resets to 0 when the signed maximum 64-bit value is exceeded.
TimestampReset	-	-	Forcibly sets the timestamp's count value to 0.
TimestampLatch	-	-	Sets the timestamp's count value to TimestampLatchValue.
TimestampLatchValue	0 ~ 64bit max	0	Maximum value Signed 64-bit max value.

DeviceControl Item	Setting Range	Default Value	Description
UserDefinedValueSelector	0: Value1 1: Value2 2: Value3 3: Value4 4: Value5	0: Value1	Five 32bit data can be set and saved.
UserDefinedValue	-2147483648 ~ 2147483647	0	Selects one of the 32bit data (Value1 to Value5) set in UserDefinedValueSelector, and reads and sets the value in UserDefinedValue.

TransportLayerControl

Display information on transport layer control.

TransportLayerControl Item	Setting Range	Default Value	Description
PayloadSize			Display the payload size. (Include ChunkData) (unit: bytes)
GigEVision			
GevPhysicalLinkConfiguration	-	0:Single Link (Fixed)	Display the LinkConfiguration status.

User Manual (Ver. 1.3) - Setting List (Feature Properties)

GOX-5105MC-PGE | GOX-8105MC-PGE | GOX-12405MC-PGE | GOX-16205MC-PGE | GOX-20405MC-PGE | GOX-24505MC-PGE

TransportLayerControl Item	Setting Range	Default Value	Description	
GevSupportedOptionSelector	-	0: SingleLink	Select the supported options for GigE Vision.	
			Link Configuration	0: SingleLink
			nif Configuration	4:PAUSEFrameReception, 5:PAUSEFrameGeneration, 6:IPConfigurationLLA, 7:IPConfigurationDHCP, 8:IPConfigurationPersistentIP
			GVCP	11:MessageChannelSourceSocket, 12:CommandsConcatenation, 13:WriteMem, 14:PacketResend, 15:Event, 17:PendingAck, 18:IEEE1588, 19:Action, 21:ScheduledAction, 23:ExtendedStatusCodes, 24:ExtendedStatusCodesVersion2_0, 28:ManifestTable, 29:CCPApplicationSocket, 30:LinkSpeed, 31:HeartbeatDisable, 32:SerialNumber, 33:UserDefinedName
GVSP	9:StreamChannelSourceSocket, 10:StandardIDMode			
GevSupportedOption	-	-	Displays whether the function selected by GevSupportOptionSelector is supported or not.	
GevInterfaceSelector		0: (Fixed)		
GevMACAddress	-	-	Display the MAC address.	
GevPAUSEFrameReception	-	1: TRUE (Fixed)		
GevPAUSEFrameTransmission	-	1: TRUE (Fixed)		
GevCurrentIPConfiguration LLA	-	1: TRUE (Fixed)	Display whether the current IP configuration is calibrated by LLA (link-local address).	
GevCurrentIPConfiguration DHCP	0: False 1: True	1: TRUE	Select whether to set the IP configuration to DHCP.	
GevCurrentIPConfiguration PersistentIP	0: False 1: True	0: FALSE	Select whether to set the IP configuration to Persistent IP.	
GevCurrentIPAddress	-	-	Display the IP address.	

User Manual (Ver. 1.3) - Setting List (Feature Properties)

GOX-5105MC-PGE | GOX-8105MC-PGE | GOX-12405MC-PGE | GOX-16205MC-PGE | GOX-20405MC-PGE | GOX-24505MC-PGE

TransportLayerControl Item	Setting Range	Default Value	Description
GevCurrentSubnetMask	-	-	Display the subnet.
GevCurrentDefaultGateway	-	-	Display the default gateway.
GevIPConfigurationStatus	-	2:DHCP	Display the current IP configuration status. Setting Range: 0:None , 1:PersistentIP, 2:DHCP, 3:LLA, 4:ForceIP
GevPersistentIPAddress	-	192.168.0.100	Set the persistent IP address.
GevPersistentSubnetMask	-	255.255.255.0	Set the persistent subnet mask.
GevPersistentDefaultGateway	-	0.0.0.0	Set the persistent default gateway.
NetworkThroughput SafetyMargin	10 - 100	92	For the configured LinkSpeed, set the limit to the bandwidth of the stream out of the camera (%). Caution: You can increase the frame rate by increasing this value. However, when set to more than 92 (default), abnormal images may be observed depending on the PC and its environment. If this happens, set the value to the default value (92).
GevIEEE1588 Related Topic: PTP (Precision Time Protocol)	0: False 1: True	0: FALSE	TRUE : Enables PTP FALSE: Disables PTP
GevIEEE1588ClockAccuracy	0 -20	19:Unknown	Indicates clock accuracy. Setting Range: 0:Within25ns, 1:Within100ns, 2:Within250ns, 3:Within1us, 4:Within2p5u, 5:Within10us, 6:Within25us, 7:Within100us, 8:Within250us, 9:Within1ms, 10:Within2p5ms, 11:Within10ms, 12:Within25ms, 13:Within100ms, 14:Within250ms, 15:Within1s, 16:Within10s, 17:GreaterThan10s, 18:AlternatePTPProfile, 19:Unknown, 20:Reserved
GevIEEE1588Status	-	-	Display the IEEE 1588 Status. 1:initializing, 2:faulty, 3:disabled, 4:listening, 5:preMaster, 6:master, 7:passive, 8:uncalibrated, 9:slave
GevGVCPExtendedStatus CodesSelector	0:Version1_ 1 1:Version2_ 0	0:Version1_1	Select the GevGVCPExtendedStatusCodes.

User Manual (Ver. 1.3) - Setting List (Feature Properties)

GOX-5105MC-PGE | GOX-8105MC-PGE | GOX-12405MC-PGE | GOX-16205MC-PGE | GOX-20405MC-PGE | GOX-24505MC-PGE

TransportLayerControl Item	Setting Range	Default Value	Description
GevGVCPEExtendedStatusCodes	-	-	Enables the generation of extended status codes.
GevGVCPPendingAck Step 6: Adjust the Image Quality	0: Off 1: On	0: Off	Enables/disables the PENDING_ACK.
GevGVSPExtendedIDMode	0: Off 1: On	0: Off	Enables/disables Extended ID Mode.
GevCCP	0 ~ 2	0:OpenAccess	Control access rights. 0:OpenAccess - Access rights have not been obtained by the application. 1:ExclusiveAccess - Once the application has made this setting, no other applications can control or reference the camera. 2:ControlAccess - Access rights have been obtained by the application. Other applications cannot control the camera, but can refer to it.
GevPrimaryApplicationSocket	-	-	Returns the UDP source port of the primary application.
GevPrimaryApplicationIPAddress	-	-	Returns the address of the primary application.
GevMCPHostPort	-	-	Controls the port to which the device must send messages. Setting this value to 0 closes the message channel.
GevMCDA	-	-	Controls the destination IP address for the message channel.
GevMCTT	0~ 4294967295 (ms)	0	Display/set the Transmission Timeout for Message Channel.
GevMCRC	0~ 4294967295	0	Display/set the Retry Count for Message Channel.
GevMCSP	-	-	This feature indicates the source port for the message channel.
GevStreamChannelSelector	0	0	Selects the stream channel to control.
GevSCCFGPacketResendDestination	0: False 1: True	0: FALSE	Enables the alternate IP destination for stream packets resent due to a packet resend request.
GevSCCFGAllInTransmission	0: False 1: True	0: FALSE	Enables the selected GVSP transmitter to use the single packet per data block All-in Transmission mode.

User Manual (Ver. 1.3) - Setting List (Feature Properties)

GOX-5105MC-PGE | GOX-8105MC-PGE | GOX-12405MC-PGE | GOX-16205MC-PGE | GOX-20405MC-PGE | GOX-24505MC-PGE

TransportLayerControl Item	Setting Range	Default Value	Description
GevSCCFGUnconditional Streaming	0: False 1: True	0: FALSE	Enables the camera to continue to stream, for this stream channel, if its control channel is closed or regardless of the reception of any ICMP messages (such as destination unreachable messages).
GevSCCFGExtended ChunkData	0: False 1: True	0: FALSE	Enables cameras to use the extended chunk data payload type for this stream channel.
GevSCPIInterfaceIndex	0	0 (Fixed)	Index of the logical link to use.
GevSCPHostPort	-	-	Controls the port of the selected channel to which a GVSP transmitter must send data stream or the port from which a GVSP receiver may receive a data stream. Setting this value to 0 closes the stream channel.
GevSCPSFireTestPacket	-	-	Sends a test packet. When this feature is set, the device will fire one test packet.
GevSCPSDoNotFragment	0: False 1: True	1: TRUE	The state of this feature is copied into the "do not fragment" bit of IP header of each stream packet. It can be used by the application to prevent IP fragmentation of packets on the stream channel.
GevSCPSPacketSize	1476 ~ 12036	1476	Specify the SCPS packet size (bytes).
GevSCPD	-	0	Controls the delay (in GEV timestamp counter unit) to insert between each packet for this stream channel. (step 8) Min: 0 Max: The value depends on the PixelFormat, Width, GevGVSPExtendedIDMode, GevSCPSPacketSize, NetworkThroughputSafetyMargin settings.
GevSCDA	-	-	Controls the destination IP address of the selected stream channel to which a GVSP transmitter must send data stream or the destination IP address from which a GVSP receiver may receive data stream.
GevSCSP	-	-	Indicates the source port of the stream channel.
NetworkStatistics	-	-	Category containing statistics about the different modules of the GigE Vision transport layer.
oMACControlFunctionEntity	-	-	Category containing statistics related to the device's MAC control PAUSE function.
aPAUSEMACCtrlFrames Received	0 ~ 32bit max	0	Displays the number of Pause frames received.

ImageFormatControl

Configure image format settings.

Note: Refer to [Functions That Cannot Be Used Together](#) for usage restrictions.

Image Format Control Item	Setting Range	Default Value	Description
SensorWidth			Display the maximum image width. GOX-5105MC-PGE: 2472 GOX-8105MC-PGE: 2856 GOX-12405MC-PGE: 4128 GOX-16205MC-PGE: 5328 GOX-20405MC-PGE: 4512 GOX-24505MC-PGE: 5328
SensorHeight			Display the maximum image height. GOX-5105MC-PGE: 2064 GOX-8105MC-PGE: 2848 GOX-12405MC-PGE: 3008 GOX-16205MC-PGE: 3040 GOX-20405MC-PGE: 4512 GOX-24505MC-PGE: 4608

User Manual (Ver. 1.3) - Setting List (Feature Properties)

GOX-5105MC-PGE | GOX-8105MC-PGE | GOX-12405MC-PGE | GOX-16205MC-PGE | GOX-20405MC-PGE | GOX-24505MC-PGE

Image Format Control Item	Setting Range	Default Value	Description
WidthMax			<p>Display the maximum image width.</p> <p>ImageCompressionMode = Off GOX-5105MC-PGE:2472 (1236) GOX-8105MC-PGE: 2856 (1428) GOX-12405MC-PGE: 4128 (2064) GOX-16205MC-PGE: 5328 (2664) GOX-20405MC-PGE: 4512 (2256) GOX-24505MC-PGE: 5328 (2664)</p> <p>ImageCompressionMode = Lossless GOX-5105MC-PGE:2432 (1152) GOX-8105MC-PGE: 2816 (1408) GOX-12405MC-PGE: 4096 (2048) GOX-16205MC-PGE: 5248 (2560) GOX-20405MC-PGE: 4480 (2176) GOX-24505MC-PGE: 5248 (2560)</p> <p>Note: For monochrome models, when BinningHorizontal = 2 or FD2x2BinningMode = On, the value in parenthesis is applicable.</p>
HeightMax			<p>Display the maximum image height.</p> <p>GOX-5105MC-PGE: 2064 (1032) GOX-8105MC-PGE: 2848 (1424) GOX-12405MC-PGE: 3008 (1504) GOX-16205MC-PGE: 3040 (1520) GOX-20405MC-PGE: 4512 (2256) GOX-24505MC-PGE: 4608 (2304)</p> <p>Note: For monochrome models, when BinningVertical = 2 or FD2x2BinningMode = On, the value in parenthesis is applicable.</p>

Image Format Control Item	Setting Range	Default Value	Description
<p>Width</p> <p>Related Topic: ROI Function (Single ROI)</p>	-	WidthMax value	<p>Set the image width.</p> <p>Note: This setting is available only when ImageScalingMode=Off.</p> <p>Setting Range:</p> <p>ImageCompressionMode = Off 96 (48)* ~ (WidthMax - OffsetX), Step 8(4)*</p> <p>*For monochrome models, when BinningHorizontal = 2 or FD2x2BinningMode = On, the value in parentheses is applicable.</p> <p>ImageCompressionMode = Lossless 128 ~ (WidthMax - OffsetX), Step 128</p>
<p>Height</p> <p>Related Topic: ROI Function (Single ROI)</p>	-	HeightMax value	<p>Set the image height.</p> <p>Note: This setting is available only when ImageScalingMode=Off.</p> <p>Setting Range: 8 (4)* ~ [HeightMax - OffsetY], Step 2(1)*</p> <p>*For monochrome models, when BinningVertical = 2 or FD2x2BinningMode = On, the value in parentheses is applicable.</p>
<p>OffsetX</p> <p>Related Topic: ROI Function (Single ROI)</p>	-	0	<p>Set the horizontal offset.</p> <p>Note: This setting is available only when ImageScalingMode=Off.</p> <p>Setting Range:</p> <p>ImageCompressionMode = Off 0 ~ (WidthMax - Width), Step 8(4)*</p> <p>*For monochrome models, when BinningHorizontal = 2 or FD2x2BinningMode = On, the value in parentheses is applicable</p> <p>ImageCompressionMode = Lossless 0 ~ (WidthMax - Width), Step 128</p>

Image Format Control Item	Setting Range	Default Value	Description
OffsetY Related Topic: ROI Function (Single ROI)	-	0	Set the vertical offset. Note: This setting is available only when ImageScalingMode=Off. Setting Range: 0 ~ [Height - Height], Step 2(1)* *For monochrome models, when BinningVertical = 2 or FD2x2BinningMode = On, the value in parentheses is applicable.
ROICentered Related Topic: ROICentered	0:Off 1:On	0:Off	When set to On, the image output position in the X direction is always forced to be centered and OffsetX is disabled.
FD2x2BinningMode Related Topic: Binning Function	0:Off 1:On	0:Off	Performs 2x2 analog binning (Sum processing). Monochrome models only.
BinningHorizontalMode Related Topic: Binning Function	0:Sum 1:Average	0:Sum	Set the processing method for horizontal binning. Monochrome models only.
BinningHorizontal	1 ~ 2	1	Set the number of pixels in the horizontal direction for which to perform binning. Monochrome models only.
BinningVerticalMode Related Topic: Binning Function	0:Sum 1:Average	0:Sum	Set the processing method for vertical binning. Monochrome models only.
BinningVertical	1 ~ 2	1	Set the number of pixels in the vertical direction for which to perform binning. Monochrome models only.
ImageScalingMode Related Topic: Image Scaling Mode (Xscale)	0:Off 1:On	0:Off	Enables Image Scaling Mode.
ImageScalingSumMode	0:Off (Ave) 1:On (Sum)	0:Off (Ave)	Selects whether to use Sum or Average mode when ImageScalingMode is On.

User Manual (Ver. 1.3) - Setting List (Feature Properties)

GOX-5105MC-PGE | GOX-8105MC-PGE | GOX-12405MC-PGE | GOX-16205MC-PGE | GOX-20405MC-PGE | GOX-24505MC-PGE

Image Format Control Item	Setting Range	Default Value	Description
ImageScalingHorizontal	0.0625 ~ 1	1	Specifies the horizontal scaling ratio in decimal units. For example, if you want to scale the image by 50% in the horizontal direction, specify "0.5".
ImageScalingHorizontalAbs	256 ~ 4096	-	Indicates the horizontal scaling ratio as an integer value (rounded down to the nearest whole number). The formula is: ImageScalingHorizontal X 4096.
ImageScalingVertical	0.0625 ~ 1	1	Specifies the vertical scaling ratio in decimal units. For example, if you want to scale the image by 50% in the vertical direction, specify "0.5".
ImageScalingVerticalAbs	256 ~ 4096	-	Indicates the vertical scaling ratio as an integer value (rounded down to the nearest whole number). The formula is: ImageScalingVertical X 4096.
ImageScalingBaseAbs	-	4096 (Fixed)	
DecimationHorizontalMode	-	0: Discard (Fixed)	Set Decimation Horizontal mode.
DecimationHorizontal Related Topic: Decimation Mode	-	1: None	<p>If set to 2, Pixels(50%) are thinned out horizontally.</p> <p>1: None 2: Pixels are thinned out horizontally</p> <p>Note: DecimationHorizontal and DecimationVertical cannot be set separately. For example, changing DecimationHorizontal to 2 will automatically change DecimationVertical to 2.</p>
DecimationVerticalMode	-	0: Discard (Fixed)	Set Decimation Vertical mode.
DecimationVertical Related Topic: Decimation Mode	-	1: None	<p>If set to 2, Pixels(50%) are thinned out vertically.</p> <p>1: None 2: Pixels are thinned out vertically.</p> <p>Note: DecimationHorizontal and DecimationVertical cannot be set separately. For example, changing DecimationHorizontal to 2 will automatically change DecimationVertical to 2.</p>

Image Format Control Item	Setting Range	Default Value	Description
ReverseX Related Topic: Image Flip Function	0 ~ 1	0	Reverse pixels horizontally.
ReverseY Related Topic: Image Flip Function	0 ~ 1	0	Reverse pixels vertically.
SensorDigitizationBits Related Topic: SensorDigitizationBits	8: 8 Bits 10: 10 Bits 12: 12 Bits	10: 10 Bits	Select the sensor output bits.
PixelFormat (Mono models) Related Topic: Pixel Format	-	Mono8	Set the pixel format. 0x01080001: Mono8 (Default) 0x01100003: Mono10 0x010C0004: Mono10Packed 0x01100005: Mono12 0x010C0006: Mono12Packed

Image Format Control Item	Setting Range	Default Value	Description
PixelFormat (Color models) Related Topic: Pixel Format	-	BayerRG8	Color Models 0x01080009: BayerRG8 (Default) 0x0110000D: BayerRG10 0x010C0027: BayerRG10Packed 0x01100011: BayerRG12 0x010C002B: BayerRG12Packed 0x01080008: BayerGR8* 0x0110000C: BayerGR10* 0x010C0026: BayerGR10Packed* 0x01100010: BayerGR12* 0x010C002A: BayerGR12Packed* 0x0108000A: BayerGB8* 0x0110000E: BayerGB10* 0x10C0028: BayerGB10Packed* 0x01100012: BayerGB12* 0x010C002C: BayerGB12Packed* 0x0108000B: BayerBG8* 0x0110000F: BayerBG10* 0x010C0029: BayerBG10Packed* 0x01100013: BayerBG12* 0x010C002D: BayerBG12Packed* 0x02180014: RGB8** 0x0220001C: RGB10V1Packed** 0x0220001D: RGB10p32** Notes: <ul style="list-style-type: none"> • *When using the Image Flip Function • **Utilizes 5x5 Debayering.
GradationCompression Mode Related Topic: Gradation Compression Mode	0: Off 1: On	0: Off	Enables the sensor's gradation compression function.
GradationCompression 1stKneePoint	-	50	Set the first knee point of the sensor's gradation compression function in percentage. Setting Range (%): 0, 6.25, 12.5, 25, 50, 100 Max Value: 0 or the GradationCompression2ndKneePoint value, whichever is smaller.

User Manual (Ver. 1.3) - Setting List (Feature Properties)

GOX-5105MC-PGE | GOX-8105MC-PGE | GOX-12405MC-PGE | GOX-16205MC-PGE | GOX-20405MC-PGE | GOX-24505MC-PGE

Image Format Control Item	Setting Range	Default Value	Description
GradationCompression1stGain	-	0	Set the first knee compression rate for the sensor's gradation compression function in dB. Setting Range (dB): 0, -6, -12, -18, -24, -30, -36, -42, -48, -54, -60, -66
GradationCompression2ndKneePoint	-	100	Set the second knee point of the sensor's gradation compression function in percentage. Setting Range (%): 6.25, 12.5, 25, 50, 100, 200, 400, 800 Min Value: GradationCompression1stKneePoint. However, when GradationCompression1stKneePoint is set to 0, Min = 6.25
GradationCompression2ndGain	-	0	Set the second knee compression rate for the sensor's gradation compression function in dB. Setting Range (dB): 0, -6, -12, -18, -24, -30, -36, -42, -48, -54, -60, -66
TestPattern	-	0: Off	Select the test image. 0: Off (Default) 1: GreyHorizontalRamp 4: HorizontalColorBar (Color models only)
ImageCompressionMode Related Topic: Image Compression Mode (Xpress)	0: Off 1: Lossless	0: Off	Enable/Disable Image Compression Mode.
OverlayMode Related Topic: Overlay Mode	-	0: Off	You can check the target area by reducing the brightness of the non-target area to 50%. 0: Off (Default) 1: MultiRoiAreaMode - Check the active area on MultiROI. 2: ALCAreaMode - Check the photometry area on ALC. 3: AWBAreaMode - Check the photometry area on AWB.

MultiROIControl

Configure settings for Multi ROI.

Related Topic: [ROI Function \(Multi ROI\)](#)

Note: Refer to [Functions That Cannot Be Used Together](#) for usage restrictions.

Multi ROI Control Item	Setting Range	Default Value	Description
MultiRoiMode	0:Off 1:On	0	Enable/disable Multi Roi.
MultiRoiIndex	0 ~ 7	0	Select the index for the Multi Roi mode.
MultiRoiWidth	-	-	Set the width for the selected Multi Roi index. Setting Range: 96 ~ [WidthMax - MultiRoiOffsetX], Step 8 Default GOX-5105MC-PGE: 304 GOX-8105MC-PGE: 352 GOX-12405MC-PGE: 512 GOX-16205MC-PGE: 664 GOX-20405MC-PGE: 560 GOX-24505MC-PGE: 664
MultiRoiHeight	-	-	Set the height for the selected Multi Roi index. Setting Range: 8 ~ [HeightMax - MultiRoiOffsetY], Step 2 Default GOX-5105MC-PGE: 258 GOX-8105MC-PGE: 356 GOX-12405MC-PGE: 376 GOX-16205MC-PGE: 380 GOX-20405MC-PGE: 564 GOX-24505MC-PGE: 576
MultiRoiOffsetX	-	-	Set the horizontal offset for the selected Multi Roi index. Min: The minimum value of the range where each Index does not overlap. Max: The maximum value of the range where each Index does not overlap. Step: 8 Default: (Index number - 1) x MultiRoiWidth

Multi ROI Control Item	Setting Range	Default Value	Description
MultiRoiOffsetY	-	-	Set the vertical offset for the selected Multi Roi index. Min: The minimum value of the range where each Index does not overlap. Max: The maximum value of the range where each Index does not overlap. Step: 2 Default: (Index number - 1) x MultiRoiHeight
MultiRoiHorizontal EnableNumber	1 ~ 8	1	Set the maximum number of valid horizontal index numbers.
MultiRoiVertical EnableNumber	1 ~ 8	1	Set the maximum number of valid vertical index numbers.

AcquisitionControl

Configure image capture settings.

Acquisition Control Item	Setting Range	Default Value	Description
AcquisitionMode Related Topic: Acquisition Control	0:SingleFrame 1:MultiFrame 2:Continuous	2:Continuous	Select the image capture mode.
AcquisitionStart	-	-	Start image capture.
AcquisitionStop	-	-	Stop image capture.
AcquisitionFrameCount	1 ~ 65535	1	In MultiFrame mode, set the number of frames to capture.

User Manual (Ver. 1.3) - Setting List (Feature Properties)

GOX-5105MC-PGE | GOX-8105MC-PGE | GOX-12405MC-PGE | GOX-16205MC-PGE | GOX-20405MC-PGE | GOX-24505MC-PGE

Acquisition Control Item	Setting Range	Default Value	Description
AcquisitionFrameRate Related Topic: Changing the Frame Rate	0.125 ~	-	Display the frame rate as a frequency (unit: Hz). The maximum value varies depending on the Width, Height, PixelFormat, SensorDigitizationBits, Binning (Horizontal/Vertical), FD2x2BinningMode, ImageScalingMode, Decimation (Horizontal/Vertical), ChunkModeActive, GevSCPSPacketSize, GevSCPD, GevGVSPExtendedIDMode, NetworkThroughputSafetyMargin settings. Default GOX-5105MC-PGE: 21 fps GOX-8105MC-PGE: 12 fps GOX-12405MC-PGE: 8 fps GOX-16205MC-PGE: 6 fps GOX-20405MC-PGE: 5 fps GOX-24505MC-PGE: 4 fps Notes: <ul style="list-style-type: none"> The fastest FPS value when set to: SensorDigitizationBits = 10bit, PixelFormat = 8bit., NetworkThroughputSafetyMargin = 92, Packet Size = 1476 Byte, ExtendedIDMode = Off. See Features for the fastest frame rate achievable on this camera.
TriggerSelector Related Topic: Trigger Control	0:AcquisitionStart 1:AcquisitionEnd 2:FrameStart 3:Acquisition TransferStart	0:AcquisitionStart	Select the trigger operation.
TriggerMode	0:Off 1:On	0:Off	Select the trigger mode.
TriggerSoftware	-	-	Execute a software trigger.
TriggerSource	-	24: Line5 Opt In	Select the trigger signal source. 7-10: PulseGenerator0-3 11-14: UserOutput0 -3 15-18: Action0-3 19:Software 24: Line5 Opt In 36: Nand0 Out 37: Nand1 Out

Acquisition Control Item	Setting Range	Default Value	Description
TriggerActivation	1:Rising Edge 2:Falling Edge 3:Level High 4:Level Low	1:Rising Edge	Select the polarity of the trigger signal (i.e., location of signal at which trigger is applied).
TriggerOverlap	0: Off (fixed) 1: ReadOut	-	Select the trigger overlap operation. TriggerSelector (AcquisitionStart/AcquisitionEnd/AcquisitionTransferStart) = 0:Off (Fixed) TriggerSelector(FrameStart) = 1: ReadOut
TriggerDelay	0 - 500000	0	Set the time of exposure start from trigger input. (unit: μ s)
ExposureMode Related Topic: Exposure Mode	0: Off 1: Timed 2: TriggerWidth	1: Timed	Select the exposure mode.
ExposureTime (us) Related Topic: Actual Exposure Time	-	-	Set the exposure time (us). Note: The actual exposure time will consist of the image sensor's offset duration (2.45us) added to the ExposureTime setting. Min: 1 Max: (1/AcquisitionFrameRateMax) - Next trigger prohibited time. Default: GOX-5105MC-PGE: 47098 GOX-8105MC-PGE: 76482 GOX-12405MC-PGE: 113900 GOX-16205MC-PGE: 148889 GOX-20405MC-PGE: 189422 GOX-24505MC-PGE: 225724 Note: ExposureTime at the fastest FPS value when SensorDigitizationBits=10bit, PixelFormat=8bit, NetworkThroughputSafetyMargin=92, Packet size = 1476 Byte.
ExposureAuto	0: Off 1:Once 2:Continuous	0: Off	Set whether to enable auto exposure. When set to Once, the automatic adjustment will be performed only once, and then automatically switched to Off.

Acquisition Control Item	Setting Range	Default Value	Description
ExposureModeOption	0: Off 1: RCT 2: BurstTrigger	0: Off	Enables RCT mode or BurstTrigger mode. Related Topic: RCT Mode , Burst Trigger Mode

DigitalIOControl

Configure settings for digital input/output.

Related Topic: [GPIO \(Digital Input/Output Settings\)](#)

Digital IO Control Item	Setting Range	Default Value	Description
LineSelector	-	21: Line2 Opt Out1	Select the input/output to configure. 21: Line2 Opt Out1 24: Line5 Opt In1 53: Nand0 In1 54: Nand0 In2 55: Nand1 In1 56: Nand1 In2 63: TimestampReset
LineMode	-	-	Display the input/output status (whether it is input or output). 0: Input (LineSelector=24,53,54,55,56) 1: Output (LineSelector=21) 2: InternalConnection (LineSelector=63)
LineInverter	0: False 1: True	0: False	Enable/disable polarity inversion for the selected input signal or output signal. Note: LineSelector=24,63 are fixed to "0".
LineStatus	0: False 1: True	0: False	Display the status of the input signal or output signal (True: High, False: Low).

User Manual (Ver. 1.3) - Setting List (Feature Properties)

GOX-5105MC-PGE | GOX-8105MC-PGE | GOX-12405MC-PGE | GOX-16205MC-PGE | GOX-20405MC-PGE | GOX-24505MC-PGE

Digital IO Control Item	Setting Range	Default Value	Description
LineSource	-	-	<p>Select the line source signal for the item selected in LineSelector.</p> <p>0: Off (Only when LineSelector is set to TimestampReset) 1: AcquisitionActive 2: FrameActive 4: ExposureActive 5: FVAL 7-10: PulseGenerator0-3 11-14: UserOutput0-3 15-18: Action0-3 (only when LineSelector=TimestampReset) 24: Line5 Opt In1 36: Nand0 Out 37: Nand1 Out 40: - (Not selectable for Output and NAND In) 41: Low 42: High 43: AcquisitionTriggerWait 44: FrameTriggerWait</p> <p>※LineSelector=24 is fixed to "-".</p> <p>Default LineSelector=TimestampReset: Off(0) LineSelector=Other than TimestampReset: Line5 Opt In1 (24)</p>
LineFormat	-	-	<p>Display the signal format.</p> <p>2: TTL 5: OptoCoupled 7: Internal Signal</p> <p>Default LineSelector=21,24: OptoCoupled LineSelector=53,54,55,56,63: Internal Signal</p>
LineStatusAll	-	-	<p>Display the input/output signal status. The state is shown with 16 bits. Bit assignments are as follows.</p> <p>bit0: Unused (Fixed to 0) bit1: Line2 bit2 - 3: Unused (Fixed to 0) bit4: Line5 bit5 - 11: Unused (Fixed to 0) bit12: Nand0 In1 bit13: Nand0 In2 bit14: Nand1 In1 bit15: Nand1 In2</p>

Digital IO Control Item	Setting Range	Default Value	Description
OptInFilter (ns)	0 ~ 40000000	0	Remove noise from the OptIn input signal of Digital I/O. Step: 100 Setting Range: 0 ~ 40ms
UserOutput Selector	-	0: User Output 0	Set the UserOutput signal. 0: User Output 0 1: User Output 1 2: User Output 2 3: User Output 3
UserOutput Value	0: False 1: True	0: False	Set the value for the UserOutput selected in UserOutputSelector.

PulseGenerator

Configure pulse generator settings.

Related Topic: [Pulse Generator](#)

Pulse Generator Item	Setting Range	Default Value	Description
ClockPreScaler	1 ~ 4096	297	Set the division value for the prescaler (12 bit) using PixelClock as the base clock.
PulseGeneratorClock (MHz)	-	0.25	Set the clock used for the pulse generator. This value is calculated using the [ClockPreScaler] value as a base. PulseGeneratorClock = SrcFreq / ClockPreScaler SrcFreq:74.25
PulseGeneratorSelector	0:PulseGenerator0 1:PulseGenerator1 2:PulseGenerator2 3:PulseGenerator3	0:PulseGenerator0	Select the pulse generator.
PulseGeneratorLength	1 ~ 1048575	25000	Set the maximum count-up value as a clock count.
PulseGeneratorLengthMs (ms)	-	100	Set the maximum count-up value in milliseconds. This value is calculated using the PulseGeneratorLength value as a base. The setting range varies depending on the ClockPreScaler value. PulseGeneratorLengthMs = 1/PulseGeneratorClock * PulseGeneratorLength

User Manual (Ver. 1.3) - Setting List (Feature Properties)

GOX-5105MC-PGE | GOX-8105MC-PGE | GOX-12405MC-PGE | GOX-16205MC-PGE | GOX-20405MC-PGE | GOX-24505MC-PGE

Pulse Generator Item	Setting Range	Default Value	Description
PulseGeneratorFrequency (Hz)	-	10	Set the maximum count-up value as a frequency. This value is calculated using the PulseGeneratorLength value as a base. $\text{PulseGeneratorFrequency} = 1\text{sec} / \text{PulseGeneratorLengthMs}$
PulseGeneratorStartPoint	0 ~ 1048575	0	Set the start point of the High interval as a clock count. When the counter reaches this value, the output will be 1.
PulseGeneratorStartPointMs (ms)	-	0	Set the start point of the High interval in milliseconds. When the counter reaches this value, the output will be 1. The setting range varies depending on the ClockPreScaler value. $\text{PulseGeneratorStartPointMs} = 1 / \text{PulseGeneratorClock} * \text{PulseGeneratorStartPoint}$
PulseGeneratorEndPoint	1 ~ 1048575	12500	Set the start point of the Low interval as a clock count. When the counter reaches this value, the output will be 0.
PulseGeneratorEndPointMs (ms)	-	50	Set the start point of the Low interval in milliseconds. When the counter reaches this value, the output will be 0. The setting range varies depending on the ClockPreScaler value. $\text{PulseGeneratorEndPointMs} = 1 / \text{PulseGeneratorClock} * \text{PulseGeneratorEndPoint}$
PulseGeneratorPulseWidth (ms)	-	50	Display the High interval width of the pulse in milliseconds. The duration between the Start Point and End Point is calculated. The setting range varies depending on the ClockPreScaler value. $\text{PulseGeneratorPulseWidth} = 1 / \text{PulseGeneratorClock} * (\text{PulseGeneratorEndPoint} - \text{PulseGeneratorStartPoint})$
PulseGeneratorRepeat Count	0 ~ 255	0	Set the repeat count for the counter. When this is set to 0, a free counter is enabled with no repeat limit.
PulseGeneratorClear Activation	0: Off 1: Rising Edge 2: Falling Edge 3: Level High 4: Level Low	0: Off	Set the clear signal condition for the count clear input of the pulse generator.

User Manual (Ver. 1.3) - Setting List (Feature Properties)

GOX-5105MC-PGE | GOX-8105MC-PGE | GOX-12405MC-PGE | GOX-16205MC-PGE | GOX-20405MC-PGE | GOX-24505MC-PGE

Pulse Generator Item	Setting Range	Default Value	Description
PulseGeneratorClear Source	-	24: Line5 Opt In1	Select the count clear input signal source. 1: AcquisitionActive 2: FrameActive 4: ExposureActive 5: FVAL 7-10: PulseGenerator0-3(*) 11-14: UserOutput0-3 24: Line5 Opt In1 36: Nand0 Out 37: Nand1 Out 43: AcquisitionTriggerWait 44: FrameTriggerWait Note: (*)Disabled if the PulseGenerator is selected in PUlseGeneratorSelector.
PulseGeneratorClear SyncMode	0:Async Mode 1:Sync Mode	0:Async Mode	Select the sync mode for the count clear input signal.

AnalogControl

Configure the analog control settings.

Analog Control Item	Setting Range	Default Value	Description
GainSelector Related Topic: Gain Control	0: Analog All 1: Digital Red 3: Digital Blue	0:Analog All	Select the gain to configure. Note: DigitalRed and DigitalBlue are available only for color models.
Gain	-	1	Set the gain value for the gain setting selected in GainSelector. Note: DigitalRed and DigitalBlue are available only for color models. Unit:Magnification AnalogAll: Min=1.0, Max=126.0 , Step= 0.1dB DigitalRed/DigitalBlue: Min=0.447, Max=5.624, Step=0.000122 (Color model only)
GainAuto	0: Off 1: Once 2: Continuous	0: Off	Enable/disable gain auto adjustment. Once automatically changes to Off when the signal level converges once.
BlackLevelSelector	0: All 1: Red 3: Blue	0: All	Select the black level to configure. Note: DigitalRed and DigitalBlue are available only for color models.
BlackLevel	-	0	Set the black level value. All: Min=-133, Max=255 Red: Min=-64, Max=64 Blue: Min=-64, Max=64 Note: Red and Blue are available only for color models.

Analog Control Item	Setting Range	Default Value	Description
BalanceWhiteAuto	-	0: Off	<p>Enable/disable auto white balance. When set to Once, the automatic adjustment will be performed only once, and then automatically switched to Off.</p> <p>Note: Color models only.</p> <p>0: Off 1: Once 2: Continuous 5: Preset 3200K 6: Preset 5000K 7: Preset 6500K 8: Preset 7500K</p>
			<p>Related Topic: White Balance</p>
AWBAreaSelector	-	0: Low Right	<p>Select the area for which to configure AWBAreaEnable.</p> <p>Note: Color models only.</p> <p>0: Low Right 1: Low Mid-Right 2: Low Mid-Left 3: Low Left 4: Mid-Low Right 5: Mid-Low Mid-Right 6: Mid-Low Mid-Left 7: Mid-Low Left 8: Mid-High Right 9: Mid-High Mid-Right 10: Mid-High Mid-Left 11: Mid-High Left 12: High Right 13: High Mid-Right 14: High Mid-Left 15: High Left</p>
AWBAreaEnable	0: False 1: True	1: True	Enable/disable the photometry area selected in AWBAreaSelector.
AWBAreaEnableAll	0: False 1: True	1: True	<p>True: Operate BalanceWhiteAuto with all areas designated as photometry areas, regardless of the individual enabled/disabled photometry area states configured in AWBAreaSelector.</p> <p>False: Operate BalanceWhiteAuto according to the individual enabled/disabled photometry area states configured in AWBAreaSelector.</p>
AWBControlSpeed	1 ~ 8	4	Set the response speed for BalanceWhiteAuto. (8 is the fastest)

Analog Control Item	Setting Range	Default Value	Description
BalanceWhiteAuto Result	-	0: Idle	<p>Display the results of BalanceWhiteAuto.</p> <p>Note: Color models only.</p> <p>0: Idle 1: Processing 2: Converging 3: Succeeded 4: Error1 - G image was too bright 5: Error2 - G image was too dark 6: Error3 - Timeout 7: Error4 - could not processing 8: Error5 - R or B image was out of range</p>
Gamma	0.45 ~ 1	0.45	<p>Set the gamma value.</p> <p>Setting Range: 0.45, 0.50, 0.55, 0.60, 0.65, 0.75, 0.80, 0.90, 1.00</p>
LUTMode	0: Off 1: Gamma 2: LUT	0:Off	Select the LUT mode.

LUTControl

Configure LUT settings.

Related Topic: [LUT \(Lookup Table\)](#)

LUT Control Item	Setting Range	Default Value	Description
LUTSelector	0: Red 1: Green 2: Blue	0: Red	<p>Select the LUT channel to control.</p> <p>Note: Color models only.</p>
LUTIndex	0 ~ 256	0	Set the LUT index table number.
LUTValue	0 ~ 4095	Gamma≡ 1.0	Set the LUT value.

AutoLevelControl

Configure AutoLevelControl.

Related Topic: [ALC \(Automatic Level Control\) Function](#)

Auto Level Control Item	Setting Range	Default Value	Description
ALCControlReference	-	1: Selected Channel	<p>Sets the channel to be used for ALC control reference.</p> <p>Note: Color models only.</p> <p>0: Peak Channel 1: Selected Channel</p>
ALCControlChannel	0: Red 1: Green 2: Blue	1: Green	<p>When ALCControlReference is set to SelectedChannel, this setting determines which RGB channel signal is used for ALC control.</p> <p>When ALCControlReferenc is set to PeakChannel, this setting is disabled.</p> <p>Note: Color models only.</p>
ALCReference	5 ~ 95	50	Set the target level for ALC. (unit: %)
ALCAreaSelector	-	0: Low Right	<p>Select the area for which to configure ALCAreaEnable.</p> <p>0: Low Right 1: Low Mid-Right 2: Low Mid-Left 3: Low Left 4: Mid-Low Right 5: Mid-Low Mid-Right 6: Mid-Low Mid-Left 7: Mid-Low Left 8: Mid-High Right 9: Mid-High Mid-Right 10: Mid-High Mid-Left 11: Mid-High Left 12: High Right 13: High Mid-Right 14: High Mid-Left 15: High Left</p>
ALCAreaEnable	0: False 1: True	1: True	Enable/disable the photometry area selected in ALCAreaSelector.

Auto Level Control Item	Setting Range	Default Value	Description
ALCAreaEnableAll	0: False 1: True	1: True	True: Operate ALC with all areas designated as photometry areas, regardless of the individual enabled/disabled photometry area states configured in ALCAreaSelector. False: Operate ALC according to the individual enabled/disabled photometry area states configured in ALCAreaSelector.
ALCControlRatio	1 ~ 100	90	Set the response speed (%). (100 is the fastest.)
AutoControlStatus	-	0: Idle	Allows confirmation of the AGC, ASC, and AWB convergence status. 0: Idle 1: Processing - Exposure Time 2: Processing - Gain 3: Converging - Exposure Time 4: Converging - Gain 5: Error1 - could not processing 6: Error2 - timeout
ExposureAutoControlMin	-	100	Set the minimum value for the ExposureTime control range. (us) Min: 100 Max: ExposureTimeMax-1
ExposureAutoControlMax	-	ExposureTimeMax*	Set the maximum value for the ExposureTime control range. (us) Min: ExposureAutoControlMin+1 Max: ExposureTimeMax
GainAutoControlMin	-	1	Set the minimum value for the GainAuto control range. (Step ≙ 0.1dB) Min: 1 Max: (GainAutoControlMax - 1)
GainAutoControlMax	-	126	Set the maximum value for the GainAuto control range. (Step ≙ 0.1dB) Min: GainAutoControlMin+1 Max: 126

Note: *ExposureTimeMax: The maximum exposure time value under the current setting conditions.

ColorTransformationControl

Configure color transformation settings.

Related Topic: [Color Space Conversion \(ColorTransformationControl\)](#)

Color Transformation Control Item	Setting Range	Default Value	Description
ColorTransformationMode	0:RGB 2:XYZ	0:RGB	Set the output image format.
ColorTransformationRGBMode	0: OFF 1: sRGB 2: AdobeRGB 3: UserCustom	0: OFF	Set the detailed mode when RGB is selected for the color space.
ColorMatrixValueSelector	0: R-R 1: R-G 2: R-B 3: G-R 4: G-G 5: G-B 6: B-R 7: B-G 8: B-B	0: R-R	Select the ColorMatrix setting component.
ColorMatrixValue	-2 ~ 2	-	Set the Color Matrix value. (Step = 0.1) Default: ColorMatrixValueSelector=0,4,8: 1.0 ColorMatrixValueSelector=1,2,3,5,6,7: 0

ImagingControl

Configure other JAI functions.

Imaging Control Item	Setting Range	Default Value	Description
VideoProcessBypassMode Related Topic: VideoProcessBypassMode	0: Off 1: On	0: Off	Enable/disable VideoProcessBypass mode.
EdgeEnhancerEnable Related Topic: Edge Enhancer , Color Enhancer	0: Off 1: On	0: Off	Enable/disable EdgeEnhancer. Note: Monochrome models only.
EdgeEnhancerLevel	0: Low 1: Middle 2: High 3: Strong	1: Middle	Set the Level for EdgeEnhancer. Note: Monochrome models only.
ColorEnhancerEnable Related Topic: Edge Enhancer , Color Enhancer	0: Off 1: On	0: Off	Enable/disable ColorEnhancer.
ColorEnhancerSelector	0: Red 1: Cyan 2: Green 3: Magenta 4: Blue 5: Yellow	0:Red	Index for configuring detailed settings of ColorEnhancer.
ColorEnhancerValue	0 ~ 1.0	0	Set the enhancement to one of ten levels for each color element. (Step = 0.1) 0: No enhancement

ShadingControl

Configure shading correction settings.

Related Topic: [Shading Correction](#)

Shading Control Item	Setting Range	Default Value	Description
ShadingCorrectionMode	-	0: Flat Shading	Select the shading correction method. 0: Flat Shading 1: Color Shading (Color models only)
ShadingMode	0: Off 1: User1 2: User2 3: User3	0: Off	Set the area to which to save shading correction data. When this is set to Off, PerformShadingCalibration will not be executed.
PerformShadingCalibration	-	-	Execute shading correction. This command can not be executed under the following conditions. - When outputting no image. - When outputting TestPattern. - Width and/or Height are less than 512 (ROI Function (Single ROI)) - In FD2x2Binning mode (Binning Function) - In ImageScaling mode (Image Scaling Mode (Xscale)) - In Decimation mode (Decimation Mode) - In Sequencer mode (Sequencer Function) - In MultiRoi mode (ROI Function (Multi ROI)) - In Reverse mode (Image Flip Function) - In GradationCompression mode (Gradation Compression Mode) - In ALC mode (ALC (Automatic Level Control) Function) - AcquisitionMode is set to other than Continuous (AcquisitionControl)
ShadingDetectResult	-	0: Idle	Display the shading correction results. 0: Idle 1: Succeeded 2: Error1 - image was too bright 3: Error2 - image was too dark 4: Error3 - could not calibrated 5: Error4 - correction limit 6: Error5 - timeout

BlemishControl

Configure settings for JAI white blemish correction.

Related Topic: [BlemishCompensation](#)

Blemish Control Item	Setting Range	Default Value	Description
BlemishEnable	-	1: Enable	Enable/disable blemish correction. 0: Disable all 1: Enable 2 :Disable user detection
BlemishDetect	-	-	Execute blemish detection. This command cannot be executed under the following conditions. - No image is being output. - TestPattern is being output - In Sequencer Mode (Sequencer Function) - In MultiRoi mode (ROI Function (Multi ROI)) - The image is not full ROI size (ROI Function (Single ROI)) - In Reverse mode (Image Flip Function) - GradationCompressionMode is not Off (Gradation Compression Mode) - AcquisitionMode is not Continuous (Acquisition Control) - Not in lens cap state
BlemishDetectionResult	-	0	Display the blemish detection results. 0: Idle 1: Succeeded 2: Error1 - image was too bright 3: Error2 - image was too dark (unused) 4: Error3 - signal level was unbalanced (unused) 5: Error4 - detect blemishes too many 6: Error5 - could not detected 7: Error6 - timeout
BlemishDetectThreshold	1 ~ 99	10	Set the blemish detection threshold.
BlemishStore	-	-	Save the location information of detected blemishes, manually specified by BlemishiCompensationPositionX and BlemishCompensationPositionY.
BlemishCompensationIndex	1 ~ 2000	1	Select the index for the target blemish coordinates.

Blemish Control Item	Setting Range	Default Value	Description
BlemishCompensation PositionX	-	-1	Display the X coordinate (horizontal pixel position) of the target blemish selected in BlemishCompensationIndex. You can also manually enter the X coordinate of the blemish you want to correct. Min: -1 Max: WidthMax - 1
BlemishCompensation PositionY	-	-1	Display the Y coordinate (vertical pixel position) of the target blemish selected in BlemishCompensationIndex. You can also manually enter the Y coordinate of the blemish you want to correct. Min: -1 Max: HeightMax - 1
BlemishCompensation DataClear	-	-	Delete detected or specified blemish information selected in BlemishCompensationIndex.
BlemishCompensationNumber	0 ~ 2000	0	Display the number of target blemishes.

SequencerControl

Configure sequencer settings.

Related Topic: [Sequencer Function](#)

Note: Refer to [Functions That Cannot Be Used Together](#) for usage restrictions.

Sequencer Control Item	Setting Range	Default Value	Description
SequencerMode	0: Off 1: On	0: Off	Enable/disable SequencerMode. If this function is set from Off to On when any one of the following conditions is met, this function will not be enabled: <ul style="list-style-type: none"> - ReverseX/Y = True - DecimationHorizontal/DecimationVertical = 2 - FD2x2BinningMode = On - ImageScalingMode = On - MultiRoiMode = On - GradationCompressionMode = On - ROICentered = On

User Manual (Ver. 1.3) - Setting List (Feature Properties)

GOX-5105MC-PGE | GOX-8105MC-PGE | GOX-12405MC-PGE | GOX-16205MC-PGE | GOX-20405MC-PGE | GOX-24505MC-PGE

Sequencer Control Item	Setting Range	Default Value	Description
SequencerModeSelect	-	0	Select the sequencer mode. 0: TriggerSequencerMode (Default) 1: CommandSequencerMode
SequencerSetSelector	1 ~ 32	1	Select the index number to configure.
SequencerWidth	-	WidthMax value	Set the width of the selected SequencerIndex. Setting Range: 96 (48)* ~ [WidthMax - OffsetX] , Step 8(4)* *For monochrome models, when BinningHorizontal = 2, the value in parentheses is applicable.
SequencerHeight	-	HeightMax value	Set the height of the selected SequencerIndex. Setting Range: 8 (4)* ~ [HeightMax - OffsetY], Step 2(1)* *For monochrome models, when BinningVertical = 2 or FD2x2BinningMode = On, the value in parentheses is applicable.
SequencerOffsetX	-	0	Set the horizontal offset value for the selected SequencerIndex. Setting Range: 0 ~ [WidthMax - Width], Step 8(4)* *For monochrome models, when BinningHorizontal = 2, the value in parentheses is applicable.
SequencerOffsetY	-	0	Set the vertical offset value for the selected SequencerIndex. Setting Range: 0 ~ [Height - Height], Step 2(1)* *For monochrome models, when BinningVertical = 2, the value in parentheses is applicable.
SequencerFrameCount	1 ~ 65535	1	Set the FrameCount value for the selected SequencerIndex. Note: The same value with AcquisitionFrameCount (AcquisitionControl)
SequencerExposureTime	1 ~ 8000000	-	Set the exposure time for the selected SequencerIndex. Default: ExposureTimeMax* (AcquisitionControl)
SequencerGainAnalogAll	1.0 ~ 126.0	1	Set the Gain[AnalogAll] value for the selected SequencerIndex. Note: The same value with Gain[AnalogAll] (AnalogControl)

Sequencer Control Item	Setting Range	Default Value	Description
SequencerGainDigitalRed	0.447 ~ 5.624	1	Set the Gain[DigitalRed] value for the selected SequencerIndex. Note: The same value with Gain[DigitalRed] (AnalogControl). Color models only.
SequencerGainDigitalBlue	0.447 ~ 5.624	1	Set the Gain[DigitalBlue] value for the selected SequencerIndex. Note: The same value with Gain[DigitalBlue] (AnalogControl). Color models only.
SequencerLUTEnable	0: False 1: True	0: False	Set the LutEnable value for the selected SequencerIndex.
SequencerSetNext	0 ~ 32	-	Set the next index to be displayed for the selected SequencerIndex. (Enabled only for TriggerSequencer.) If 0 is specified, the operation of the Sequencer is stopped. SequencerSetSelector = 1 ~ 31: (SequencerSetSelector+1) SequencerSetSelector = 32: 1
SequencerRepetition	1 ~ 255	1	Set the repeat count for the sequencer.
SequencerSetActive	1 ~ 32	1	Displays the active index number.
SequencerSetStart	1 ~ 32	1	Specify the first index number to switch to when starting TriggerSequencerMode.
SequencerCommandIndex	1 ~ 32	1	Set this to change the SequencerIndex. (Enabled only for CommandSequencer.)
SequencerReset	-	-	In TriggerSequencerMode, reset the current index number to the number configured in SequencerSetStart.

Note: *ExposureTimeMax: The maximum exposure time value under the current setting conditions.

CounterAndTimerControl

Configure counter settings.

Note: This camera only supports the counter functions.

Related Topic: [Counter and Timer Control Function](#)

Counter and Timer Control Item	Setting Range	Default Value	Description
CounterSelector	0: Counter0 1: Counter1 2: Counter2 3: Counter3	0: Counter0	Select the counter.
CounterEventSource	-	0: Off	Assign the Counter Event signal for which you want to read the count value to a dedicated counter, and read the value. 0: Off 1: FrameTrigger (Counter0 only) 2: Exposure Start (Counter1 only) 3: Sensor Readout (Counter2 only) 4: FrameTransferEnd (Counter3 only)
CounterEventActivation	1:Rising Edge 2:Falling Edge	-	Set the count timing. The setting value is fixed with the following data. Default: CounterSelector=0, 1, 2: Rising Edge CounterSelector=3: Falling Edge
CounterReset	-	-	Reset the counter.
CounterValue	0 ~ 32bit max	0	Display the count value.
CounterStatus	-	0: CounterIdle	Display the counter status. 0: CounterIdle 1: CounterTriggerWait 2: CounterActive 3: CounterCompleted 4: CounterOverflow - Count value exceeded the maximum value

ActionControl

Configures action control settings.

Related Topic: [Action Control Function](#)

Action Control Item	Setting Range	Default Value	Description
ActionDeviceKey	0x00000000 ~ 0xFFFFFFFF	0x00000000	An action command is executed if this ActionDeviceKey matches the DeviceKey contained in the action command message.
ActionQueueSize			Displays the queue size of ScheduledActionCommand. This value represents the maximum number of ScheduledActionCommands that can be pending at the time a ScheduledActionCommand is given in time.
ActionSelector	0:Off 1:On	0:Off	Select the ActionSelector.
ActionGroupMask	0x00000000 ~ 0xFFFFFFFF	0x00000000	An action command is executed if the result of an AND operation of GroupMask contained in this ActionGroupMask and an action command message is not 0.
ActionGroupKey	0x00000000 ~ 0xFFFFFFFF	0x00000000	An action command is executed if this ActionGroupKey matches the GroupKey contained in the action command message.

EventControl

Configure settings for event control.

Related Topic: [Event Control Function](#)

Event Control Item	Setting Range	Default Value	Description
EventSelector	-	0: Acquisition Trigger	Select the event to send the event message. 0: AcquisitionTrigger 1: FrameStart 2: FrameEnd 5: ExposureStart 6: ExposureEnd
EventNotification	0: Off 1: On	0: Off	Sets whether or not to send an event message when an event selected by EventSelector occurs.
EventAcquisitionTriggerData	-	-	When the event AcquisitionTrigger occurs, the following three data can be checked.
EventAcquisitionTrigger	-	0x9002	Displays the EventID (0x9002).
EventAcquisitionTriggerTimestamp	0 ~ 64bit max	0	Displays the Timestamp value when an event occurs.
EventAcquisitionTriggerFrameID	-	0 (Fixed)	Displays the FrameID value when an event occurs.
EventFrameStartData	-	-	When the event FrameStartData occurs, the following three data can be checked.
EventFrameStart	-	0x9300	Displays the EventID (0x9300).
EventFrameStartTimestamp	0 ~ 64bit max	0	Displays the Timestamp value when an event occurs.
EventFrameStartFrameID	-	0 (Fixed)	Displays the FrameID value when an event occurs.
EventFrameEndData	-	-	When the event FrameEndData occurs, the following three data can be checked.
EventFrameEnd	-	0x9301	Displays the EventID (0x9301).
EventFrameEndTimestamp	0 ~ 64bit max	0	Displays the Timestamp value when an event occurs.
EventFrameEndFrameID	-	0 (Fixed)	Displays the FrameID value when an event occurs.
EventExposureStartData	-	-	When the event ExposureStartData occurs, the following three data can be checked.

User Manual (Ver. 1.3) - Setting List (Feature Properties)

GOX-5105MC-PGE | GOX-8105MC-PGE | GOX-12405MC-PGE | GOX-16205MC-PGE | GOX-20405MC-PGE | GOX-24505MC-PGE

Event Control Item	Setting Range	Default Value	Description
EventExposureStart	-	0x9003	Displays the EventID (0x9003).
EventExposureStartTimestamp	0 ~ 64bit max	0	Displays the Timestamp value when an event occurs.
EventExposureStartFrameID	-	0 (Fixed)	Displays the FrameID value when an event occurs.
EventExposureEndData	-	-	When the event ExposureEndData occurs, the following three data can be checked.
EventExposureEnd	-	0x9004	Displays the EventID (0x9004).
EventExposureEndTimestamp	0 ~ 64bit max	0	Displays the Timestamp value when an event occurs.
EventExposureEndFrameID	-	0 (Fixed)	Displays the FrameID value when an event occurs.

ChunkDataControl

Configure Chunk Control settings.

Related Topic: [Chunk Data Function](#)

Chunk Data Control Item	Setting Range	Default Value	Description
ChunkModeActive	0: Off 1: On	0: Off	Set whether to enable ChunkData.
ChunkOffsetX	-	-	Display the OffsetX value (ImageFormatControl) ChunkID: 0x00002000
ChunkOffsetY	-	-	Display the OffsetY value (ImageFormatControl) ChunkID: 0x00002001
ChunkWidth	-	-	Display the Width value (ImageFormatControl) ChunkID: 0x00002002
ChunkHeight	-	-	Display the Height value (ImageFormatControl) ChunkID: 0x00002003
ChunkLineStatusAll	-	-	Display the LineStatusAll value (DigitalIOControl) ChunkID: 0x00002013
ChunkExposureTime	-	-	<p>Display the ExposureTime value (us). ChunkID: 0x00002004</p> <p>Note: The value displayed in ChunkExposureTime includes the exposure offset value (2us).</p> <p>ChunkExposureTime: <i>ExposureTime</i> (AcquisitionControl) value + 2us</p>
ChunkGainSelector	0: Analog All 1: Digital Red 2: Digital Blue	0: Analog All	Select the Gain to configure.
ChunkGain	-	-	<p>Display the Gain value (AnalogControl)</p> <p>0: Analog All - ChunkID: 0x0000201F 1: Digital Red - ChunkID: 0x00002006 3: Digital Blue - ChunkID: 0x00002007</p>
ChunkFrameTriggerCounter	-	-	Display the value for CounterValue[Counter0] (CounterAndTimerControl). Data acquisition timing is FrameStart. ChunkID: 0x0000200E
ChunkSequencerSetActive	-	-	Displays the SequencerSet number currently set in TriggerSequenceMode or CommandSequencerMode. (1 is displayed in Normal Mode.) (SequencerControl) ChunkID: 0x0000200C

TestControl

Configure the test control setting.

Test Control Item	Setting Range	Default Value	Description
TestPendingAck	0 ~ 10000	0	PendingAck function test command. The camera waits for TestPendingAck (ms) time and returns an Ack response.

UserSetControl

Configure user settings.

Related Topic: [Step 7: Save the Settings](#)

User Set Control Item	Setting Range	Default Value	Description
UserSetSelector	-	0: Default	Select the user settings. 0: Default - Invalid when executing UserSetSave 1: User1 2: User2 3: User3
UserSetLoad	-	-	Read the user settings specified in UserSetSelector. When selecting Default for UserSetSelector, the factory settings are loaded.
UserSetSave	-	-	Overwrite the current setting values with the user settings specified in UserSetSelector. Invalid when UserSetSelector is set to Default.

Miscellaneous

Troubleshooting

Check the following before requesting help. If the problem persists, contact your local JAI distributor.

Power Supply and Connections

Issue: The POWER/TRIG LED remains lit amber and does not turn green, even after power is supplied to the camera.

Cause and Solution:

- Camera initialization may not be complete due to a lack of power. Check the 6-pin power cable connection.

Or the GigE connection may be not established. Check the ethernet cable connection.

Image Display

Issue: Gradation in dark areas is not noticeable.

Cause and Solution: Use the gamma function to correct the display. As the light-emitting properties of the monitor are not linear, the entire image may be darker or the gradation in the dark areas may be less noticeable when camera outputs are displayed without processing. Using the gamma function performs correction to produce a display that is close to linear. For details, see [Gamma Function](#).

Settings and Operations

Issue: Settings cannot be saved to user memory.

Cause and Solution: You cannot save to user memory while images are being acquired by the camera. Stop image acquisition before performing the save operation.

Issue: I want to restore the factory default settings.

Cause and Solution: Load Default under User Set Selector in the Feature Properties tab to restore the factory default settings.

Specifications

Item	Monochrome	Color	
Scanning System	Progressive scan, 1 tap		
Synchronization	Internal		
Interface	1000BASE-T Ethernet (GigE Vision 2.0), IEEE 802.3af		
Image Sensor	Monochrome CMOS	Bayer Color CMOS	
Dark SN	>60 dB@10bit		
	Conditions:		
	GOX-5105MC-PGE	AnalogGainAll:x1.0,Shutter:OFF, SensorDigitizationBits=12bit, Mono10/Bayer10, Frame Rate: 14.5fps	
	GOX-8105MC-PGE	AnalogGainAll:x1.0,Shutter:OFF, SensorDigitizationBits=12bit, Mono10/Bayer10, Frame Rate: 9.1fps	
	GOX-12405MC-PGE	AnalogGainAll:x1.0,Shutter:OFF, SensorDigitizationBits=12bit, Mono10/Bayer10, Frame Rate: 6.0fps	
	GOX-16205MC-PGE	AnalogGainAll:x1.0,Shutter:OFF, SensorDigitizationBits=12bit, Mono10/Bayer10, Frame Rate: 4.0fps	
	GOX-20405MC-PGE	AnalogGainAll:x1.0,Shutter:OFF, SensorDigitizationBits=12bit, Mono10/Bayer10, Frame Rate: 3.6fps	
	GOX-24505MC-PGE	AnalogGainAll:x1.0,Shutter:OFF, SensorDigitizationBits=12bit, Mono10/Bayer10, Frame Rate: 3.0fps	
Bright SN	>38 dB	>36 dB(Gch)	
Image Size (Effective Image)	GOX-5105MC-PGE	Type 1/1.8	6.8 mm x 5.7 mm (8.82mm diagonal)
	GOX-8105MC-PGE	Type 2/3	7.8 mm x 7.8 mm (11.05mm diagonal)
	GOX-12405MC-PGE	Type 1/1.1	11.3 mm x 8.2 mm (14.00mm diagonal)
	GOX-16205MC-PGE	Type 1.1	14.6 mm x 8.3 mm (16.81mm diagonal)
	GOX-20405MC-PGE	Type 1.1	12.4 mm x 12.4 mm (17.48mm diagonal)
	GOX-24505MC-PGE	Type 1.2	14.6 mm x 12.6 mm (19.30mm diagonal)
Pixel Size	2.74 μm x 2.74 μm		

Item	Monochrome	Color		
Effective Image Pixel	GOX-5105MC-PGE: 2472 x 2064 GOX-8105MC-PGE: 2856 x 2848 GOX-12405MC-PGE: 4128 x 3008 GOX-16205MC-PGE: 5328 x 3040 GOX-20405MC-PGE: 4512 x 4512 GOX-24505MC-PGE: 5328 x 4608			
Acquisition Frame Rate (Max) Mono8, BayerRG8, BayerGR8, BayerGB8, BayerBG8			PacketSize: 1476	PacketSize: 12036
	GOX-5105MC-PGE	21fps	22fps	
	GOX-8105MC-PGE	13fps	13fps	
	GOX-12405MC-PGE	8fps	9fps	
	GOX-16205MC-PGE	6fps	6fps	
	GOX-20405MC-PGE	5fps	5fps	
	GOX-24505MC-PGE	4fps	4fps	
	<p>Note: SensorDigitizationBits is set to 10Bits, NetworkThroughputSafetyMargin is set to 92, Packet Size is 1476, ExtendedIDMode = Off.</p>			
Acquisition Frame Rate (Max) Mono10Packed, Mono12Packed, BayerRG10Packed, BayerRG12Packed, BayerGR10Packed, BayerGE12Packed, BayerGB10Packed, BayerGB12Packed, BayerBG10Packed, BayerBG12Packed			PacketSize: 1476	PacketSize: 12036
	GOX-5105MC-PGE	14 fps	14 fps	
	GOX-8105MC-PGE	8 fps	9 fps	
	GOX-12405MC-PGE	5 fps	6 fps	
	GOX-16205MC-PGE	4 fps	4 fps	
	GOX-20405MC-PGE	3 fps	3 fps	
	GOX-24505MC-PGE	2 fps	3 fps	
	<p>Notes:</p> <ul style="list-style-type: none"> • SensorDigitizationBits is set to 10Bits, NetworkThroughputSafetyMargin is set to 92, Packet Size is 1476, ExtendedIDMode = Off. • If SensorDigitizationBits is set to smaller than the pixel format bits configured in the Pixel Format, the image may have gaps in the histogram. 			

Item	Monochrome		Color	
Acquisition Frame Rate (Max) Mono10, Mono12, BayerRG10, BayerRG12, BayerGR10, BayerGB12, BayerGB10, BayerGB12, BayerBG10, BayerBG12		PacketSize: 1476	PacketSize: 12036	
	GOX-5105MC-PGE	10 fps	11 fps	
	GOX-8105MC-PGE	6 fps	6 fps	
	GOX-12405MC-PGE	4 fps	4 fps	
	GOX-16205MC-PGE	3 fps	3 fps	
	GOX-20405MC-PGE	2 fps	2 fps	
	GOX-24505MC-PGE	2 fps	2 fps	
	<p>Notes:</p> <ul style="list-style-type: none"> • SensorDigitizationBits is set to 10Bits, NetworkThroughputSafetyMargin is set to 92, Packet Size is 1476, ExtendedIDMode = Off. • If SensorDigitizationBits is set to smaller than the pixel format bits configured in the Pixel Format, the image may have gaps in the histogram. 			
Acquisition Frame Rate (Max) RGB8		PacketSize: 1476	PacketSize: 12036	
	GOX-5105C-PGE	7 fps	7 fps	
	GOX-8105C-PGE	4 fps	4 fps	
	GOX-12405C-PGE	2 fps	3 fps	
	GOX-16205C-PGE	2 fps	2 fps	
	GOX-20405C-PGE	1 fps	1 fps	
	GOX-24505C-PGE	1 fps	1 fps	
	<p>Note: SensorDigitizationBits is set to 10Bits, NetworkThroughputSafetyMargin is set to 92, Packet Size is 1476, ExtendedIDMode = Off.</p>			

Item	Monochrome	Color	
Acquisition Frame Rate (Max) RGB10V1Packed, RGB10p32		PacketSize: 1476	PacketSize: 12036
	GOX-5105C-PGE	5 fps	5 fps
	GOX-8105C-PGE	3 fps	3 fps
	GOX-12405C-PGE	2 fps	2 fps
	GOX-16205C-PGE	1 fps	1 fps
	GOX-20405C-PGE	1 fps	1 fps
	GOX-24505C-PGE	1 fps	1 fps
	<p>Notes:</p> <ul style="list-style-type: none"> • SensorDigitizationBits is set to 10Bits, NetworkThroughputSafetyMargin is set to 92, Packet Size is 1476, ExtendedIDMode = Off. • If SensorDigitizationBits is set to smaller than the pixel format bits configured in the Pixel Format, the image may have gaps in the histogram. 		
Digital Image Output Format - Full	GOX-5105MC-PGE: 2472 x 2064 GOX-8105MC-PGE: 2856 x 2848 GOX-12405MC-PGE: 4128 x 3008 GOX-16205MC-PGE: 5328 x 3040 GOX-20405MC-PGE: 4512 x 4512 GOX-24505MC-PGE: 5328 x 4608		
Digital Image Output Format - ROI (Width)	GOX-5105MC-PGE: 96(48) to 2472 (1236), step 8(4) GOX-8105MC-PGE: 96(48) to 2856(1428), step 8(4) GOX-12405MC-PGE: 96(48) to 4128 (2064), step 8(4) GOX-16205MC-PGE: 96(48) to 5328 (2664), step 8(4) GOX-20405MC-PGE: 96(48) to 4512 (2256), step 8(4) GOX-24505MC-PGE: 96(48) to 5328 (2664), step 8(4)		
<p>Note: For monochrome models, when BinningHorizontal = 2 or FD2x2BinningMode = On, the value in parenthesis is applicable.</p>			

Item	Monochrome	Color
Digital Image Output Format - ROI (Offset X)	<p>GOX-5105MC-PGE: 0 to [2472 (1236) - Width], step 8(4) GOX-8105MC-PGE: 0 to [2856(1428) - Width], step 8(4) GOX-12405MC-PGE: 0 to [4128 (2064) - Width], step 8(4) GOX-16205MC-PGE: 0 to [5328 (2664) - Width], step 8(4) GOX-20405MC-PGE: 0 to [4512 (2256) - Width], step 8(4) GOX-24505MC-PGE: 0 to [5328 (2664) - Width], step 8(4)</p> <p>Note: For monochrome models, when BinningHorizontal = 2 or FD2x2BinningMode = On, the value in parenthesis is applicable.</p>	
Digital Image Output Format - ROI (Height)	<p>GOX-5105MC-PGE: 8(4) to 2064 (1032), step2(1) GOX-8105MC-PGE: 8(4) to 2848 (1424), step2(1) GOX-12405MC-PGE: 8(4) to 3008 (1504), step2(1) GOX-16205MC-PGE: 8(4) to 3040 (1520), step2(1) GOX-20405MC-PGE: 8(4) to 4512 (2256), step2(1) GOX-24505MC-PGE: 8(4) to 4608 (2304), step2(1)</p> <p>Note: For monochrome models, when BinningVertical = 2 or FD2x2BinningMode = On, the value in parenthesis is applicable.</p>	
Digital Image Output Format - ROI (Offset Y)	<p>GOX-5105MC-PGE: 0 to [2064 (1032) - Height], step2(1) GOX-8105MC-PGE: 0 to [2848 (1424) - Height], step2(1) GOX-12405MC-PGE: 0 to [3008 (1504) - Height], step2(1) GOX-16205MC-PGE: 0 to [3040 (1520) - Height], step2(1) GOX-20405MC-PGE: 0 to [4512 (2256) - Height], step2(1) GOX-24505MC-PGE: 0 to [4608 (2304) - Height], step2(1)</p> <p>Note: For monochrome models, when BinningHorizontal = 2 or FD2x2BinningMode = On, the value in parenthesis is applicable.</p>	
Digital Image Output Format: Binning (H) = 1 and FD2x2BinningMode = Off	<p>GOX-5105M-PGE: 2472 GOX-8105M-PGE: 2856 GOX-12405M-PGE: 4128 GOX-16205M-PGE: 5328 GOX-20405M-PGE: 4512 GOX-24505M-PGE: 5328</p>	N/A
Digital Image Output Format: Binning (H) = 2 or FD2x2BinningMode = On	<p>GOX-5105M-PGE: 1236 GOX-8105M-PGE: 1428 GOX-12405M-PGE: 2064 GOX-16205M-PGE: 2664 GOX-20405M-PGE: 2256 GOX-24505M-PGE: 2664</p>	N/A

Item	Monochrome	Color
Digital Image Output Format: Binning (V) = 1 and FD2x2BinningMode = Off	GOX-5105M-PGE: 2064 GOX-8105M-PGE: 2848 GOX-12405M-PGE: 3008 GOX-16205M-PGE: 3040 GOX-20405M-PGE: 4512 GOX-24505M-PGE: 4608	N/A
Digital Image Output Format: Binning (V) = 2 or FD2x2BinningMode = On	GOX-5105M-PGE: 1032 GOX-8105M-PGE: 1424 GOX-12405M-PGE: 1504 GOX-16205M-PGE: 1520 GOX-20405M-PGE: 2256 GOX-24505M-PGE: 2304	N/A
Digital Image Output Format: Pixel Format	Mono8 (default), Mono10, Mono10Packed, Mono12, Mono12Packed	BayerRG8 (default), BayerRG10, BayerRG10Packed, BayerRG12, BayerRG12Packed, BayerGR8*, BayerGR10*, BayerGR10Packed*, BayerGR12*, BayerGR12Packed*, BayerGB8*, BayerGB10*, BayerGB10Packed*, BayerGB12*, BayerGB12Packed*, BayerBG8*, BayerBG10*, BayerBG10Packed*, BayerBG12*, BayerBG12Packed*, RGB8, RGB10V1Packed, RGB10p32 Note: * When ReverseX/ReverseY is On.
Acquisition Mode	Continuous / SingleFrame / MultiFrame (1 ~ 65535)	
Trigger Selector	Acquisition: AcquisitionStart / AcquisitionEnd Exposure: FrameStart Transfer: AcquisitionTransferStart(Delayed readout)	
Opto Filter	0 ~ 40ms, Step 100ns	
Trigger Overlap	Off / Read out	
Trigger Input Signals	PulseGenerator0-3, UserOutput0-3, Action0-3, Software, Line5 Opt In, Nand0 Out, Nand1 Out	
Exposure Mode	Timed (FrameStartTrigger Off): 3.45* μ s ~ ExposureTimeMax (The maximum exposure time value under the current setting conditions.) Timed (FrameStartTrigger On): 3.45* μ s ~ 8Sec TriggerWidth: 3.45* μ s ~ ∞ Note: *Including the exposure offset duration (2.45 μ s).	
Auto Exposure (Exposure Auto)	Off / Continuous / Once	

Item	Monochrome	Color
Auto Exposure Response Speed (ALCControlRatio)	1 ~ 100%	
Digital I/O	LineSelector (6P): GPIO IN / GPIO OUT	
Black Level Adjustment	Default Level: 8LSB@8bit All (Mono/Color): -133 ~ +255 LSB Red (Color): -64 ~ +64 LSB Blue (Color): -64 ~ +64 LSB Resolution Adjustment: 1LSB@12bit	
Gain Adjustment	Manual Adjustment Range: AnalogAll (Mono/Color): 0db ~ 42dB DigitalRed (Color): -7dB ~ 15dB DigitalBlue (Color): -7dB ~ 15dB Adjustment Auto Gain: Off, Continuous, Once	
White Balance	WhiteBalanceGain: DigitalRed, DigitalBlue :0.447 ~ 5.624, 1STEP = x 0.0001 BalanceWhiteAuto: Off, Continuous, Once, Preset3200K, Preset5000K, Preset6500K, Preset7500K Photometry Area: 16 (4 x 4) Area Adjustment Range: 3000K ~ 9000K	
Blemish Correction	<p>Detection: Detect white blemishes using threshold values (100 steps available) (black blemish correction performed only at the factory)</p> <p>Correction: Interpolation using adjacent pixels. Continuous blemishes can be corrected up to 3 horizontal pixels (up to 3 horizontal pixels of the same Bayer color, for color models).</p> <p>Correctable pixels: 2000 pixels</p>	
ALC	Video level adjusted automatically using AGC and ASC	
Gamma	0.45, 0.5, 0.55, 0.6 ,0.65, 0.75, 0.8, 0.9, 1.0 (9 steps available)	
LUT	OFF: $\gamma = 1.0$, ON = 257 points can be set	
Vibration Resistance	10G (20 Hz ~ 200 Hz X-Y-Z direction)	
Impact Resistance	80G	
Power Supply	PoE:	Input Range: DC +36 ~ +57V Consumption: 4.5W typical (Default setting/ 25 °C Environment/ DC 48 V Input) @48 V, 133mA/6.4W (Max)
	6-pin Connector:	Input Range: DC +10V ~ +25V Consumption: 3.4 W typical (Default setting/ 25 °C Environment/ DC 12 V Input) @ +12 V, 490mA/4.8W (Max)

Item	Monochrome	Color
Lens Mount	<ul style="list-style-type: none"> • C-Mount • Lens mount protrusion length of 9 mm or less is supported. 	
Flange Back	17.526mm, tolerance: 0 mm ~ -0.05 mm	
Optical Filter	IR cut filter (color model only)	
Verified Performance Temperature/Humidity	-5°C ~ +45°C / 20 % ~ 80 % (non-condensing) Note: It may change depending on the installation environment. Please refer to the Cautions in the Package Contents section.	
Storage Temperature/Humidity	-25°C ~ +60°C / 20 % ~ 80 % (non-condensing)	
Regulations (Tentative)	CE [EN 55032:2015(CISPR32:2015) Class B, EN 55035:2017 (CISPR35:2016)], FCC Part 15 Class B, EU RoHS/WEEE, China RoHS, KC	
Housing	29mm x 29mm x 55mm (WHD, excluding connectors)	
Weight	70 g	

Package Contents

- Camera (1)
- Sensor protection cap (1)
- Dear customer (sheet) (1)

Optional Accessories (Sold Separately)

- MP-46 Tripod Adapter Plate

Notes:

- Design and specifications are subject to change without notice.
- Approximately 30 minutes of warm-up are required to achieve these specifications.

Cautions:

The performance specifications given for this camera have been verified for the Operating Temperature range shown in the Specifications table. The camera may be able to perform outside of the specified temperature range, but such performance has not been verified and is therefore not guaranteed.

- The camera's internal temperature should not exceed 72 °C during operation.

If the above temperature conditions are exceeded, take measures to dissipate heat according to your installation environment and conditions.

Spectral Response (GOX-5105M-PGE/GOX-5105C-PGE)

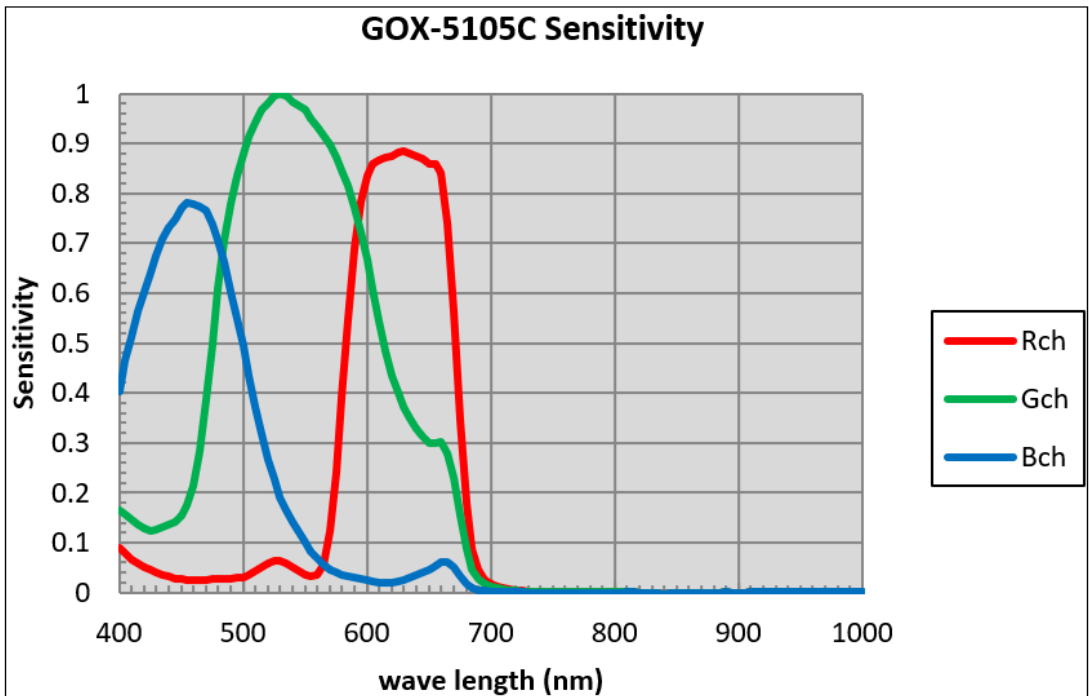
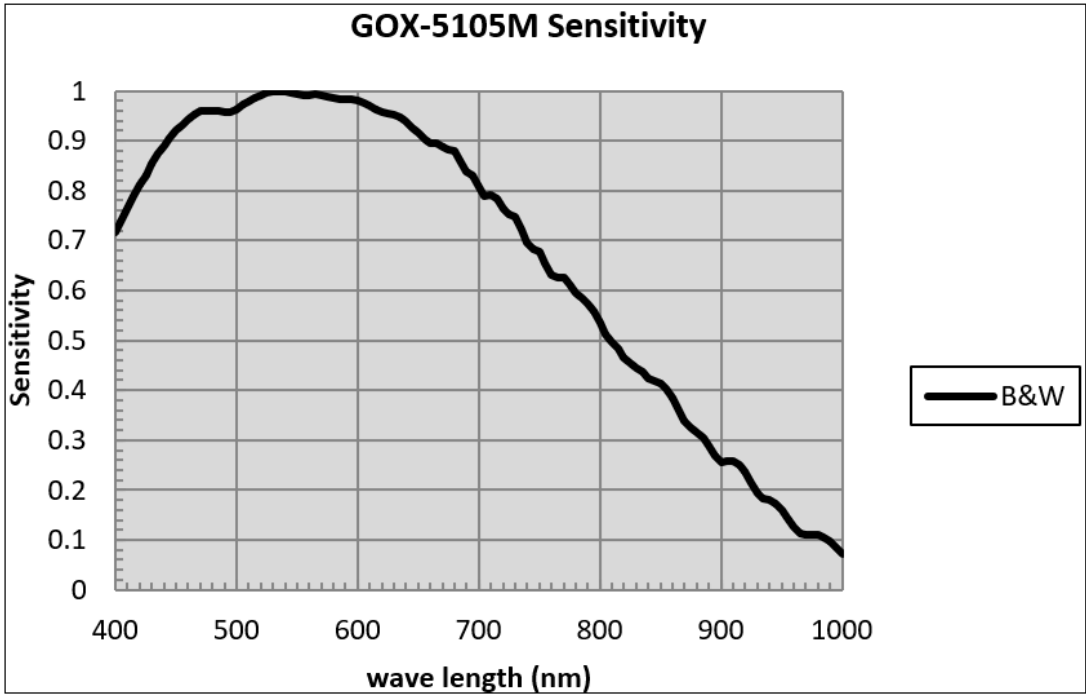

Spectral Response (GOX-8105M-PGE/GOX-8105C-PGE)

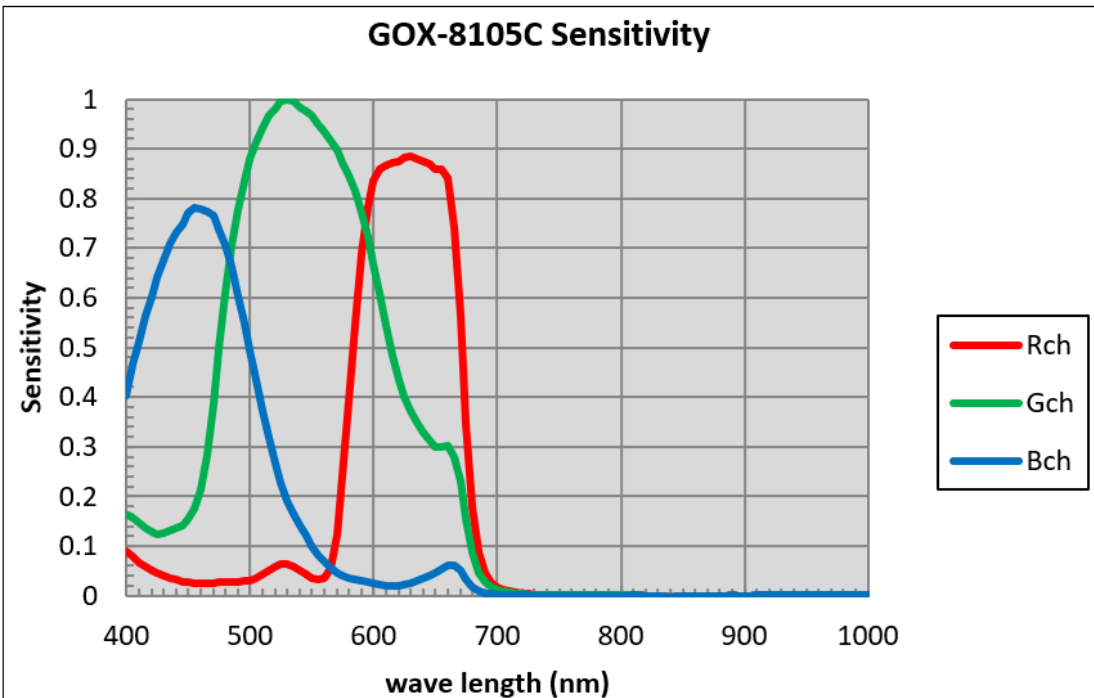
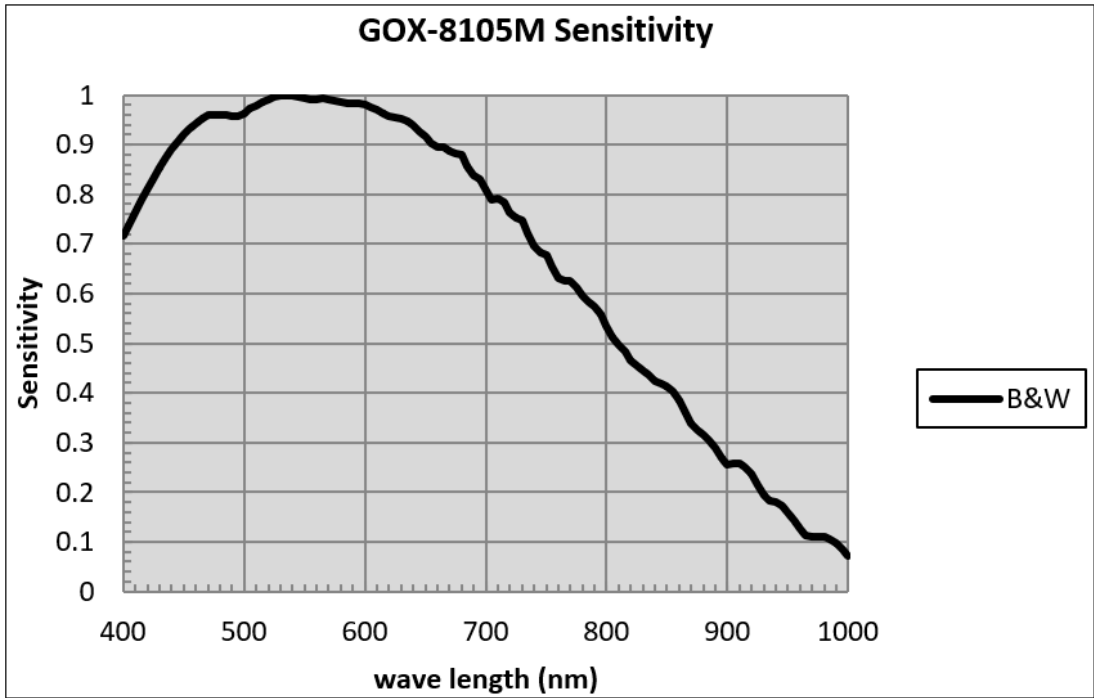

Spectral Response (GOX-12405M-PGE/GOX-12405C-PGE)

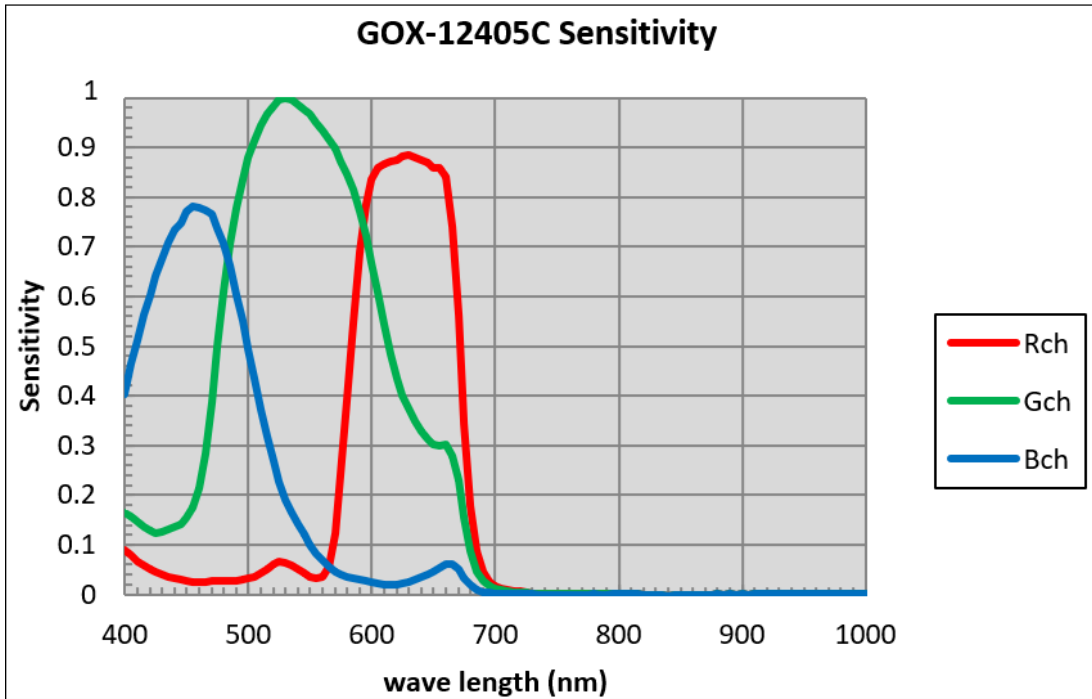
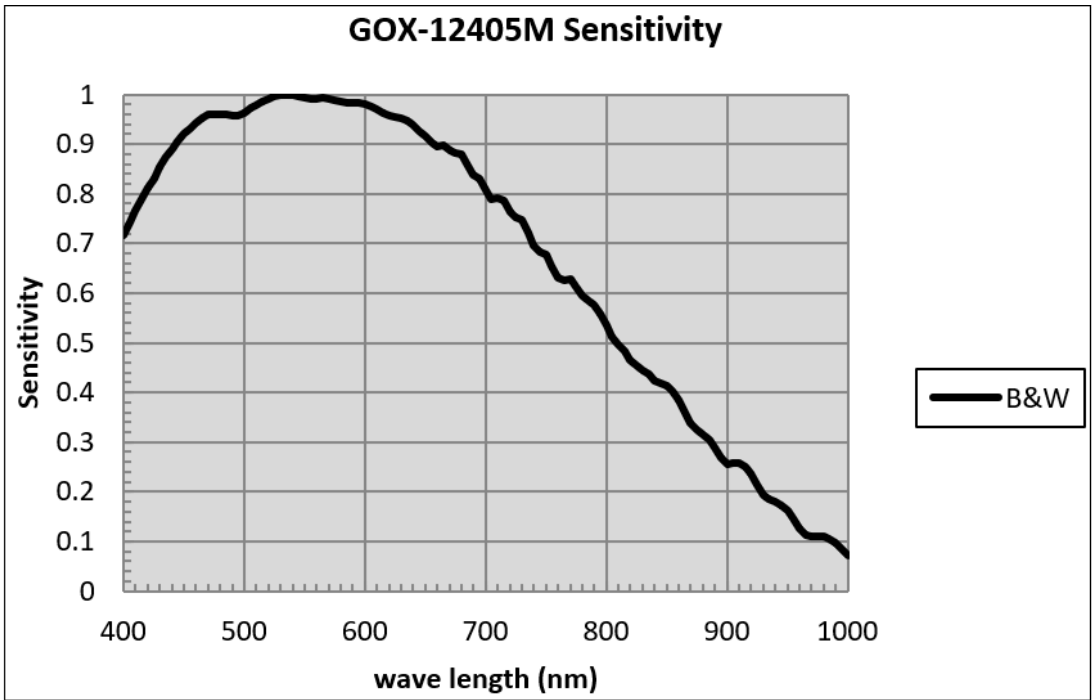

Spectral Response (GOX-16205M-PGE/GOX-16205C-PGE)

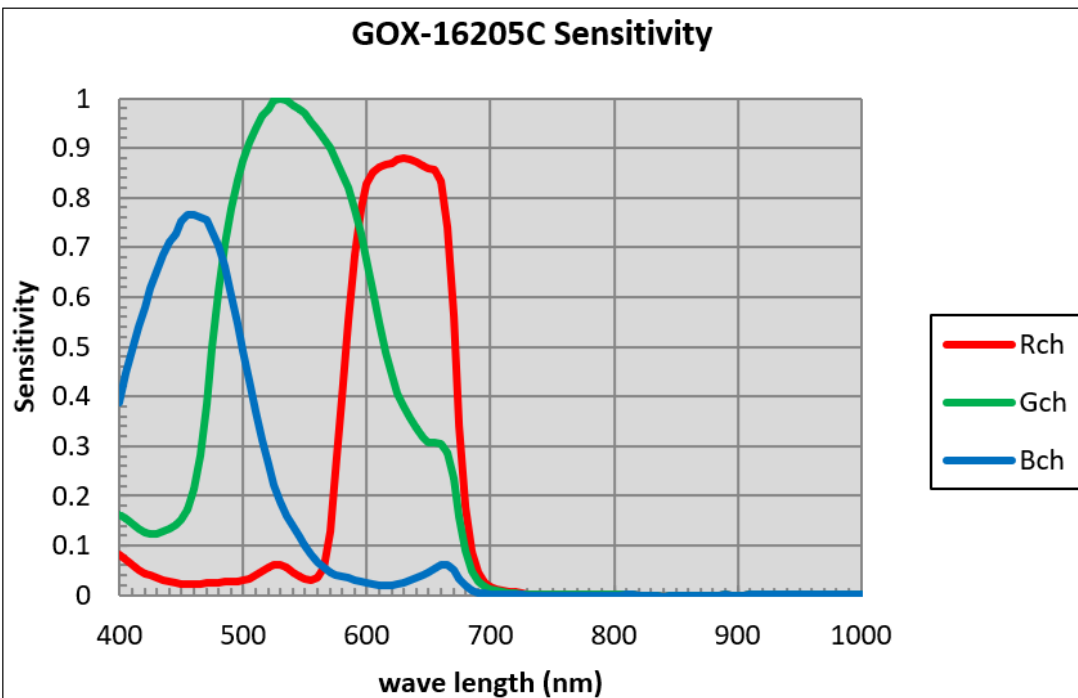
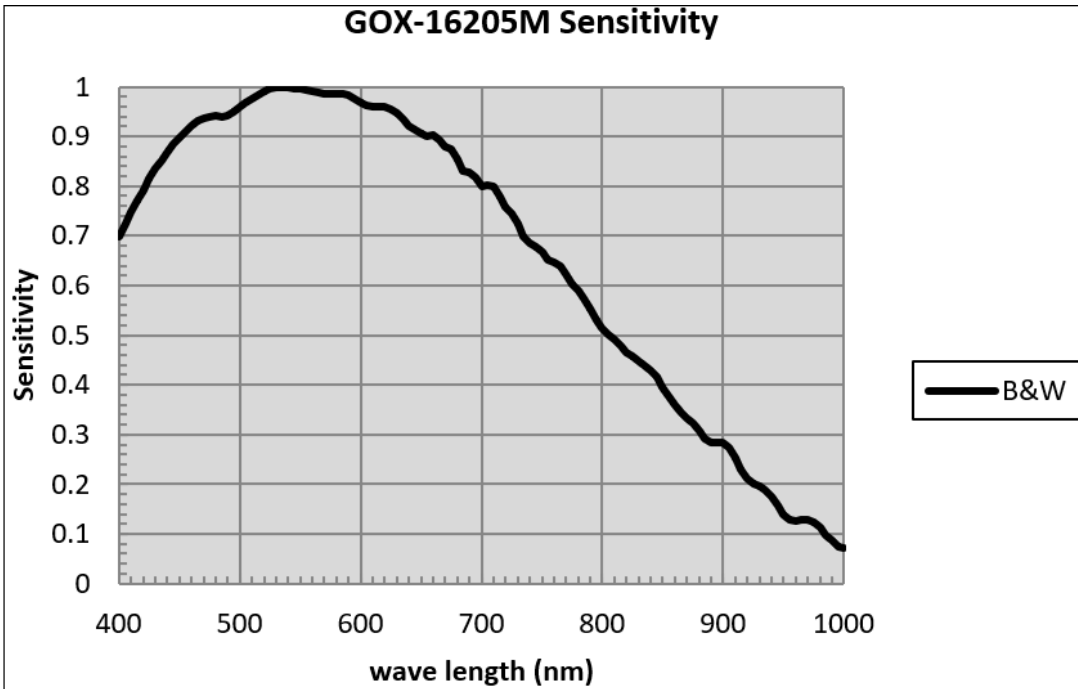

Spectral Response (GOX-20405M-PGE/GOX-20405C-PGE)

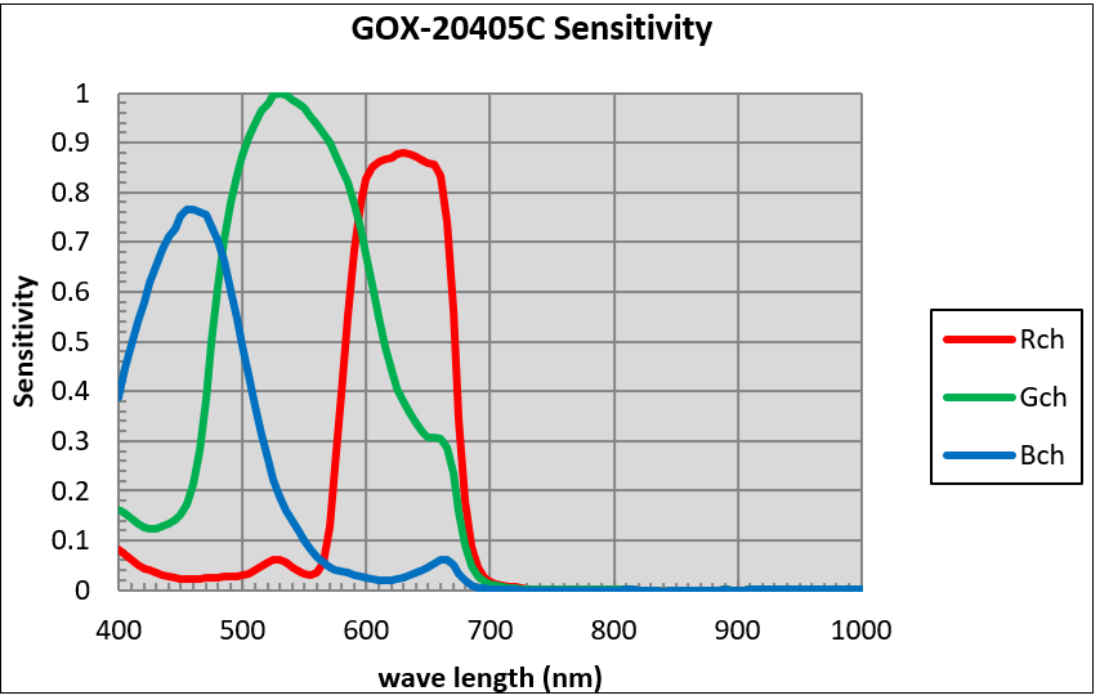
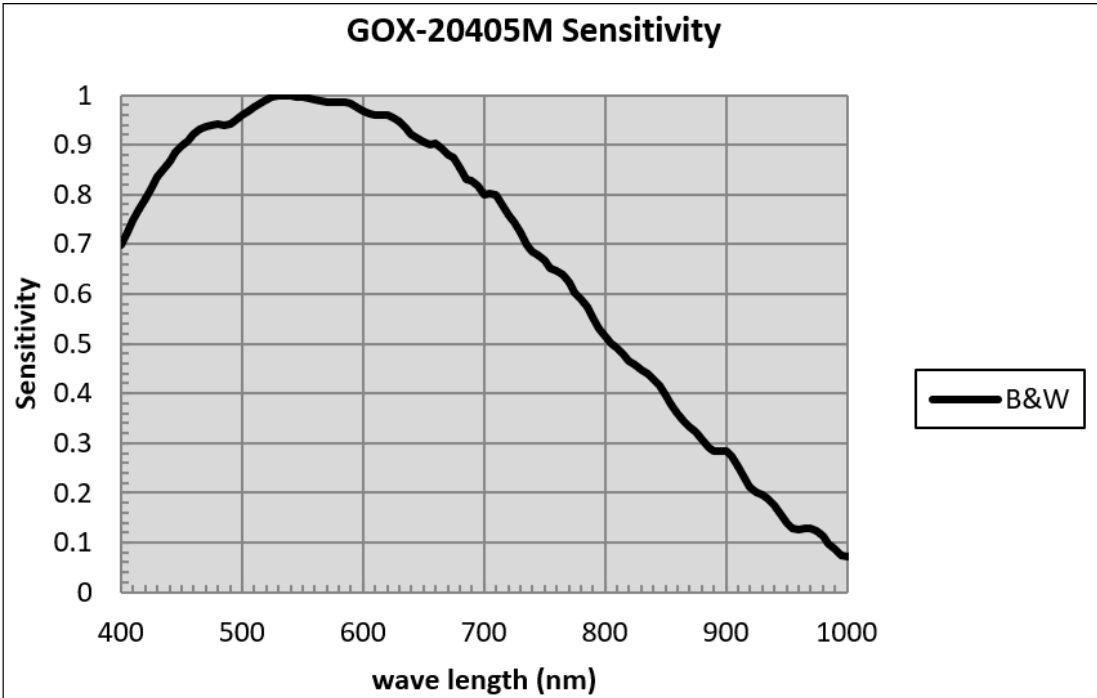

Spectral Response (GOX-24505M-PGE/GOX-24505C-PGE)

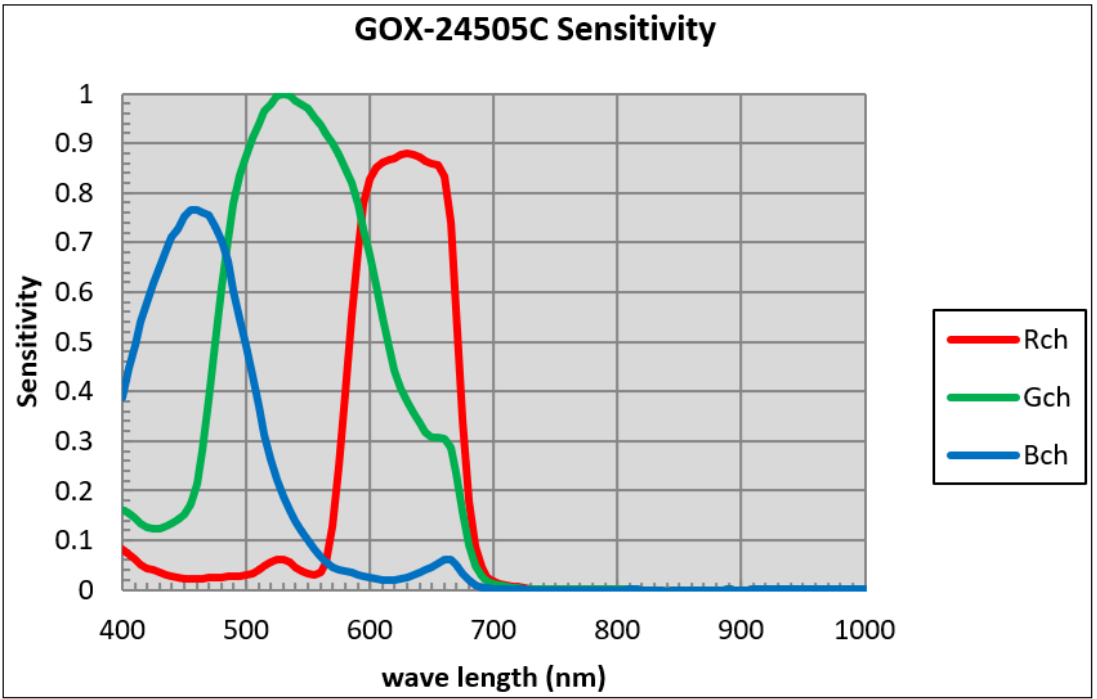
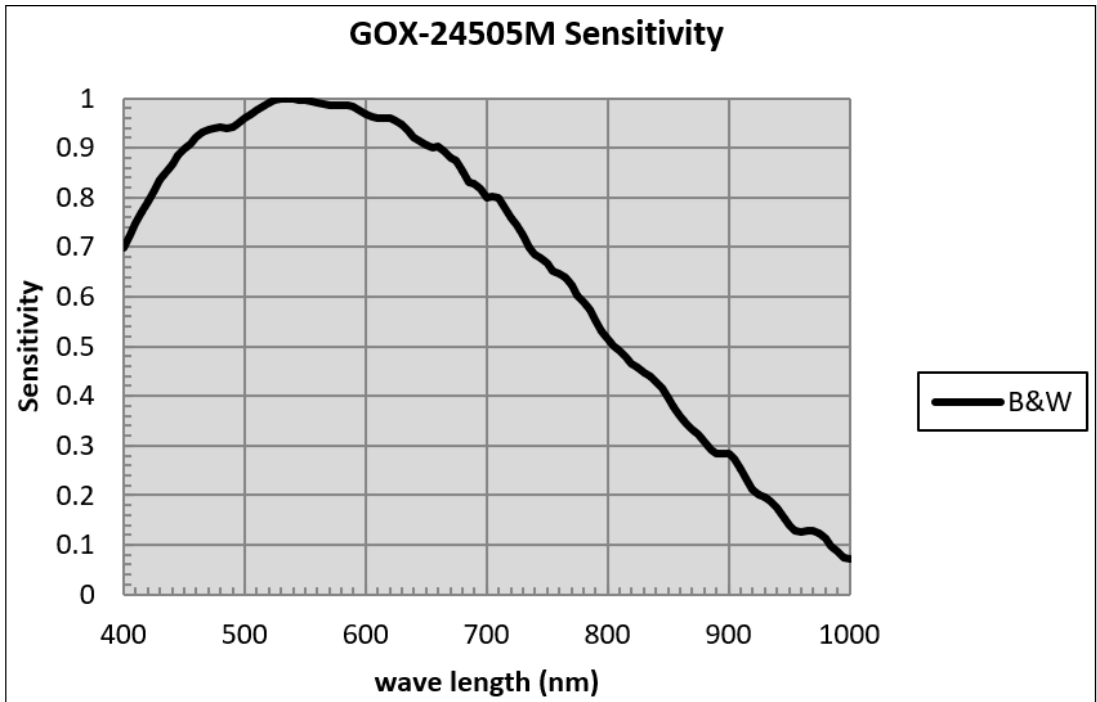

Dimensions

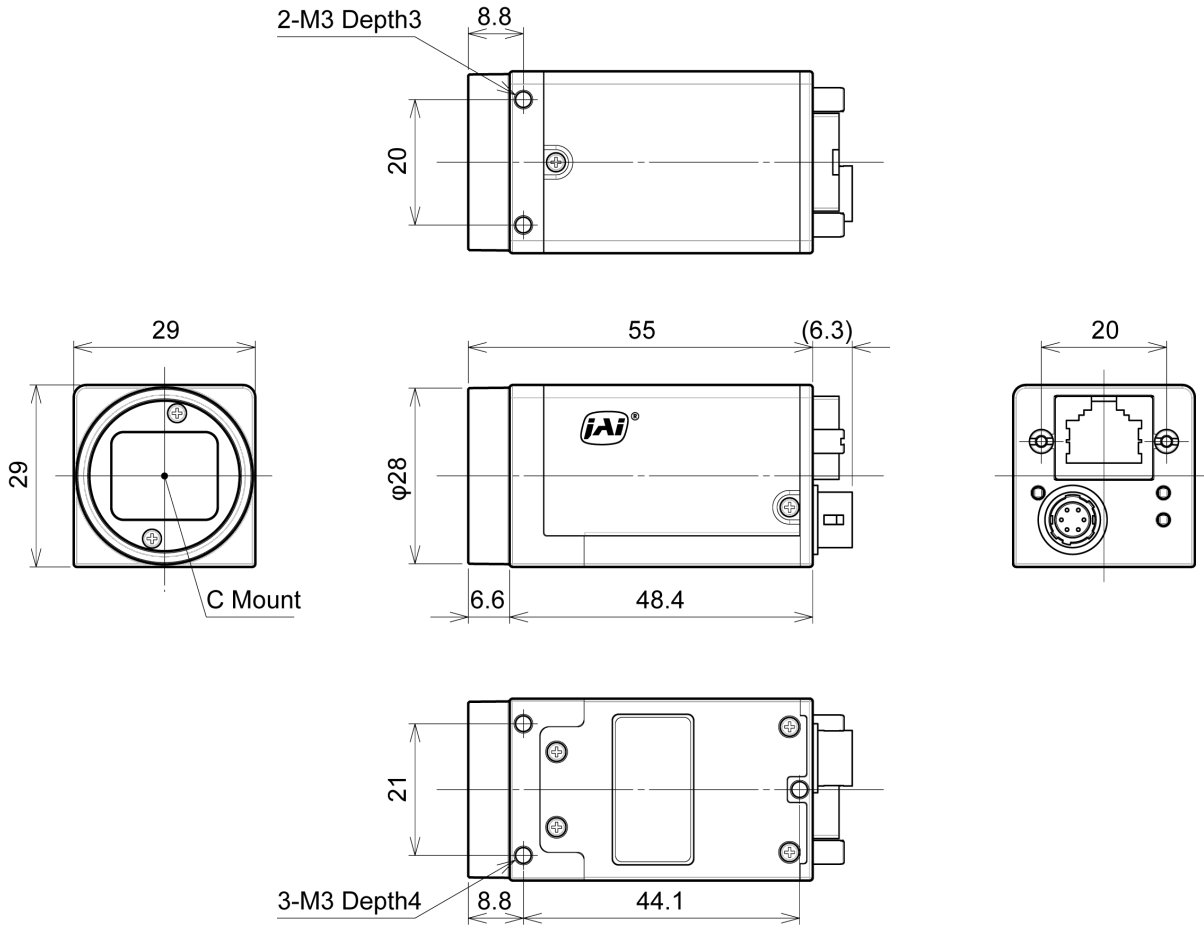

Notes:

- Dimensional tolerance: $\pm 0.3\text{mm}$
- Unit: mm

Comparison of the Decibel Display and Multiplier Display

Decibels [dB]	Multipliers [X]	Remarks
-6	0.501	
-5	0.562	
-4	0.631	
-3	0.708	
-2	0.794	
-1	0.891	
0	1	
1	1.122	
2	1.259	
3	1.413	
4	1.585	
5	1.778	
6	1.995	
7	2.239	
8	2.512	
9	2.818	
10	3.162	
11	3.548	
12	3.981	
13	4.467	
14	5.012	
15	5.623	
16	6.31	
17	7.079	
18	7.943	
19	8.913	
20	10	
21	11.22	
22	12.589	
23	14.125	
24	15.849	
25	17.783	
26	19.953	
27	22.387	
28	25.119	
29	28.184	
30	31.623	
31	35.481	

Decibels [dB]	Multipliers [X]	Remarks
32	39.811	
33	44.668	
34	50.119	
35	56.234	
36	63.096	
37	70.795	
38	79.433	
39	89.125	
40	100	
41	112.202	
42	125.893	

User's Record

Camera type: Go-X Series Global Shutter GigE interface

Model name:

Revision:

Serial No:

Firmware version:

For camera revision history, please contact your local JAI distributor.

Revision History

Revision	Date	Device Version	Changes
1.3	2024/03/21	DV0106	Updated " How to Use Decompression Library ".
1.2	2024/02/19	DV0106	Updated " Functions That Cannot Be Used Together " (" ROI Function (Single ROI) " and " Decimation Mode " cannot be used together). Updated the LAN Cable and China RoHS topics. Reworded the Caution on Package Contents .
1.1	2023/05/11	DV0103	New Functions: Image Compression Mode (Xpress) and ROI Centered . Now supports the RGB8 , RGB10V1Packed , and RGB10p32 Pixel Formats . Due to this change, added the Color Enhancer (Edge Enhancer, Color Enhancer) and Color Space Conversion (ColorTransformationControl) topics, and updated the Calculate the Maximum Frame or Trigger Rate (Approximate) , Timing Chart and Specifications topics. Updated the Timing Chart and Specifications topics as GevSCPSPacketSize (TransportLayerControl) is now expanded to 12036. Updated Image Scaling Mode (Xscale) . The minimum Width value when BinningHorizontal is set to 2 is now 48 (ROI Function (Single ROI)). Added the Scheduled Action Command function (Action Control Function). Added GevMCTT and GevMCRC to TransportLayerControl . Corrected the Note on FrameStart (Trigger Control) . Added LineSource to the table in the GPIO (Digital Input/Output Settings) topic. Decimation Mode : Added a note indicating that the parameters cannot be set individually. Added the Vertical Stripes issue to Phenomena Specific to CMOS Image Sensors .
1.0	2022/09/20	DV0100	First Release

Trademarks

Systems and product names described in this document are trademarks or registered trademarks of their respective owners. The ™ and ® symbols are not used in this document.

Europe, Middle East & Africa

Phone +45 4457 8888
Fax +45 4491 8880

Asia Pacific

Phone +81 45 440 0154
Fax +81 45 440 0166

Americas

Phone (Toll-Free) 1 800 445 5444
Phone +1 408 383 0300

Visit our website on www.jai.com



See the possibilities