



See the possibilities

# User Manual

*GOX Series - GigE Vision Interface*

**GOX-5105M-5GE**  
**GOX-5105C-5GE**  
**GOX-8105M-5GE**  
**GOX-8105C-5GE**  
**GOX-12405M-5GE**  
**GOX-12405C-5GE**  
**GOX-16205M-5GE**  
**GOX-16205C-5GE**  
**GOX-20405M-5GE**  
**GOX-20405C-5GE**  
**GOX-24505M-5GE**  
**GOX-24505C-5GE**



**CMOS Digital Progressive Scan Monochrome and Color Camera**

**Document Version: 1.3**

**Date: 2024-05-17**

Thank you for purchasing this product.

 Be sure to read this documentation before use.

This documentation includes important safety precautions and instructions on how to operate the unit. Be sure to read this documentation to ensure proper operation.

The contents of this documentation are subject to change without notice for the purpose of improvement.

# Table of Contents

<b>Table of Contents</b> .....	<b>2</b>
About Technical Note .....	8
<b>Notice/Warranty/Certifications</b> .....	<b>9</b>
Notice .....	9
Warranty .....	9
Certifications .....	9
CE Compliance .....	9
FCC .....	9
Warning .....	10
KC .....	10
China RoHS .....	11
<b>Package Contents, Accessories</b> .....	<b>12</b>
<b>Usage Precautions</b> .....	<b>13</b>
Notes When the Camera's Internal Temperature Rises .....	13
Notes on Supplying Power via PoE .....	13
Maximum Allowable Temperature .....	14
Notes on Cable Configurations .....	15
Notes on Attaching the Lens .....	15
Notes on LAN Cable Connection .....	15
Phenomena Specific to CMOS Image Sensors .....	16
Notes on Exportation .....	16
<b>Features</b> .....	<b>17</b>
Feature Overview .....	17
<b>Parts Identification</b> .....	<b>19</b>
① Lens Mount (C-Mount) .....	19
② RJ-45 Connector .....	20
③ LINK LED .....	20
④ ACT LED .....	20
⑤ POWER/TRIG LED .....	21
⑥ DC IN/TRIG Connector (6-Pin Round) .....	21

⑦ ⑧ Mounting Holes .....	22
Recommended Circuit Diagram (Reference Examples) .....	22
Recommended External Input Circuit Diagram .....	22
Recommended External Output Circuit Diagram .....	22
Characteristics of the Recommended Circuits for Opto OUT .....	23
<b>Preparation .....</b>	<b>24</b>
Step 1: Install the Software (First Time Only) .....	25
Step 2: Connect Devices .....	25
① Lens .....	26
② JAI HS-02 Heatsink Set (When Supplying Power via PoE) .....	27
How to Attach/Mount .....	27
③ Mounting (or Use MP-46 Tripod Adapter Plate) .....	28
④ LAN Cable .....	28
⑤ Network Card .....	29
⑥ DC IN / Trigger IN Connection Cable .....	29
⑦ AC Adapter (Power Supply) (If Necessary) .....	29
Step 3: Verify Camera Operation .....	30
Step 4: Verify the Connection between the Camera and PC .....	31
Step 5: Change the Camera Settings .....	33
Step 6: Adjust the Image Quality .....	34
Adjust the Gain .....	35
Adjust the White Balance .....	36
Adjust the Black Level .....	37
Step 7: Save the Settings .....	38
To Save User Settings .....	39
To Load User Settings .....	40
<b>Main Functions .....</b>	<b>41</b>
Acquisition Control .....	41
Changing the Frame Rate .....	42
Exposure Mode .....	43
Actual Exposure Time .....	44
RCT Mode .....	44

Trigger Control .....	45
When Using the FrameStart Trigger .....	47
Pixel Format .....	48
Image Flip Function .....	49
SensorDigitizationBits .....	50
GPIO (Digital Input/Output Settings) .....	51
VideoProcessBypassMode .....	52
Calculate the Maximum Frame or Trigger Rate (Approximate) .....	53
1. Calculate the H Period .....	53
2. Calculate the Minimum Frame Period .....	56
3. Calculate the Maximum Frame Rate or Maximum Trigger Rate .....	57
Timing Chart .....	59
Exposure Mode = Timed (Overlap Readout) .....	60
GOX-5105M-5GE, GOX-5105C-5GE .....	61
GOX-8105M-5GE, GOX-8105C-5GE .....	62
GOX-12405M-5GE, GOX-12405C-5GE .....	63
GOX-16205M-5GE, GOX-16205C-5GE .....	64
GOX-20405M-5GE, GOX-20405C-5GE .....	65
GOX-24505M-5GE, GOX-24505C-5GE .....	66
Exposure Mode = TriggerWidth (Overlap Readout) .....	67
GOX-5105M-5GE, GOX-5105C-5GE .....	68
GOX-8105M-5GE, GOX-8105C-5GE .....	69
GOX-12405M-5GE, GOX-12405C-5GE .....	70
GOX-16205M-5GE, GOX-16205C-5GE .....	71
GOX-20405M-5GE, GOX-20405C-5GE .....	72
GOX-24505M-5GE, GOX-24505C-5GE .....	73
Exposure Mode = Timed (RCT Mode) .....	74
GOX-5105M-5GE, GOX-5105C-5GE .....	75
GOX-8105M-5GE, GOX-8105C-5GE .....	76
GOX-12405M-5GE, GOX-12405C-5GE .....	77
GOX-16205M-5GE, GOX-16205C-5GE .....	78
GOX-20405M-5GE, GOX-20405C-5GE .....	79

GOX-24505M-5GE, GOX-24505C-5GE .....	80
Gain Control .....	81
Automatic Gain Level Control .....	81
White Balance .....	82
Color Temperature .....	82
ALC (Automatic Level Control) Function .....	83
To Use the ALC Function .....	83
Gamma Function .....	84
To Use the Gamma Function .....	84
LUT (Lookup Table) .....	85
To Use the LUT Function .....	85
LUT Value .....	85
BlemishCompensation .....	86
Automatic Detection .....	86
Manual Configuration .....	87
Shading Correction .....	88
To Use the Shading Correction Function .....	89
Binning Function .....	90
Image Scaling Mode (Xscale) .....	91
Specifying the Scaling Ratio .....	92
Decimation Mode .....	94
Gradation Compression Mode .....	95
Examples .....	96
Overlay Mode .....	98
ROI Function (Single ROI) .....	99
Single ROI - Example .....	100
ROI Centered .....	101
ROI Function (Multi ROI) .....	102
Configuration Example .....	104
Color Space Conversion (ColorTransformationControl) .....	105
Edge Enhancer, Color Enhancer .....	106
Sequencer Function .....	107

TriggerSequencer Mode .....	107
Sample TriggerSequencer Mode Operation .....	108
CommandSequencer Mode .....	109
Pulse Generator .....	110
Counter and Timer Control Function .....	111
Counter Occurrence Diagram .....	111
Internal Camera Blocks .....	112
To Use the Counter Function .....	112
Action Control Function .....	113
Action Control Example .....	114
Chunk Data Function .....	114
Event Control Function .....	115
PTP (Precision Time Protocol) .....	116
Temperature Warning Mode .....	117
Functions That Cannot Be Used Together .....	120
<b>Setting List (Feature Properties) .....</b>	<b>121</b>
Selector .....	121
DeviceControl .....	122
TransportLayerControl .....	124
ImageFormatControl .....	129
MultiROIControl .....	136
AcquisitionControl .....	138
DigitalIIOControl .....	141
PulseGenerator .....	143
AnalogControl .....	146
LUTControl .....	148
AutoLevelControl .....	149
ColorTransformationControl .....	151
ImagingControl .....	152
ShadingControl .....	153
BlemishControl .....	154
SequencerControl .....	155

CounterAndTimerControl .....	158
ActionControl .....	159
EventControl .....	160
ChunkDataControl .....	161
TestControl .....	163
UserSetControl .....	163
<b>Miscellaneous .....</b>	<b>164</b>
Troubleshooting .....	164
Power Supply and Connections .....	164
Image Display .....	164
Settings and Operations .....	164
Specifications .....	165
Spectral Response (GOX-5105M-5GE/GOX-5105C-5GE) .....	173
Spectral Response (GOX-8105M-5GE/GOX-8105C-5GE) .....	174
Spectral Response (GOX-12405M-5GE/GOX-12405C-5GE) .....	175
Spectral Response (GOX-16205M-5GE/GOX-16205C-5GE) .....	176
Spectral Response (GOX-20405M-5GE/GOX-20405C-5GE) .....	177
Spectral Response (GOX-24505M-5GE/GOX-24505C-5GE) .....	178
Dimensions .....	179
Camera .....	179
JAI HS-02 Heatsink Set .....	180
JAI HS-02 Heatsink Set with the Camera .....	181
Comparison of the Decibel Display and Multiplier Display .....	182
User's Record .....	183
<b>Appendix .....</b>	<b>184</b>
<b>Revision History .....</b>	<b>185</b>

## About Technical Note

---



Some additional technical information is provided on the JAI website as Technical Notes. In this manual, if a technical note is available for a particular topic, the above icon is shown. Please refer to the following URL for Technical notes.

<https://www.jai.com/support-software/technical-notes>



# Notice/Warranty/Certifications

## Notice

---

The material contained in this manual consists of information that is proprietary to JAI Ltd., Japan, and may only be used by the purchasers of the product. JAI Ltd., Japan makes no warranty for the use of its product and assumes no responsibility for any errors which may appear or for damages resulting from the use of the information contained herein. JAI Ltd., Japan reserves the right to make changes without notice.

Company and product names mentioned in this manual are trademarks or registered trademarks of their respective owners.

## Warranty

---

For information about the warranty, please contact your factory representative.

## Certifications

---

### CE Compliance

---

As defined by the Directive 2004/108/EC of the European Parliament and of the Council, EMC (Electromagnetic compatibility), JAI Ltd., Japan declares that GOX-5105M-5GE, GOX-5105C-5GE, GOX-8105M-5GE, GOX-8105C-5GE, GOX-12405M-5GE, GOX-12405C-5GE, GOX-16205M-5GE, GOX-16205C-5GE, GOX-20405M-5GE, GOX-20405C-5GE, GOX-24505M-5GE, and GOX-24505C-5GE comply with the following provisions applying to their standards.

EN 55032:2015(CISPR32:2015)

EN 55035:2017(CISPR35:2016)

### FCC

---

This equipment has been tested and found to comply with the limits for a Class A digital device, pursuant to Part 15 of the FCC Rules. These limits are designed to provide reasonable protection against harmful interference in a residential installation. This equipment generates, uses, and can radiate radio frequency energy and, if not installed and used in accordance with the instructions, may cause harmful interference to radio communications. However, there is no guarantee that interference will not occur in a particular installation. If this equipment does cause harmful interference to radio or television reception, which can be determined by turning the equipment off and on, the user is encouraged to try to correct the interference by one or more of the following measures:

- Reorient or relocate the receiving antenna.
- Increase the separation between the equipment and receiver.

- Connect the equipment into an outlet on a circuit different from that to which the receiver is connected.
- Consult the dealer or an experienced radio/TV technician for help.

## Warning

Changes or modifications to this unit not expressly approved by the party responsible for FCC compliance could void the user's authority to operate the equipment.

## KC



상 호: JAI Ltd.,Japan  
 기자재명칭: Industrial camera  
 모 델 명: GOX-5105M-5GE  
 제조사 및 제조국가: JAI Ltd.,Japan / JAPAN  
 R-R-JAI-GOX-24505M-5GE



상 호: JAI Ltd.,Japan  
 기자재명칭: Industrial camera  
 모 델 명: GOX-5105C-5GE  
 제조사 및 제조국가: JAI Ltd.,Japan / JAPAN  
 R-R-JAI-GOX-24505M-5GE



상 호: JAI Ltd.,Japan  
 기자재명칭: Industrial camera  
 모 델 명: GOX-8105M-5GE  
 제조사 및 제조국가: JAI Ltd.,Japan / JAPAN  
 R-R-JAI-GOX-24505M-5GE



상 호: JAI Ltd.,Japan  
 기자재명칭: Industrial camera  
 모 델 명: GOX-8105C-5GE  
 제조사 및 제조국가: JAI Ltd.,Japan / JAPAN  
 R-R-JAI-GOX-24505M-5GE



상 호: JAI Ltd.,Japan  
 기자재명칭: Industrial camera  
 모 델 명: GOX-12405M-5GE  
 제조사 및 제조국가: JAI Ltd.,Japan / JAPAN  
 R-R-JAI-GOX-24505M-5GE



상 호: JAI Ltd.,Japan  
 기자재명칭: Industrial camera  
 모 델 명: GOX-12405C-5GE  
 제조사 및 제조국가: JAI Ltd.,Japan / JAPAN  
 R-R-JAI-GOX-24505M-5GE



상 호: JAI Ltd.,Japan  
 기자재명칭: Industrial camera  
 모 델 명: GOX-16205M-5GE  
 제조사 및 제조국가: JAI Ltd.,Japan / JAPAN  
 R-R-JAI-GOX-24505M-5GE



상 호: JAI Ltd.,Japan  
 기자재명칭: Industrial camera  
 모 델 명: GOX-16205C-5GE  
 제조사 및 제조국가: JAI Ltd.,Japan / JAPAN  
 R-R-JAI-GOX-24505M-5GE



상 호: JAI Ltd.,Japan  
 기자재명칭: Industrial camera  
 모 델 명: GOX-20405M-5GE  
 제조사 및 제조국가: JAI Ltd.,Japan / JAPAN  
 R-R-JAI-GOX-24505M-5GE



상 호: JAI Ltd.,Japan  
 기자재명칭: Industrial camera  
 모 델 명: GOX-20405C-5GE  
 제조사 및 제조국가: JAI Ltd.,Japan / JAPAN  
 R-R-JAI-GOX-24505M-5GE



상 호: JAI Ltd.,Japan  
 기자재명칭: Industrial camera  
 모 델 명: GOX-24505M-5GE  
 제조사 및 제조국가: JAI Ltd.,Japan / JAPAN  
 R-R-JAI-GOX-24505M-5GE



상 호: JAI Ltd.,Japan  
 기자재명칭: Industrial camera  
 모 델 명: GOX-24505C-5GE  
 제조사 및 제조국가: JAI Ltd.,Japan / JAPAN  
 R-R-JAI-GOX-24505M-5GE

제조년월은 제품상자의 라벨을 참조하십시오.

## China RoHS

The following statement is related to the regulation on “Measures for the Administration of the Control of Pollution by Electronic Information Products”, known as “China RoHS”. The table shows contained Hazardous Substances in this camera.

 mark shows that the environment-friendly use period of contained Hazardous Substances is 15 years.

### 重要注意事项

#### 有毒有害物质或元素名称及含量表

根据中华人民共和国信息产业部『电器电子产品有害物质限制使用管理办法』，本产品《有毒有害物质或元素名称及含量表》如下。

部件名称	有毒有害物质或元素					
	铅 (Pb)	汞 (Hg)	镉 (Cd)	六价铬 (Cr (VI))	多溴联苯 (PBB)	多溴二苯醚 (PBDE)
GOX-5105MC-5GE						
GOX-8105MC-5GE						
GOX-12405MC-5GE						
GOX-16205MC-5GE	×	○	○	○	○	○
GOX-20405MC-5GE						
GOX-24505MC-5GE						

○:表示该有毒有害物质在该部件所有均质材料中的含量均在 GB/T 26572-2011规定的限量要求以下。  
 ×:表示该有毒有害物质至少在该部件的某一均质材料中的含量超出 GB/T 26572-2011规定的限量要求。

#### 环保使用期限



电子信息产品中含有的有毒有害物质或元素在正常使用的条件下不会发生外泄或突变、电子信息产品用户使用该电子信息产品不会对环境造成严重污染 或对其人身、财产造成严重损害的期限。

数字「15」为期限15年。

## Package Contents, Accessories

	Camera (1)
	Sensor protection cap (1)
	Dear customer (sheet) (1)

### Optional Accessories (Sold Separately)

**Note:** The tripod adapter plate and the JAI HS-02 heatsink set cannot be used together. When using a tripod with the JAI HS-02 heatsink set attached to the camera, use the tripod screw hole on the bottom of the JAI HS-02 heatsink.

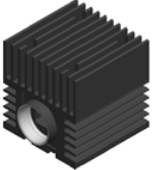
	MP-46 Tripod Adapter Plate
	<p>JAI HS-02 Heatsink Set</p> <p><b>Related Topic:</b> <a href="#">© JAI HS-02 Heatsink Set (When Supplying Power via PoE)</a></p>

## Usage Precautions

### Notes When the Camera's Internal Temperature Rises

This camera has the TemperatureWarningMode function ([DeviceControl](#)) enabled by default, which reduces the frame rate when the internal temperature of the camera rises significantly.

If the internal temperature continues to rise and reaches the [Maximum Allowable Temperature](#), the camera will become uncontrollable from the host side even if this function is disabled.

For more information, see [Temperature Warning Mode](#).

### Notes on Supplying Power via PoE

The use of the PoE function results in higher power consumption and more heat generation than when power is supplied via the 6-pin connector. Therefore, the PoE function should only be used if steps are taken to ensure that excess heat does not create a safety hazard or cause damage to the camera.

Specifically, PoE should only be used when one of the two following operating conditions is met:

- The camera is outfitted with the JAI Heatsink set (HS-02, sold separately).  
or
- The camera is operated with a limited LAN cable length and frame rate as specified below.

#### Cautions:

- The camera warranty does not cover the use of the PoE function unless one of the two specified operating conditions is met.
- Even under specified operating conditions, the camera housing and heatsink surface temperatures can reach 76°C at room temperature. Please take sufficient safety measures to guard against serious injuries (burns).

#### Operating Condition Option 1: Attach the JAI HS-02 Heatsink Set

When operating this camera using PoE, attach the JAI HS-02 heatsink set (sold separately) to the camera.

When the JAI HS-02 heatsink set is properly attached, there are no limitations on the LAN cable length and/or the frame rate.

#### Notes:

- For details on how to attach the JAI HS-02 heatsink set, see [② JAI HS-02 Heatsink Set \(When Supplying Power via PoE\)](#) in the Preparation chapter.
- Regarding the JAI HS-02 heatsink set's performance, see [Appendix](#).

## Operating Condition Option 2: Limit the LAN Cable Length and Frame Rate (without the JAI HS-02 Heatsink set)

When operating this camera using PoE without attaching the JAI HS-02 heatsink set, the following conditions must be strictly observed.

1. LAN Cable Length: Less than 10m
2. Frame Rate: Do not exceed the frame rate shown below (50% of the camera's maximum frame rate)

Camera Model	Recommended Max Frame Rate
GOX-5105MC-5GE	51 fps
GOX-8105MC-5GE	33 fps
GOX-12405MC-5GE	21 fps
GOX-16205MC-5GE	16 fps
GOX-20405MC-5GE	13 fps
GOX-24505MC-5GE	11 fps

**Note:** JAI performs the temperature evaluations in the following test environments with or without outfitted by the JAI HS-02 heatsink set.

- Environment: 25°C (in a thermostatic chamber)
- On an aluminum plate (195 x 195 x 10mm)

## Maximum Allowable Temperature

If operating the camera for a long period of time, make sure that the camera's internal temperature will not exceed the following maximum temperature.

Measurement Area	Maximum Allowable Temperature
FPGA	95°C
Sensor	100°C
PHY	100°C

**Notes:**

- You can monitor the camera's internal temperature by DeviceTemperature ([DeviceControl](#)).
- This camera has a function that monitors the internal temperature of the camera and automatically lowers the frame rate to reduce the heat generated by the camera. For more information, see [Temperature Warning Mode](#).

## Notes on Cable Configurations

---

The presence of lighting equipment and television receivers nearby may result in video noise. In such cases, change the cable configurations or placement.

## Notes on Attaching the Lens

---

**Technical Notes****How to Clean a Sensor**

### Avoiding Dust Particles

When attaching the lens to the camera, stray dust and other particles may adhere to the sensor surface and rear surface of the lens. Be careful of the following when attaching the lens.

- Work in a clean environment.
- Do not remove the caps from the camera and lens until immediately before you attach the lens.
- To prevent dust from adhering to surfaces, point the camera and lens downward and do not allow the lens surface to come into contact with your hands or other objects.
- Always use a blower brush to remove any dust that adheres.
- Never use your hands or cloth, blow with your mouth, or use other methods to remove dust.

## Notes on LAN Cable Connection

---

Secure the locking screws on the connector manually, and do not use a driver. Do not secure the screws too tightly. Doing so may wear down the screw threads on the camera. (Tightening torque: 0.147 Nm or less)

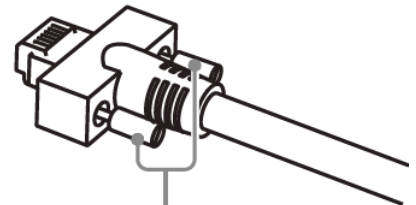

**Caution:** Secure manually. Do not secure too tightly.

## Phenomena Specific to CMOS Image Sensors

---

The following phenomena are known to occur on cameras equipped with CMOS image sensors. These do not indicate malfunctions.

- **Aliasing:** When shooting straight lines, stripes, and similar patterns, vertical aliasing (zigzag distortion) may appear on the monitor.
- **Blooming:** When strong light enters the camera, some pixels on the CMOS image sensor may receive much more light than they are designed to hold, causing the accumulated signal charge to overflow into surrounding pixels. This “blooming” phenomenon can be seen in the image but does not affect the operation of the camera.
- **Fixed pattern noise:** When shooting dark objects in high-temperature conditions, fixed pattern noise may occur throughout the entire video monitor screen.
- **Defective pixels:** Defective pixels (white and black pixels) of the CMOS image sensor are minimized at the factory according to shipping standards. However, as this phenomenon can be affected by the ambient temperature, camera settings (e.g., high sensitivity and long exposure), and other factors, be sure to operate within the camera’s specified operating environment.
- **Vertical stripes:** Due to the design characteristics of the sensor used, vertical stripes may appear in the image when using the camera under the following condition(s), especially a combination of these circumstances:
  - A shallow incident angle, a large aperture, a short exposure time, and/or the use of long-waveband lighting (especially infrared)

You may be able to improve the vertical stripes in the image by changing the above condition(s) (e.g., smaller aperture, longer shutter speed).

## Notes on Exportation

---

When exporting this product, please follow the export regulations of your country or region.



## Features

These camera models are industrial progressive scan cameras equipped with a global shutter CMOS image sensor. These small-size cameras (approx. 29mm x 29mm x 68mm) are also lightweight (95g), which makes them easy to install and mount. In addition, these provide an attractive combination of high resolution, high speed, and high image quality for machine vision applications.

Model Name	Image Sensor		Active Pixels	Pixel Size	Max Frame Rate* (6-pin Power Supply)
GOX-5105M-5GE	Mono	Type 1/1.8	2472 x 2064	2.74 μm x 2.74 μm	112 fps
GOX-5105C-5GE	Color				
GOX-8105M-5GE	Mono	Type 2/3	2856 x 2848	2.74 μm x 2.74 μm	71 fps
GOX-8105C-5GE	Color				
GOX-12405M-5GE	Mono	Type 1/1.1	4128 x 3008	2.74 μm x 2.74 μm	47 fps
GOX-12405C-5GE	Color				
GOX-16205M-5GE	Mono	Type 1.1	5328 x 3040	2.74 μm x 2.74 μm	36 fps
GOX-16205C-5GE	Color				
GOX-20405M-5GE	Mono	Type 1.1	4512 x 4512	2.74 μm x 2.74 μm	29 fps
GOX-20405C-5GE	Color				
GOX-24505M-5GE	Mono	Type 1.2	5328 x 4608	2.74 μm x 2.74 μm	24 fps
GOX-24505C-5GE	Color				

\*When Pixel Format = **Mono8/BayerRG8**, SensorDigitizationBits = **10 Bits**, NetworkThroughputSafetyMargin = **100**, Packet Size = **12036**, ExtendedIDMode = **Off**.

**Caution:** Refer to [Notes on Supplying Power via PoE](#) for the frame rate limitation when supplying power via PoE.

## Feature Overview

- Global shutter CMOS image sensor with backside illuminated pixel technology
- 8/10/12-bit output in choice of monochrome or raw Bayer color models
- Flexible ROI; rescaling function (monochrome and color); traditional 1x2, 2x1, 2x2 binning (monochrome models); horizontal/vertical image flip function; blemish correction; shading compensation; sequencer function; and Automatic Level Control (ALC). (See the [Main Functions](#) chapter for details).

- Compact size with excellent shock and vibration resistance
- PoE or via separate 6-pin connector

**Caution:** See [Notes on Supplying Power via PoE](#) when the camera is operating with a PoE power supply.

- Lens mount: C-mount

## Parts Identification

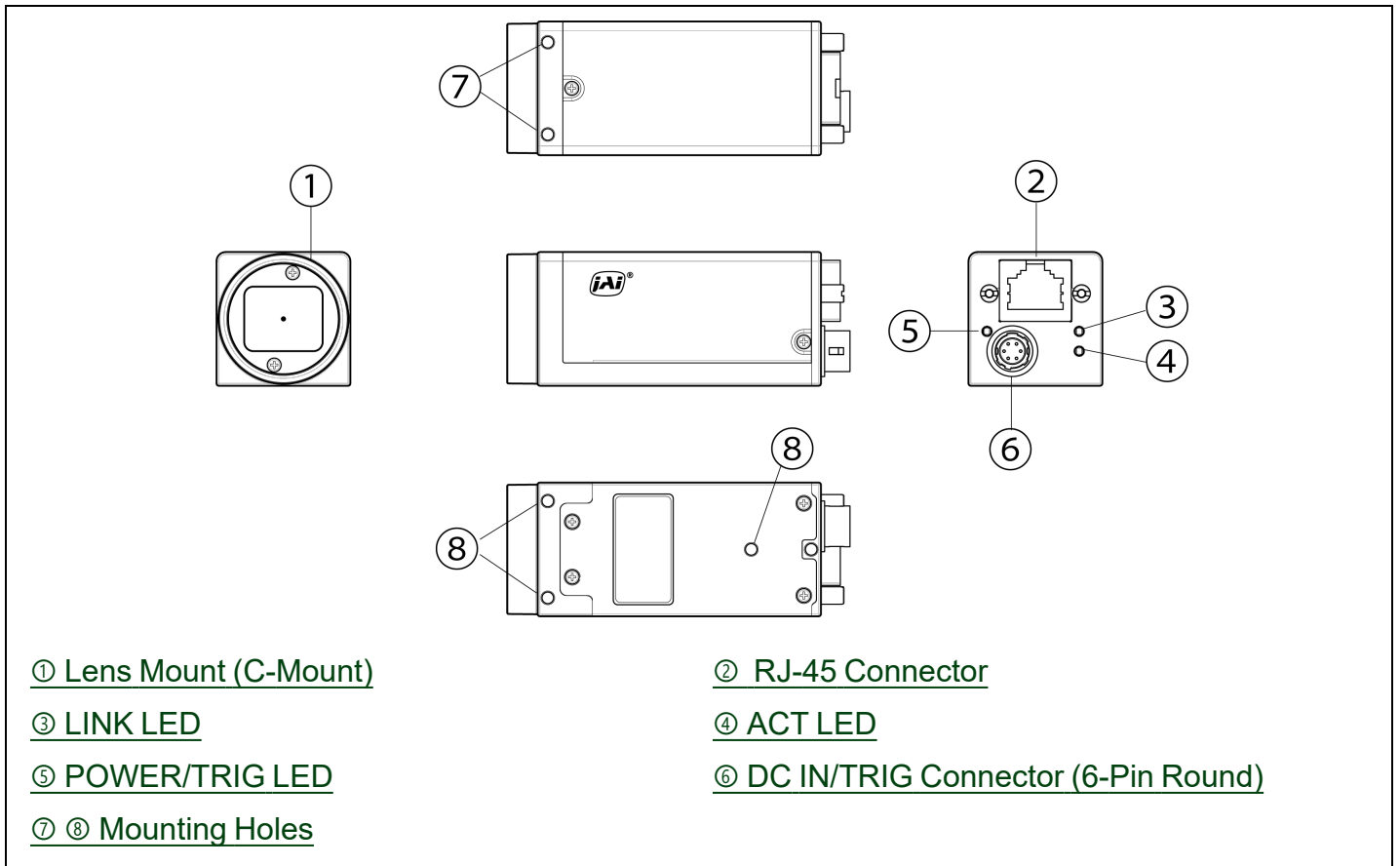

### ① Lens Mount (C-Mount)

Mount a C-mount lens, microscope adapter, etc. here.

**Note:** Before mounting a lens, be sure to refer to [① Lens](#) and confirm the precautions for attaching a lens and the supported lens types.



## ② RJ-45 Connector

Connect a Gigabit Ethernet compatible LAN cable (Category 5e or higher, Category 6 recommended) here.

 <p><b>RJ45 with Locking Screws</b></p>	<b>GigE Vision Interface</b>	
	Pin	Signal
	1	TRD+ (0)
	2	TRD- (0)
	3	TRD+ (1)
	4	TRD+ (2)
	5	TRD- (2)
	6	TRD- (1)
	7	TRD+ (3)
8	TRD- (3)	



## ③ LINK LED

Indicates whether the GigE network connection is established or not.

LED		Status
	Off	The network link is not established (or in progress).
	Blinking green (slow)	1000BASE-T link is established. (Interval 1sec)
	Blinking green (quick)	2.5GBASE-T or 5GBASE-T link is established. (Interval 200ms)



## ④ ACT LED

Indicates the GigE network status.

LED		Status
	Off	Communication is not active.
	Blinking amber	Communication is active.

## ⑤ POWER/TRIG LED

Indicates the power or trigger input status.

LED		Status
	Lit amber	Camera initializing
	Lit green	Camera in operation
	Blinking green	During operation in trigger mode, trigger signals are being input. <b>Note:</b> The blinking interval is not related to the actual input interval of the external trigger.

## ⑥ DC IN/TRIG Connector (6-Pin Round)

Connect the cable for a power supply (optional) or for DC IN / trigger IN here.

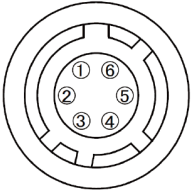
	Camera Side: HR10A-7R-6PB (Hirose Electric or equivalent )			
	Cable Side: : HR10A-7P-6S (Plug) (Hirose Electric or equivalent )			
	Pin No.	Input/Output	Signal	Description
	1	Power In	DC In	DC in +10V ~ +25V
	2	In	Opto In+	Line 5
	3	In	Opto In-	
	4	Out	Opto Out+	Line 2
	5	Out	Opto Out-	
6	GND	GND		

### Notes:

- See [Recommended Circuit Diagram \(Reference Examples\)](#) for the recommended Input/Output circuit diagrams.
- Refer to the [GPIO \(Digital Input/Output Settings\)](#) topic as well.

## ⑦ ⑧ Mounting Holes

Use these holes when mounting the camera directly to a wall or other structural system.

- ⑦ Upper part of camera: M3, 3mm depth, 20mm pitch
- ⑧ Lower part of camera: M3, 4mm depth, 21mm pitch (lens side)

## Recommended Circuit Diagram (Reference Examples)

Related Setting Items: [DigitalIOControl](#)

### Technical Notes OPTO-In Circuit Characteristics

**Note:** The OptInFilter function ([DeviceControl](#)) can eliminate the chattering that occurs when switching between the Low and High OptoIn signals up to 40ms.

## Recommended External Input Circuit Diagram

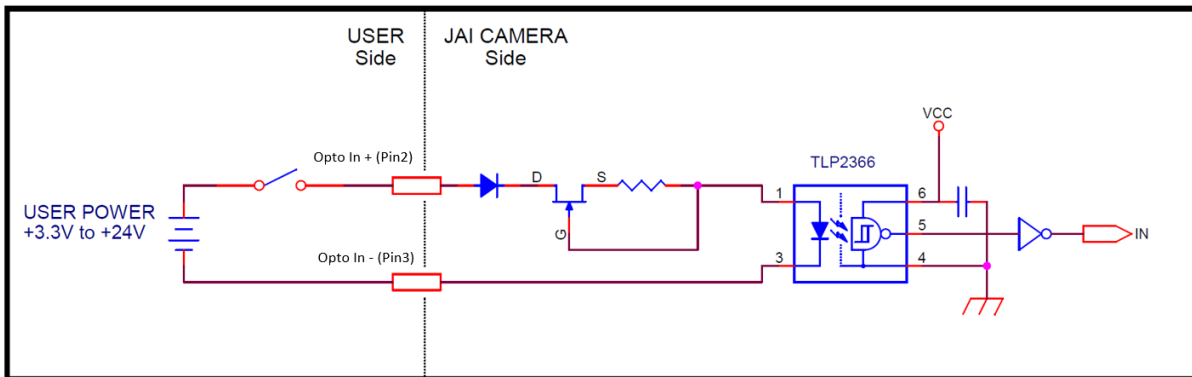

## Recommended External Output Circuit Diagram

### Reference Example

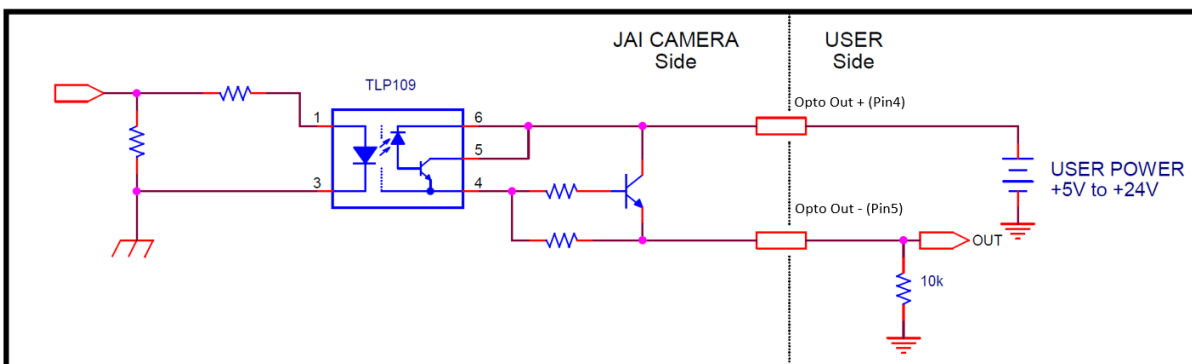

## Characteristics of the Recommended Circuits for Opto OUT

### OUTPUT LINE RESPONSE TIME

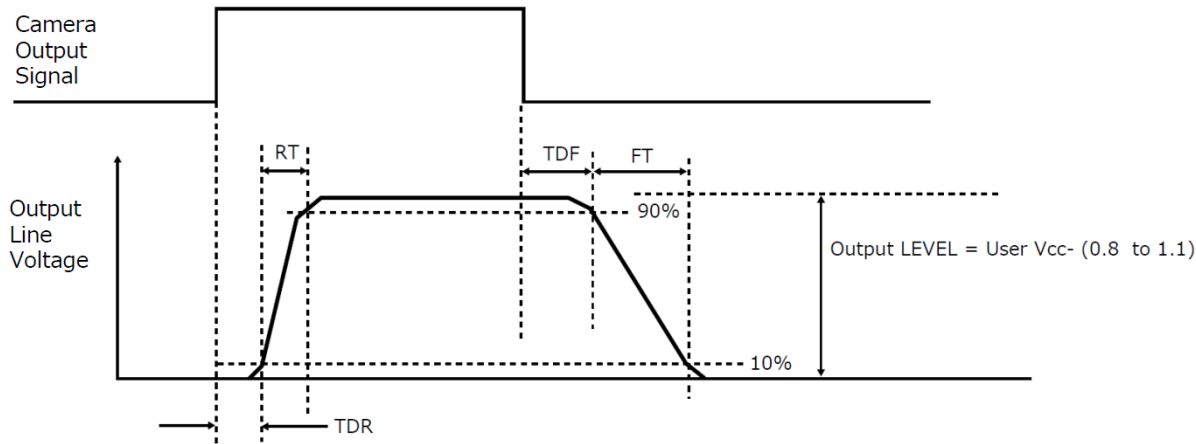

For the operating conditions of applied voltage (User Power) +12V, load resistance 10kΩ, and cable length 1m, the timing is shown in the table below.

Item	Result (Typ)
TDR (Time Delay Rise)	0.48 (μs)
RT (Rise Time)	3.08 (μs)
TDF (Time Delay Fall)	3.16 (μs)
FT (Fall Time)	52.4 (μs)

**Note:** Since it varies depending on the applied voltage, load resistance, cable length, etc., check the actual environment before use.

#### Cautions:

Please note that the recommended load resistance of Opto output is 10 kΩ (rated 1/10 W) or more. The 270 Ω resistor shown in the circuit diagram is the MINIMUM resistance that should be used. The response speed from On (High) to Off (Low) depends on the voltage applied to Opto output and the value of the load resistance. Higher load resistance results in a slower response. If the response at 10 kΩ is slower than desired, you can try reducing the load resistance in order to increase the response speed but DO NOT go below the minimum 270 Ω value.

The load resistance loss can be calculated as follows.

$$\text{load resistance loss} \approx (\text{voltage applied to Opto output})^2 / (\text{load resistance})$$

# Preparation

Read this section to learn how the camera connects to devices and accessories. The preparation process is described below.

1	<p><b><u>Step 1: Install the Software (First Time Only)</u></b></p> <ul style="list-style-type: none"> <li>• Install the software for configuring and controlling the camera (eBUS SDK for JAI) on the computer.</li> </ul>
2	<p><b><u>Step 2: Connect Devices</u></b></p> <ul style="list-style-type: none"> <li>• Verify whether the camera is turned on and ready for use.</li> </ul>
3	<p><b><u>Step 3: Verify Camera Operation</u></b></p> <ul style="list-style-type: none"> <li>• Verify whether the camera is turned on and ready for use.</li> </ul>
4	<p><b><u>Step 4: Verify the Connection between the Camera and PC</u></b></p> <ul style="list-style-type: none"> <li>• Verify whether the camera is properly recognized via Control Tool.</li> </ul>
5	<p><b><u>Step 5: Change the Camera Settings</u></b></p> <ul style="list-style-type: none"> <li>• Refer to the procedure for changing the output format setting as an example, and change various settings as necessary.</li> </ul>
6	<p><b><u>Step 6: Adjust the Image Quality</u></b></p> <ul style="list-style-type: none"> <li>• Refer to the procedures for adjusting the gain, white balance, and black level as examples, and adjust the image quality.</li> </ul>
7	<p><b><u>Step 7: Save the Settings</u></b></p> <ul style="list-style-type: none"> <li>• Save the current setting configurations in user memory.</li> </ul>



## Step 1: Install the Software (First Time Only)

When using the camera for the first time, install the software for configuring and controlling the camera (eBUS SDK for JAI) on the computer.

**Note:** When you install eBUS SDK for JAI, eBUS Player for JAI will also be installed.

1. Download the eBUS SDK for JAI from the JAI website (<https://www.jai.com/support-software/jai-software>).
2. Install eBUS SDK for JAI on the computer.

## Step 2: Connect Devices

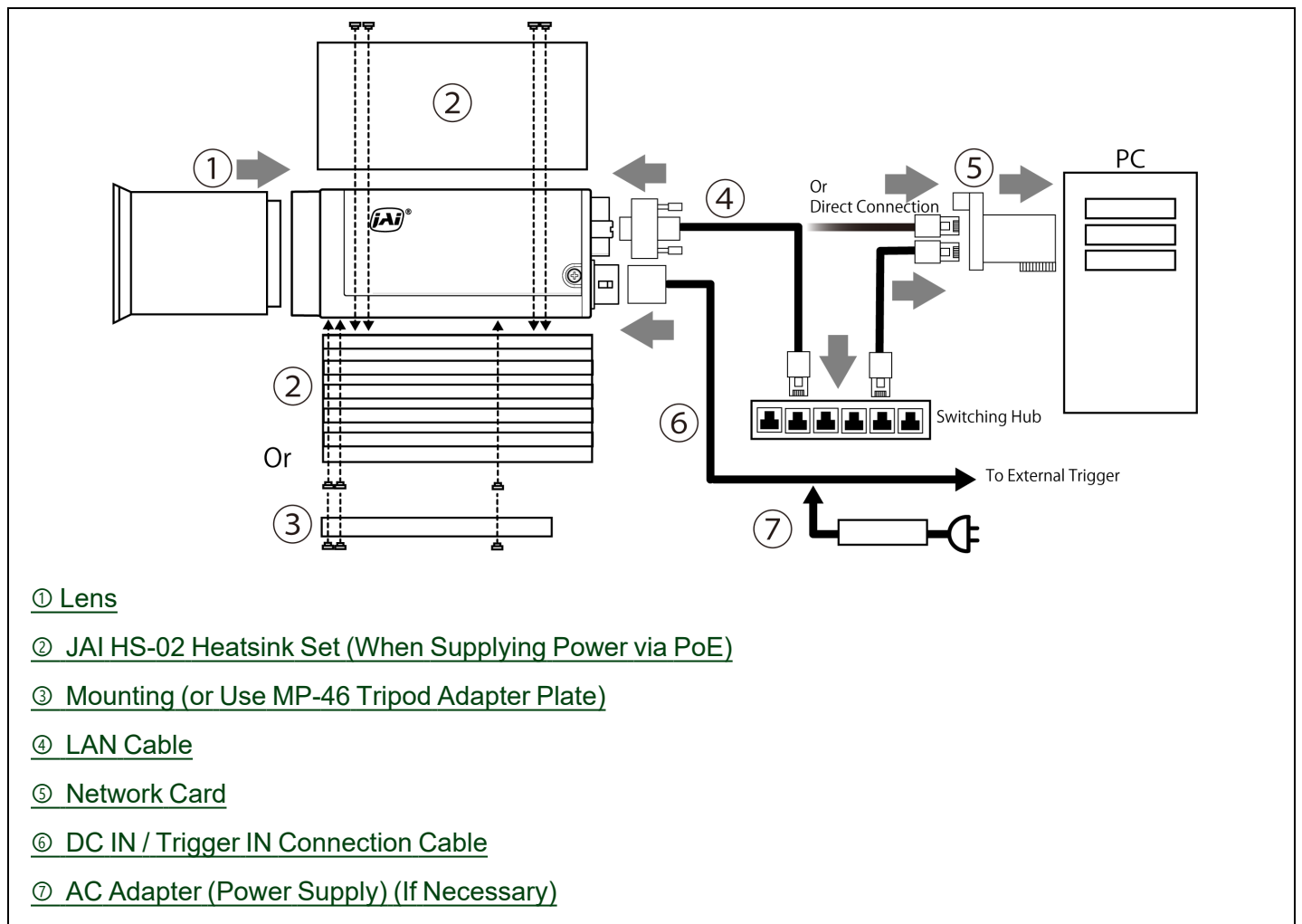

## ① Lens

### Technical Notes Lens Selection Guide

C-mount lenses with lens mount protrusions of 9 mm or less can be attached.

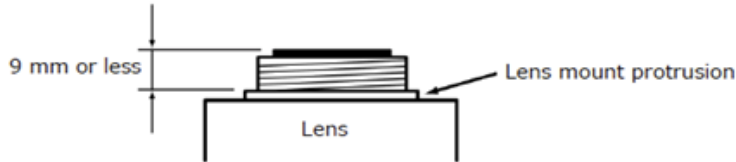

To prevent vignetting and to obtain the optimal resolution, use a lens that will cover the image sensor size.

Model Name	Image Sensor		
GOX-5105M-5GE	Mono	Type 1/1.8	6.8 mm x 5.7 mm (8.82mm diagonal)
GOX-5105C-5GE	Color		
GOX-8105M-5GE	Mono	Type 2/3	7.8 mm x 7.8 mm (11.05mm diagonal)
GOX-8105C-5GE	Color		
GOX-12405M-5GE	Mono	Type 1/1.1	11.3 mm x 8.2 mm (14.00mm diagonal)
GOX-12405C-5GE	Color		
GOX-16205M-5GE	Mono	Type 1.1	14.6 mm x 8.3 mm (16.81mm diagonal)
GOX-16205C-5GE	Color		
GOX-20405M-5GE	Mono	Type 1.1	12.4 mm x 12.4 mm (17.48mm diagonal)
GOX-20405C-5GE	Color		
GOX-24505M-5GE	Mono	Type 1.2	14.6 mm x 12.6 mm (19.30mm diagonal)
GOX-24505C-5GE	Color		

**Note:** The following formula can be used to estimate the focal length.

- Focal length =  $WD / (1 + W/w)$
- WD: Working distance ( distance between lens and object )
- W: Width of object
- w: Width of sensor

**Cautions:**

- The maximum performance of the camera may not be realized depending on the lens.
- Attaching a lens with a mount protrusion of 9 mm or longer may damage the lens or camera.

**② JAI HS-02 Heatsink Set (When Supplying Power via PoE)**

When operating this camera with a PoE power supply without limiting the LAN cable length and frame rate, attach the JAI HS-02 heatsink set (sold separately) to the camera.

**Note:** If you operate this camera without attaching the JAI HS-02 heatsink set, follow the Operating Condition 2 on the [Notes on Supplying Power via PoE](#) topic.

**How to Attach/Mount****■ Attach to the Camera**

The JAI HS-02 heatsink set consists of two parts: upper part and lower part. Use the supplied screws to attach the JAI HS-02 heatsink set to the camera.

- Lower part (x 3): Attach to the camera (screw holes: **Green**).
- Upper part (x 4): Attach the upper part to the lower part of the heatsink (screw holes: **Blue**).

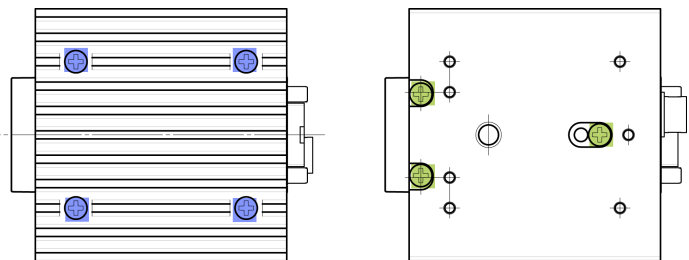

**Caution:** Attach both the lower and upper heatsink parts to ensure adequate heat dissipation.

## ■ Mounting the Heatsink

You can attach the JAI HS-02 heatsink to a tripod or mount the heatsink on a wall or other devices using the screw holes on the lower part of the heatsink.

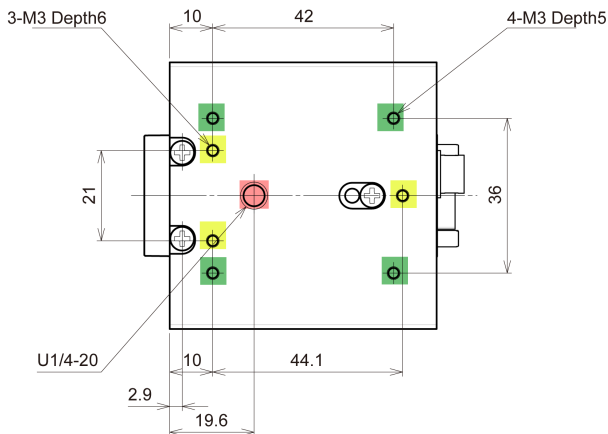

- When attaching to a tripod, use the tripod screw hole (U1/4-20: **Red**).
- When mounting to other mechanical components, use M3 screw holes.

M3: Depth 6mm	Screw holes: <b>Yellow</b> (x3)
M3: Depth 5mm	Screw holes: <b>Green</b> (x4)

## ③ Mounting (or Use MP-46 Tripod Adapter Plate)

When mounting the camera directly to a wall or other device, use screws that match the mounting holes on the camera (M3: depth 4mm for the lower part, depth 3 mm for the upper part).

Use the supplied screws to attach the tripod adapter plate (lower mounting holes).

**Caution:** For heavy lenses, be sure to support the lens itself. Do not use configurations in which its weight is supported by the camera.

## ④ LAN Cable

Connect a LAN cable to the RJ-45 connector.

**Caution:** See the [Notes on LAN Cable Connection](#) topic.

The camera supports the following Ethernet standards: 1000BASE-T, 2.5GBASE-T, 5GBASE-T.

- Use a LAN cable that is Category 5e or higher (Category 6 recommended).
- Use a LAN cable that is an STP cable.
- When supplying power via PoE, connect to a PoE-compatible switching hub or a PoE-compatible network card.
- Refer to the specifications of the cable for details on its bend radius.

The longest cable length varies depending on the type of LAN cable and the Ethernet standard. Below, the table shows the relationship diagram between LAN cable type and Ethernet standard. Correctly select the LAN cable type according to the Ethernet standard to be used.

**Caution:** When providing power via PoE without a JAI HS-02 heatsink set, the maximum cable length will be less than 10m. For more information, see [Notes on Supplying Power via PoE](#).

	Cat5e	Cat6/Cat6e	Cat6A	Cat7
1000BASE-T	100m	100m	100m	100m
2.5GBASE-T	100m	100m	100m	100m
5GBASE-T	-	100m	100m	100m

## ⑤ Network Card

Install this in the computer that will be used to configure and operate the camera. As the camera supports PoE, you can also use PoE-compatible network cards. Refer to the instruction manual of the network card and configure settings on the computer as necessary.

**Note:** JAI does not recommend using a PoE injector. If a PoE injector is used, the camera may not be able to transmit images properly.

## ⑥ DC IN / Trigger IN Connection Cable

Performs external I/O such as power supply and trigger input.

## ⑦ AC Adapter (Power Supply) (If Necessary)

Connect the AC adapter and the round connector of the connection cable to the DC IN / Trigger IN connector on the camera.

## Step 3: Verify Camera Operation

---

When power is supplied to the camera while the necessary equipment is connected, the POWER/TRIG LED at the rear of the camera lights amber, and initialization of the camera starts. When initialization is complete, the POWER/TRIG LED lights green.

Verify whether power is being supplied to the camera by checking the rear LED. When properly turned on, the power LED is lit green.

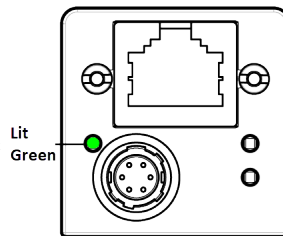

For details on how to read the LEDs, see the [⑤ POWER/TRIG LED](#) section.

## Step 4: Verify the Connection between the Camera and PC

Verify whether the camera is properly recognized via Control Tool.



1. Launch eBUS Player for JAI. 
2. Select the camera you want to configure. Click the **Select / Connect** button.

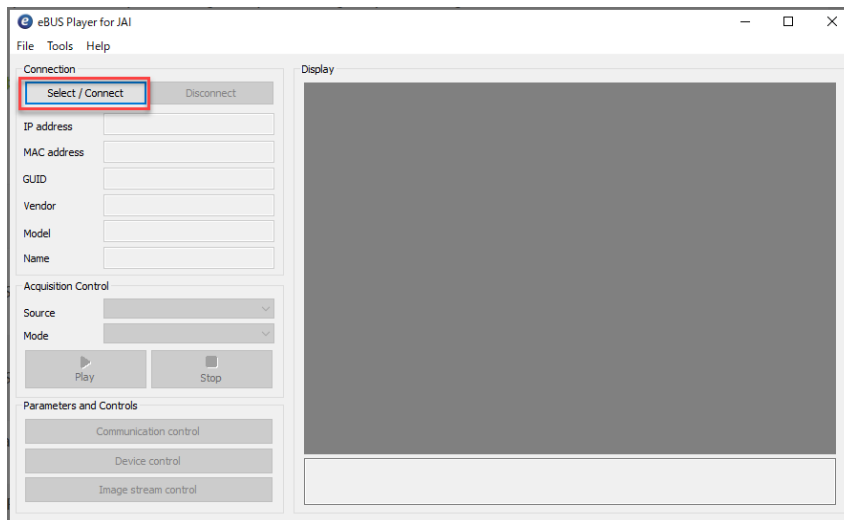

3. The connected camera is listed. Please select one camera and click **OK**.

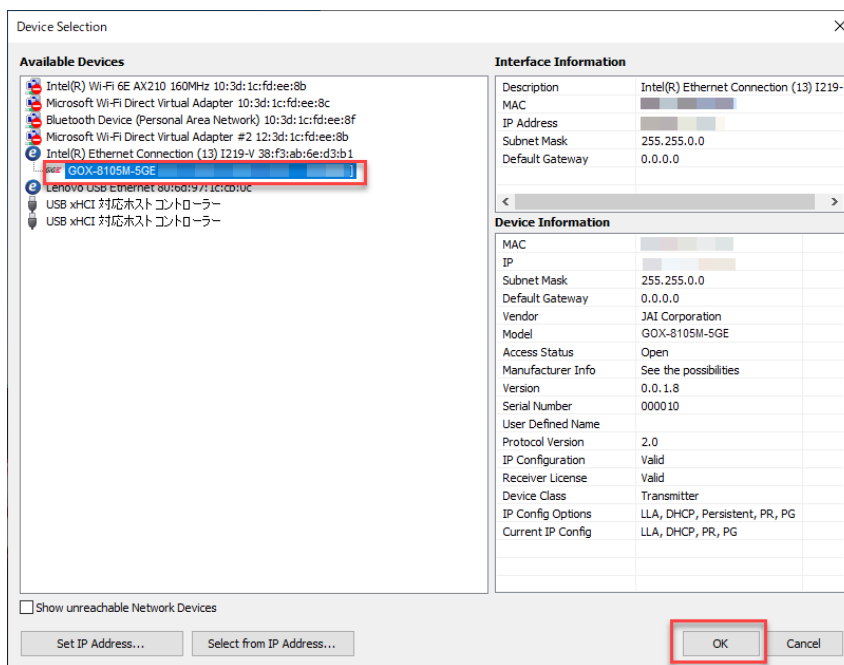

4. Check that the settings of the selected camera are displayed.

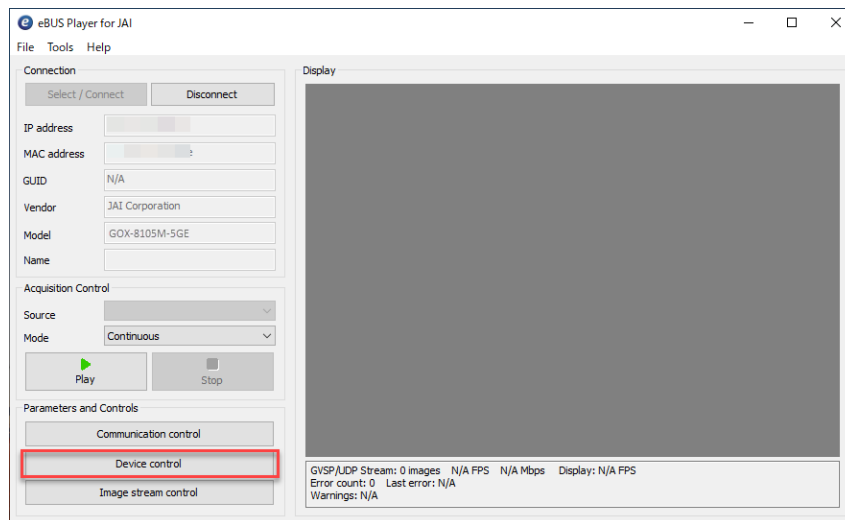

5. Click the **Device control** button. The screen shown below will be displayed. In this window, you can adjust various settings of the camera.

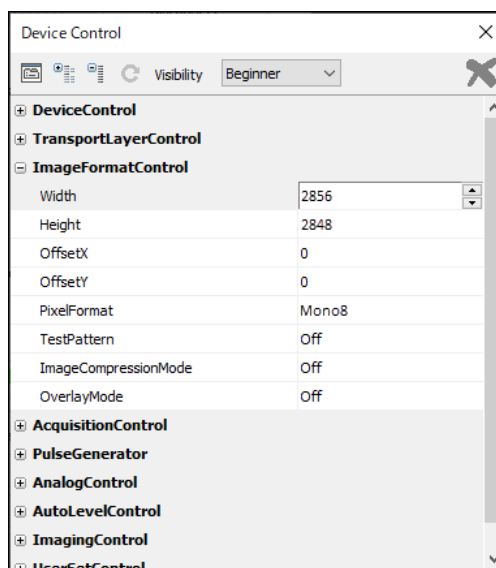

This completes the procedure for verifying whether the camera is properly recognized and whether control and settings configuration are possible.



## Step 5: Change the Camera Settings

This section explains how to change settings by describing the procedure for changing the output format as an example.

### Configure the Output Format

Configure the size, position, and pixel format of the images to be acquired. The factory settings are as follows. Change the settings as necessary.

#### Factory default values (GOX-8105M-5GE)

Item		Default Value
ImageFormatControl	Width	2856
	Height	2848
	OffsetX	0
	OffsetY	0
	PixelFormat	Mono8

**Note:** You can specify the image acquisition area. For details, see [“ROI Function \(Single ROI\)”](#).

### Example: Configure the Width of ImageFormatControl

1. By selecting the item of Width, you can change the value as shown below.

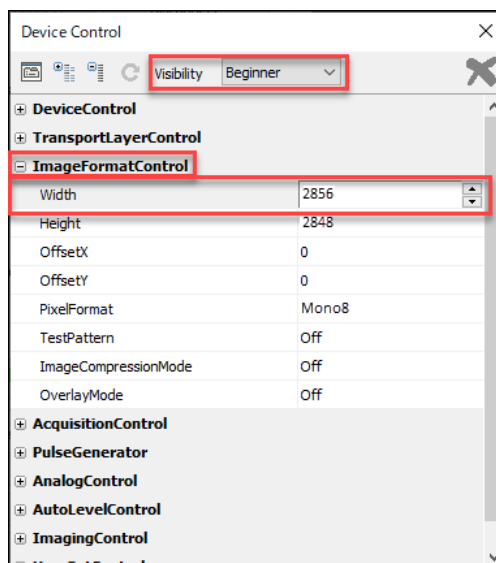

**Note:** Depending on the setting item, you need to change visibility. Please switch visibility (Beginner / Expert / Guru) as necessary.

## Step 6: Adjust the Image Quality

Related Setting Items: [AnalogControl](#)

Display the camera image and adjust the image quality.

### Display the Image

Display the image captured by the camera. When you click the **Play** button, the camera image appears in the right area.

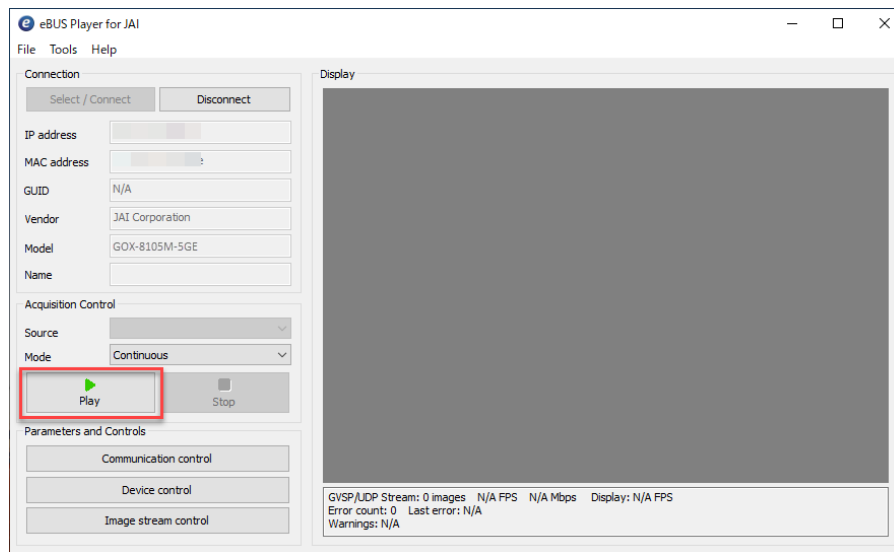

**Note:** It is recommended to set **GevGVCPPendingAck** in [TransportLayerControl](#) to **True**. When a time-consuming process such as white balance is performed, this camera returns an Ack response when the process is completed. In this case, some camera control software may cause a timeout error without waiting for an Ack response from the camera. When the **GevGVCPPendingAck** setting is enabled, if a time-consuming process is performed, the camera immediately returns a Pending Ack response and returns an Ack response when the processing is completed. The Timeout errors are prevented.

## Adjust the Gain

Adjust the image quality using the gain and white balance functions. The Visibility must be changed from Beginner to **Guru**.

**Note:** For details on the Gain control, see [Gain Control](#) in the Main Functions chapter.

### Manual Adjustment

1. Expand **AnalogControl**, and set GainAuto to **Off** (Default = Off).

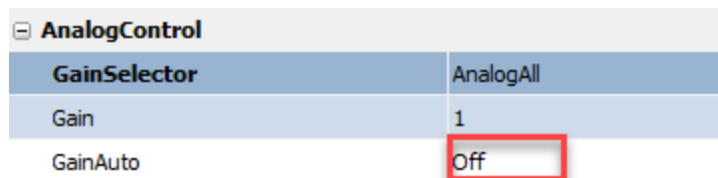

2. Select the gain you want to configure in GainSelector. AnalogAll (master gain), DigitalRed\* (digital R gain), and DigitalBlue\* (digital B gain) can be configured.

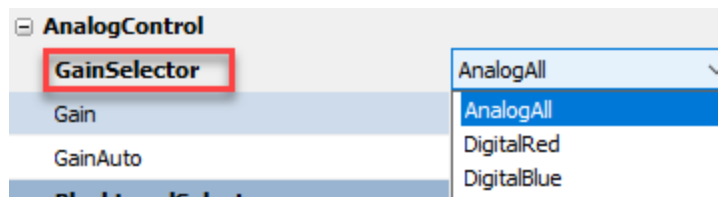

3. Configure the Gain.

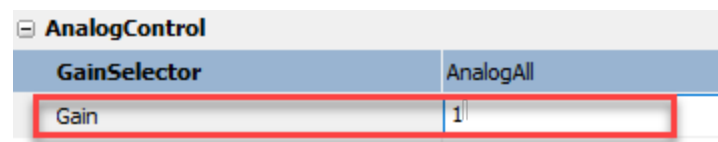

- DigitalAll (master gain) can be set to a value from x1 to x126 the analog gain value. The resolution is set in about 0.1dB steps. Values are configured by multipliers.
- The DigitalRed\* (digital R gain) and DigitalBlue\* (digital B gain) can be set to a value from x0.447 to x5.624. Values are configured by multipliers.

**Note:** \*Color models only.

## Adjust the White Balance

Adjust the white balance using the automatic adjustment function.

**Note:** The white balance is only supported on color models.

### Automatic White Balance Adjustment

1. Place a white sheet of paper or similar object under the same lighting conditions as the intended subject, and zoom in to capture the white.

White objects near the subject, such as a white cloth or wall, can also be used. Be sure to prevent the high-intensity spotlights from entering the screen.

2. Select the **BalanceWhiteAuto** tab, and select **Continuous** or **Once** for the adjustment method.

AnalogControl	
<b>GainSelector</b>	AnalogAll
Gain	1
GainAuto	Off
<b>BlackLevelSelector</b>	All
BlackLevel	0
BalanceWhiteAuto	Off
<b>AWBAreaSelector</b>	Off
AWBAreaEnable	Once
	Continuous

The white balance is automatically adjusted.

**Note:** For Continuous and Once, white balance is adjusted using R/B Gain.

## Adjust the Black Level

1. Expand **AnalogControl**, and select the black level you want to configure in **BlackLevelSelector**. All (master black), Red\* (digital R), and Blue\* (digital B) can be configured.

**Note:** \*Color models only.

AnalogControl	
<b>GainSelector</b>	AnalogAll
Gain	1
GainAuto	Off
<b>BlackLevelSelector</b>	All
BlackLevel	All
BalanceWhiteAuto	Red
<b>AWBAreaSelector</b>	Blue

2. Specify the adjustment value in BlackLevel.

AnalogControl	
<b>GainSelector</b>	AnalogAll
Gain	1
GainAuto	Off
<b>BlackLevelSelector</b>	All
<b>BlackLevel</b>	0

## Step 7: Save the Settings

### Related Setting Items: [UserSetControl](#)

The setting values configured in eBUS SDK for JAI will be deleted when the camera is turned off. By saving current setting values to user memory, you can load and recall them whenever necessary. You can save up to three sets of user settings in the camera. (User Set1 to 3)

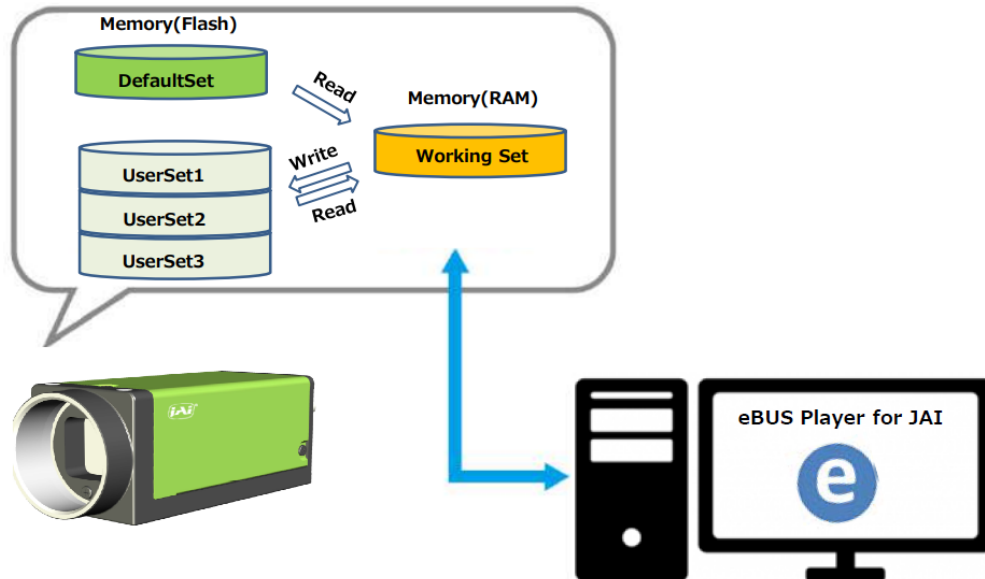

### Notes:

- Changes to settings are not saved to the computer (eBUS SDK for JAI).
- The camera has non-volatile flash memory for users to store data; however, images should be saved to a PC or other storage location using eBUS Player for JAI (Image and Video Saving Options).

## To Save User Settings

1. Stop image acquisition.
2. Expand **UserSetControl**, and select the save destination (UserSet1 to UserSet3) in UserSetSelector.

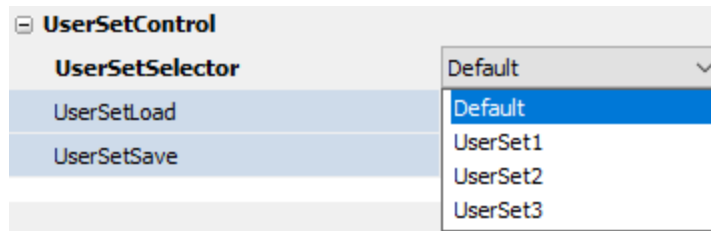

**Note:** The factory default setting values are stored in Default and cannot be overwritten.

**Caution:** Settings can only be saved when image acquisition on the camera is stopped.

3. Select **UserSetSave**, and click the **UserSetSave** button.

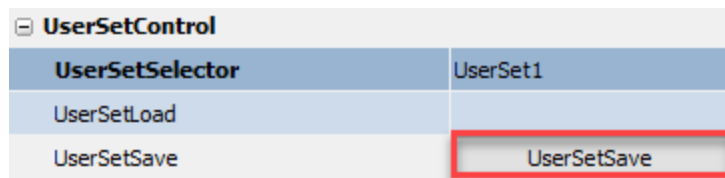

4. The current setting values are saved as user settings.

## To Load User Settings

1. Stop image acquisition. User settings can only be loaded when image capture on the camera is stopped.
2. Select the settings to load (UserSet1 to UserSet3) in UserSetSelector.

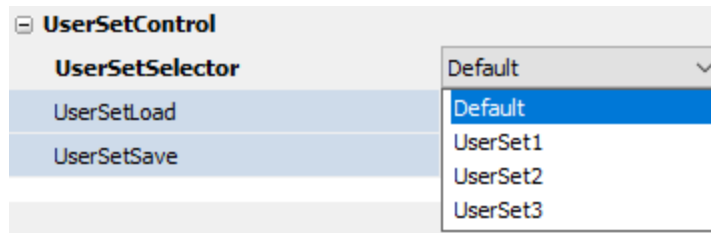

3. Select **UserSetLoad**, and click the **UserSetLoad** button.

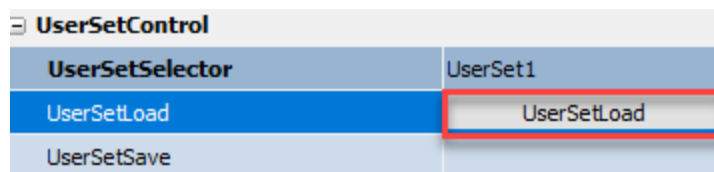

4. The selected user settings are loaded.

**Note:** When selecting **Default** for UserSetSelector, the factory settings are loaded.



# Main Functions

This chapter describes the camera's main functions.

## Acquisition Control

**Related Setting Items:** [AcquisitionControl](#)

This camera has three Acquisition modes (SingleFrame, MultiFrame, Continuous). Use the AcquisitionControl settings to perform operations and settings for image capture.

### SingleFrame

When the AcquisitionStart command is executed, one frame of image is captured.



### MultiFrame

When the AcquisitionStart command is executed, the number of frames set in AcquisitionFrameCount are acquired as images.

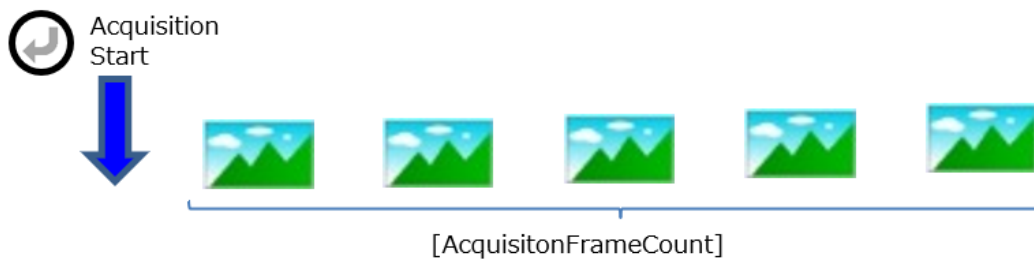

### Continuous

When the AcquisitionStart command is executed, images will continue to be acquired until the AcquisitionStop command is executed.



**Note:** After changing various settings, the black level may not be stable for several frames immediately after AcquisitionStart.

## Changing the Frame Rate

When TriggerMode is disabled, you can change the frame rate in AcquisitionFrameRate.

The shortest frame period varies depending on the Width, Height, PixelFormat, SensorDigitizationBits, Binning(Horizontal/Vertical), FD2x2BinningMode, ImageScalingMode, Decimation (Horizontal/Vertical), ChunkModeActive, GevSCPSPacketSize, GevSCPD, NetworkThroughputSafetyMargin settings.

The NetworkThroughputSafetyMargin setting (in [TransportLayerControl](#)) controls how much of the available GigE Vision bandwidth can be used to transmit image data. The default value is 92 (percent). You can shorten the frame period (increase the frame rate) by increasing this value, however at values above 92, abnormal images may be observed. If abnormal images are observed, lower the value.

The longest frame period is 0.125 Hz (8 sec.).

**Note:** When TriggerMode[FrameStart] is enabled, the AcquisitionFrameRate setting is disabled.

## Exposure Mode

**Related Setting Items:** [AcquisitionControl](#)

This camera has three Exposure modes (Off, Timed, TriggerWidth). Use the AcquisitionControl settings to perform operations and settings for exposure.

### ■ ExposureMode = Off

Exposure control is not performed (free-running operation). The exposure time is the longest possible time within the operating conditions such as the frame rate.

### ■ ExposureMode = Timed

Mode in which control is performed using ExposureTime. Acquire images using an exposure time configured beforehand on an external trigger.

In this mode, the exposure time can be adjusted automatically by setting ExposureAuto. For details, refer to [ALC \(Automatic Level Control\) Function](#).

### ■ ExposureMode = TriggerWidth

Mode in which control of the exposure time is performed using the pulse width of the trigger input signal. The exposure time will be the same as the pulse width of the trigger input signal.

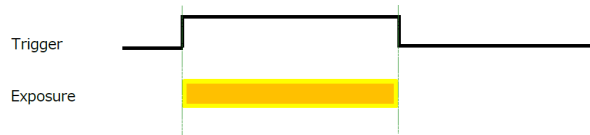

#### Notes:

- The settings for exposure control and triggers are related to each other. Be sure to configure the settings described in [Trigger Control](#).
- When exposed to strong light, the accumulation time may appear to shift due to PLS (Parasitic Light Sensitivity) and other effects.

## Actual Exposure Time

**Related Setting Items:** [AcquisitionControl](#)

When ExposureMode is set to **Timed**, the actual exposure time will consist of the image sensor's offset duration (approx. 2.45us) added to the ExposureTime setting configured on the camera.

**Actual Exposure Time:** *ExposureTime* value (us) + 2.45us

**Note:** On this camera, the ExposureActive signal's pulse width includes the Exposure offset duration (2.45us). Therefore, "ExposureActive signal's pulse width = *ExposureTime* value (us) + 2.45(us)."

## RCT Mode

**Related Setting Items:** [AcquisitionControl](#)

In RCT mode, the image is not output from the camera until FrameStartTrigger is input, but internally the imaging operation is continued and the automatic gain control (AGC) function, the automatic shutter control (ASC) function and the automatic white balance (AWB) function can be continued.

You can use RCT mode when:

- **ExposureMode** is set to **Timed**, and **FrameStartTriger** is set to **On**.
- [Sequencer Function](#) = **Off**
- **AcquisitionMode** = **Continuous**

### Notes:

- In RCT mode, the start timing of background exposure after receiving a trigger input is 100 ms after the end of the trigger mask period.



# Trigger Control

**Related Setting Items:** [AcquisitionControl](#)

The camera allows the following controls to be performed via external trigger signals.

TriggerSelector	Description																																															
AcquisitionStart	Start image acquisition in response to the external trigger signal input.																																															
AcquisitionEnd	Stop image acquisition in response to the external trigger signal input.																																															
FrameStart	<p>Start capturing a one-frame image in response to the external trigger signal input. Select this to perform exposure control using external triggers.</p> <p><b>Note:</b> The FrameStart Trigger can only be used when the <a href="#">Exposure Mode</a> setting is set to <b>Timed</b> or <b>TriggerWidth</b>.</p>																																															
AcquisitionTransfer Start	<p>Start output of acquired image data in response to external trigger signal input (delayed readout). The number of frames that can be acquired depends on the model and <a href="#">Pixel Format</a> setting.</p> <p style="text-align: center;"><b>Number of Frames That Can Be Acquired (Full ROI)</b></p> <table border="1" style="width: 100%; border-collapse: collapse;"> <thead> <tr> <th rowspan="2"></th> <th colspan="5">PixelFormat</th> </tr> <tr> <th style="text-align: center;">Mono8 Bayer8</th> <th style="text-align: center;">Mono10Packed Mono12Packed Bayer10Packed Bayer12Packed</th> <th style="text-align: center;">Mono10 Mono12 Bayer10 Bayer12</th> <th style="text-align: center;">RGB8</th> <th style="text-align: center;">RGB10V1Packed RGB10p32</th> </tr> </thead> <tbody> <tr> <td>GOX-5105MC-5GE</td> <td style="text-align: center;">25</td> <td style="text-align: center;">17</td> <td style="text-align: center;">13</td> <td style="text-align: center;">8</td> <td style="text-align: center;">6</td> </tr> <tr> <td>GOX-8105MC-5GE</td> <td style="text-align: center;">16</td> <td style="text-align: center;">10</td> <td style="text-align: center;">8</td> <td style="text-align: center;">5</td> <td style="text-align: center;">4</td> </tr> <tr> <td>GOX-12405MC-5GE</td> <td style="text-align: center;">10</td> <td style="text-align: center;">7</td> <td style="text-align: center;">5</td> <td style="text-align: center;">3</td> <td style="text-align: center;">2</td> </tr> <tr> <td>GOX-16205MC-5GE</td> <td style="text-align: center;">8</td> <td style="text-align: center;">5</td> <td style="text-align: center;">4</td> <td style="text-align: center;">2</td> <td style="text-align: center;">2</td> </tr> <tr> <td>GOX-20405MC-5GE</td> <td style="text-align: center;">6</td> <td style="text-align: center;">4</td> <td style="text-align: center;">3</td> <td style="text-align: center;">2</td> <td style="text-align: center;">1</td> </tr> <tr> <td>GOX-24505MC-5GE</td> <td style="text-align: center;">5</td> <td style="text-align: center;">3</td> <td style="text-align: center;">2</td> <td style="text-align: center;">1</td> <td style="text-align: center;">1</td> </tr> </tbody> </table> <p><b>Conditions:</b> Full ROI, ChunkModeActite = True, GevSCPSPacketSize = 12036 (MAX)</p>		PixelFormat					Mono8 Bayer8	Mono10Packed Mono12Packed Bayer10Packed Bayer12Packed	Mono10 Mono12 Bayer10 Bayer12	RGB8	RGB10V1Packed RGB10p32	GOX-5105MC-5GE	25	17	13	8	6	GOX-8105MC-5GE	16	10	8	5	4	GOX-12405MC-5GE	10	7	5	3	2	GOX-16205MC-5GE	8	5	4	2	2	GOX-20405MC-5GE	6	4	3	2	1	GOX-24505MC-5GE	5	3	2	1	1
			PixelFormat																																													
		Mono8 Bayer8	Mono10Packed Mono12Packed Bayer10Packed Bayer12Packed	Mono10 Mono12 Bayer10 Bayer12	RGB8	RGB10V1Packed RGB10p32																																										
	GOX-5105MC-5GE	25	17	13	8	6																																										
	GOX-8105MC-5GE	16	10	8	5	4																																										
	GOX-12405MC-5GE	10	7	5	3	2																																										
	GOX-16205MC-5GE	8	5	4	2	2																																										
	GOX-20405MC-5GE	6	4	3	2	1																																										
GOX-24505MC-5GE	5	3	2	1	1																																											

**Notes:**

- The number of MAX frames that can be acquired depends on the PayloadSize per frame; therefore, in addition to the PixelFormat setting, the below settings will also affect the number of frames that can be acquired (including cases where the below settings are changed due to changes of other setting items).
  - Width ([ImageFormatControl](#)), Height ([ImageFormatControl](#)), ChunkModeActive ([ChunkDataControl](#)), GevSCPSPacketSize ([TransportLayerControl](#))
- The settings for exposure control and triggers are related to each other. Be sure to configure the settings described in [Exposure Mode](#).
- You can delay when exposure actually starts after a trigger is received for a specific amount of time by configuring **TriggerDelay**.

Select the trigger type with TriggerSelector and set the following items for each trigger.

TriggerMode	Switch enable or disable.
TriggerSource	<p>Select the source signal (PulseGenerator0-3, UserOutput0-3, Action0-3, Software, Line5 Opt In, Nand0 Out, Nand1 Out).</p> <p><b>Note:</b> Trigger can be executed by TriggerSoftware[TriggerSelector] command only when Software is set.</p>
TriggerActivation	Sets the polarity of the trigger signal.
TriggerDelay	<p>You can specify a delay after receiving the trigger signal until the trigger is enabled.</p> <p><b>Note:</b> This trigger type is available only when TriggerSelector is set to <b>FrameStart</b>.</p>

## When Using the FrameStart Trigger

When AcquisitionStart is executed and a FrameStart trigger is received before the AcquisitionStop command is executed, one frame is acquired.

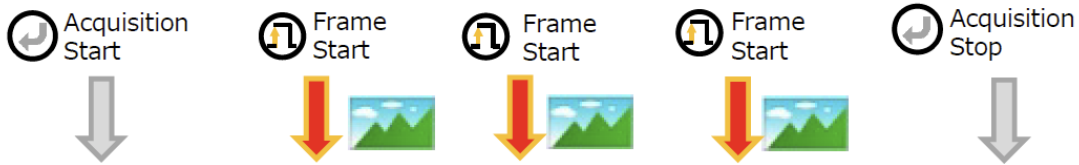

The source signals that can be set for the AcquisitionStart, AcquisitionEnd, FrameStart, and AcquisitionTransferStart triggers are as follows:

- Software, PulseGenerator 0 – 3, UserOutput 0 – 3, Action 0 – 3, Line5 Opt In 1, NAND0 Out, and NAND1 Out.

### FrameStart and AcquisitionTransferStart Triggers

On this camera, when **AcquisitionTransferStart** is set to **On**, the camera expects that the number of **AcquisitionTransferStart** trigger inputs is the same as the number of **FrameStart** trigger inputs. Otherwise, a GVSP error may occur.



For example, if the FrameStart trigger is issued 100 times but the AcquisitionTransferStart trigger is issued only once, the camera attempts to send the first frame, but a GVSP Error will be sent instead because the first frame is already discarded. The below shows an example of when the camera can hold up to 10 frames in the frame memory.

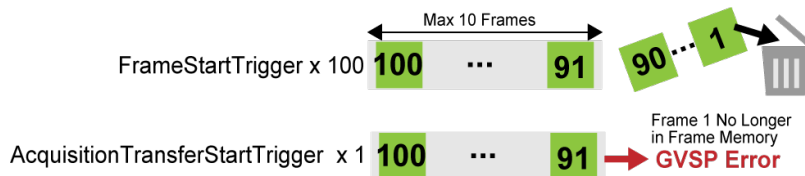

To output an image, the AcquisitionTransferStart trigger must be issued continuously until it reaches the number of frames in the frame memory. For example, if 10 frames remain in the frame memory, the AcquisitionTransferStart trigger must be issued 90 more times to output the image.

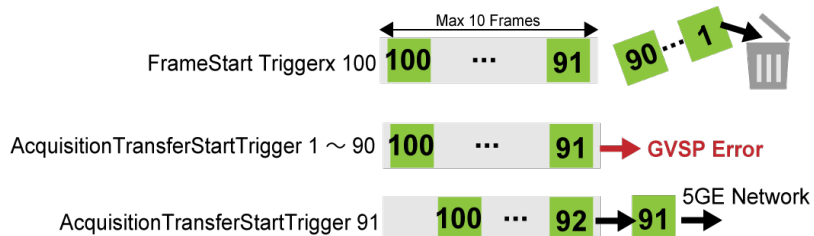

# Pixel Format

Related Setting Items: [ImageFormatControl](#)



Technical Notes

Pixel Format Alignments for GigE Vision

Selectable PixelFormat is as follows.

Color models	<p>BayerRG8 (default), BayerRG10, BayerRG10Packed, BayerRG12, BayerRG12Packed, BayerGR8*, BayerGR10*, BayerGR10Packed*, BayerGR12*, BayerGR12Packed*, BayerGB8*, BayerGB10*, BayerGB10Packed*, BayerGB12*, BayerGB12Packed*, BayerBG8*, BayerBG10*, BayerBG10Packed*, BayerBG12*, BayerBG12Packed*, RGB8**, RGB10V1Packed**, RGB10p32**</p> <p><b>Notes:</b></p> <ul style="list-style-type: none"> <li>• *When using ReverseX, ReverseY.</li> <li>• **<b>RGB8, RGB10V1Packed, RGB10p32</b>: Utilize 5x5 Debayering</li> </ul>
Mono models	Mono8 (default), Mono10, Mono10Packed, Mono12, Mono12Packed

**Notes:**

On color models, the Bayer array is changed by the [Image Flip Function](#).

- ReverseX : 0 (False), ReverseY : 0 (False) -> BayerRG
- ReverseX : 0 (False), ReverseY : 1 (True) -> BayerGB
- ReverseX : 1 (True), ReverseY : 0 (False) -> BayerGR
- ReverseX : 1 (True), ReverseY : 1 (True) -> BayerBG



## Image Flip Function

Related Setting Items: [ImageFormatControl](#)

Using this function, you can output the image by inverting it horizontally and/or vertically.

### ReverseX, ReverseY

- To reverse the image horizontally, set **ReverseX** to True.
- To reverse the image vertically, set **ReverseY** to True.

On color models, when [Pixel Format](#) is set to **BayerRGxxx**, the Bayer array is changed by the Image Flip function.

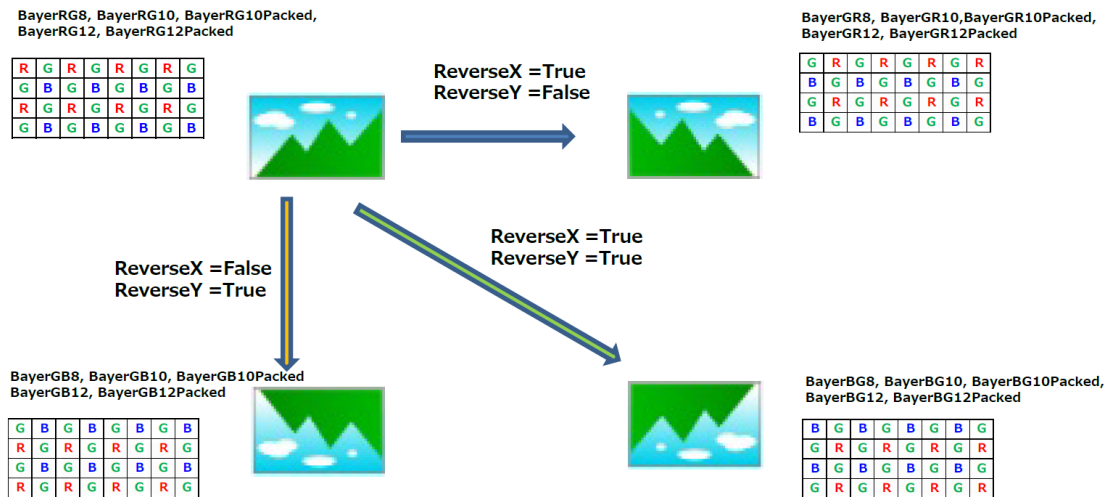

### ReverseXY

ReverseXY inverts the current **ReverseX** and **ReverseY** settings.

**Note:** The ReverseXY setting can be changed during the acquisition; however, the frame rate will temporarily slow down while the setting is changed.

For example, if ReverseX, ReverseY, and ReverseXY are all set to **False**, changing ReverseXY to **True** will change ReverseX and ReverseY to **True**. If ReverseXY is changed back to **False**, ReverseX and ReverseY are also changed back to **False**. (ReverseXY acts as a toggle).



## SensorDigitizationBits

---

**Related Setting Items:** [ImageFormatControl](#)

You can use SensorDigitizationBits to select the sensor output bits for this camera (8bits, 10bits, and 12bits: default = 10bits).

### Notes:

- When SensorDigitizationBits is set to "8Bits", the sensitivity is 4 times higher than when set to 10Bits/12Bits.
- If SensorDigitizationBits is set to smaller than the pixel format bits configured in the [Pixel Format](#), the image may have gaps in histogram.
- When [Gradation Compression Mode](#) is set to On, SensorDigitizationBits is not configurable (maintains 10bits or 12bits).

## GPIO (Digital Input/Output Settings)

**Related Setting Items:** [DigitalIOControl](#)

The camera can input/output the following signals to and from external input/output connectors.

External Output	Line2 : Opt Out	DC IN / TRIG IN Connector (6-pin round)
Internal Output	Line5 : Opt In	DC IN / TRIG IN Connector (6-pin round)

These signals can be used as triggers and other necessary signals within the camera or as signals output from the camera to the system, such as those used for lighting equipment control.

**Note:** See [Recommended Circuit Diagram \(Reference Examples\)](#) for recommended external circuit examples.

Use the [DigitalIOControl](#) to set the digital input/output. Select input or output in LineSelector, you can check LineMode, LineFormat, and set LineInverter. You can also check the status of each digital I/O as shown in the table below with LineStatusAll.

LineSelector	LineMode	LineFormat	LineInverter	LineStatusAll	LineSource	
Line2 (Opt Output1)	Output	OptCoupled	True/False	bit1	Available (Default = Line5)	DC IN / TRG IN connector
Line5 (Opt In 2)	Input	OptCoupled	False (fixed)	bit4	Invalid	DC IN / TRG IN connector
Nand0In1	Input	InternalSignal	True/False	bit12	Available (Default = Line5)	
Nand0In2	Input	InternalSignal	True/False	bit13		
Nand1In1	Input	InternalSignal	True/False	bit14		
Nand1In2	Input	InternalSignal	True/False	bit15		
TimestampReset	Internal Connection	InternalSignal	False (fixed)		Available (Default = Off)	

For digital output, set the output source signal using LineSource. Set the source signal in the same way for NAND Logic (Nand0In1, Nand0In2, Nand1In1, NandIn2) and TimestampReset.

The table below shows the source signals that can be set.

LineSelector	Off	AcquisitionActive	FrameActive	ExposureActive	FVAL	LVAL	PulseGenerator0	PulseGenerator1	PulseGenerator2	PulseGenerator3	UserOutput0	UserOutput1	UserOutput2	UserOutput3	Action0	Action1	Action2	Action3	Lines Opt In1	NAND0 Out	NAND1 Out	Low	High	AcquisitionTriggerWait	FrameTriggerWait
Line2		✓	✓	✓	✓		✓	✓	✓	✓	✓	✓	✓	✓					✓	✓	✓	✓	✓	✓	✓
Line5																									
Nand0In1		✓	✓	✓	✓		✓	✓	✓	✓	✓	✓	✓	✓					✓		✓	✓	✓	✓	✓
Nand0In2		✓	✓	✓	✓		✓	✓	✓	✓	✓	✓	✓	✓					✓		✓	✓	✓	✓	✓
Nand1In1		✓	✓	✓	✓		✓	✓	✓	✓	✓	✓	✓	✓					✓	✓		✓	✓	✓	✓
Nand1In2		✓	✓	✓	✓		✓	✓	✓	✓	✓	✓	✓	✓					✓	✓		✓	✓	✓	✓
TimestampReset	✓						✓	✓	✓	✓	✓	✓	✓	✓	✓	✓	✓	✓	✓	✓	✓	✓	✓		

## VideoProcessBypassMode

**Related Setting Items:** [ImagingControl](#)

The video process bypass mode is a function that bypasses internal video processing on the camera. To use this function, VideoProcessBypassMode must be set to On.

### Functions Unavailable in VideoProcessBypassMode

Gain[DigitalRed][DigitalBlue], BlackLevel, BalanceWhiteAuto, LUTMode, ColorTransformationControl, EdgeEnhancer, ColorEnhancer, ShadingControl, SequencerGainDigitalRed/Blue, SequencerLutEnable

## Calculate the Maximum Frame or Trigger Rate (Approximate)

**Related Setting Items:** [AcquisitionControl](#)

This section describes how to calculate the maximum frame rate or the maximum trigger rate (approximate). First, calculate the H Period, then calculate the minimum frame period based on the H Period value, and finally calculate the maximum frame rate (when in Continuous mode) or maximum trigger rate (when in Trigger mode).

### Notes:

- The frame rate calculated in this topic is an approximate value and may have a certain margin of error (approx.  $\pm 0.2\%$ ).
- The following conditions are applied:
  - GevSCPD = 0 (default)
  - NetworkThroughputSafetyMargin = 92% (default)
  - GevGVSPExtendedIDMode = Off (default)
- The Frame Rate Calculator, which calculates the maximum frame rate or trigger rate, is available for download from the product page on the JAI website ([www.jai.com](http://www.jai.com)).

## 1. Calculate the H Period

The H Period value can be calculated from the LineTime[clk] value, which is calculated using the IF\_LINETIME, SENSOR\_LINETIME, and VIDEO\_LINETIME values.

### IF\_LINETIME, SENSOR\_LINETIME, VIDEO\_LINETIME

#### A. IF\_LINETIME

First calculate SendTime from the Payload, PacketNum and Overhead values, then calculate IF\_Hperiod from SendTime, and finally calculate IF\_LINETIME from IF\_Hperiod.

1. Calculate **Payload[Byte]**.

$$\text{Payload[Byte]} = \text{Width}(*1) \times \text{Height}(*1) \times (\text{PixelSize} / 8)$$

**Width (\*1) and Height (\*1):** When using a [Binning Function](#) (FD2x2BinningMode, BinningHorizontal/Vertical), [Image Scaling Mode \(Xscale\)](#) or [Decimation Mode](#), enter the Width and Height values **"after"** configuring the settings.

**PixelFormat** value: Select the value from the table below based on your [PixelFormat](#) setting.

PixelFormat		PixelSize
Mono8	BayerRG8	8
Mono10, Mono12	BayerRG10, BayerRG12	16
Mono10Packed, Mono12Packed	BayerRG10Packed, BayerRG12Packed	12
-	RGB8	24
-	RGB10V1Packed, RGB10p32	32

2. Calculate **PacketNum** from the Payload value.

$$\text{PacketNum} = \text{Roundup}(\text{Payload[Byte]} / (\text{GevSCPSPacketSize} - 36) + 2, 0)$$

3. Calculate **Overhead[Byte]** from the PacketNum value.

$$\text{Overhead[Byte]} = 44 + (74 \times \text{PacketNum})$$

4. Calculate **SendTime[us]** from the Payload, PacketNum, and Overhead values.

$$\text{SendTime[us]} = \text{Rounddown}(\frac{((\text{Payload[Byte]} + \text{Overhead[Byte]}) \times 1000 / 575[\text{MB}]) + (\text{PacketNum} \times 32)}{1000}, 0)$$

5. Calculate **IF\_Hperiod[us]** from the SendTime value.

$$\text{IF\_Hperiod[us]} = \text{SendTime[us]} / (\text{Height}(*1) + 1)$$

**Height(\*1):** Enter the following value when using the [Binning Function Image Scaling Mode \(Xscale\)](#) or [Decimation Mode](#).

- When **BinningVertical** is set to **2** or **ImageScalingMode** is set to **On**, enter the Height value **"before"** configuring the Binning or Image Scaling Mode settings.
- When **FD2x2BinningMode** is turned **On**, or **DecimationVertical** is set to **2**, enter the Height value **"after"** configuring the FD2x2Binning or Decimation Mode settings.

6. Calculate **IF\_LINETIME[clk]** from the IF\_Hperiod value.

$$\text{IF\_LINETIME[clk]} = \text{Rounddown}(\text{IF\_Hperiod[us]} \times 74.25[\text{MHz}] + 1, 0)$$

## B. SENSOR\_LINETIME[clk]

$$\text{SENSOR\_LINETIME[clk]} = \text{HMAX}$$

Select the **HMAX** value from the table below based on the Sensor Operation, the [SensorDigitizationBits](#) setting, and your camera model.

Sensor Operation	Sensor Digitization Bits	GOX-5105		GOX-8105		GOX-12405		GOX-16205		GOX-20405		GOX-24505	
		Mono	Color	Mono	Color	Mono	Color	Mono	Color	Mono	Color	Mono	Color
Normal Mode	8Bit	270		270		344		447		375		447	
	10Bit	274		302		429		549		469		549	
	12Bit	408		408		511		655		557		655	
FD2x2BinningMode or DecimationMode	8Bit	135	270	135	270	183	270	230	290	199	290	230	290
	10Bit	142	284	158	284	222	284	285	302	245	302	285	302
	12Bit	204	408	204	408	264	408	339	418	287	418	339	418

## C. VIDEO\_LINETIME[clk]

$$\text{VIDEO\_LINETIME[clk]} = \text{Roundup}((\text{Width}(*1) / 4) + \text{LineInterval}) / 156.25 \times 74.25, 0) + 1$$

**Width(\*1):** Enter the following value when using a [Binning Function](#), [Image Scaling Mode \(Xscale\)](#) or [Decimation Mode](#).

- When **BinningHorizontal** is set to **2** or **ImageScalingMode** is set to **On**, enter the Width value "**before**" configuring the Binning or Image Scaling Mode settings.
- When **FD2x2BinningMode** is turned **On**, or **DecimationHorizontal** is set to **2**, enter the Width value "**after**" configuring the FD2x2Binning or Decimation Mode settings.

**LineInterval:** Select the LineInterval value from the table below based on the BinningHorizontal/Binning Vertical and ImageScalingMode settings.

BinningHorizontal	BinningVertical	ImageScalingMode	LineInterval
1	1	Off	4
2			8
1	2		
2			
1	1	On	

## LineTime[clk]

Next, calculate the LineTime[clk] value using the IF\_LINETIME, SENSOR\_LINETIME, and VIDEO\_LINETIME values.

$$\text{LineTime[clk]} = \text{MAX}( \text{IF\_LINETIME[clk]}, \text{SENSOR\_LINETIME[clk]}, \text{VIDEO\_LINETIME[clk]} )$$

## H Period

Finally, calculate the **H Period** based on the above LineTime[clk] value.

$$\text{H Period[us]} = \text{LineTime[clk]} / 74.25[\text{MHz}]$$

## 2. Calculate the Minimum Frame Period

Next, calculate the Minimum Frame Period value.

$$\text{Minimum Frame Period[us]} = \text{Round}( \text{H Period[us]} \times (\text{Height}(*1) + \text{VBlanking} + 2), 0 )$$

**Height(\*1):** Enter the following value when using the [Binning Function Image Scaling Mode \(Xscale\)](#) or [Decimation Mode](#).

- When **BinningVertical** is set to **2** or **ImageScalingMode** is set to **On**, enter the Height value "**before**" configuring the Binning or Image Scaling Mode settings.
- When **FD2x2BinningMode** is turned **On**, or **DecimationVertical** is set to **2**, enter the Height value "**after**" configuring the FD2x2Binning or Decimation Mode settings.

**VBlanking:** Select the **VBlanking** value from the table below based on the Sensor Operation, the [SensorDigitizationBits](#) setting, and your camera model.

Sensor Operation	Sensor DigitizationBits	GOX-5105		GOX-8105		GOX-12405		GOX-16205		GOX-20405		GOX-24505	
		Mono	Color	Mono	Color	Mono	Color	Mono	Color	Mono	Color	Mono	Color
Normal Mode	8Bit	172		172		152		118		124		118	
	10Bit	152		164		142		112		116		112	
	12Bit	144		144		130		110		112		110	
FD2x2BinningMode or DecimationMode	8Bit	258	172	258	172	214	172	144	132	152	132	144	132
	10Bit	246	166	234	166	190	166	136	130	144	130	136	130
	12Bit	202	144	202	144	174	144	128	120	136	120	128	120



### 3. Calculate the Maximum Frame Rate or Maximum Trigger Rate

Finally, calculate the maximum acquisition frame rate (when in Continuous Mode) or maximum trigger rate (when in Trigger Mode).

#### Maximum Acquisition Frame Rate (Continuous Mode: FrameStart Trigger = Off)

$$\text{Maximum Acquisition Frame Rate[Hz]} = 1000000 / \text{Minimum Frame Period[us]}$$

#### Maximum Trigger Rate (Trigger Mode: FrameStart Trigger = On)

First, calculate the Maximum Overlap Time value for the shortest trigger period.

$$\text{MaxOverlapTime\_TrOlr}[us] = \text{Minimum Frame Period[us]} - (\text{Non-ExposurePeriod[H]} \times \text{H Period[us]})$$

Select the **Non-ExposurePeriod[H]** value from the table below based on the Sensor Operation, the SensorDigitizationBits setting, and your camera model.

Sensor Operation	Sensor DigitizationBits	GOX-5105		GOX-8105		GOX-12405		GOX-16205		GOX-20405		GOX-24505	
		Mono	Color	Mono	Color	Mono	Color	Mono	Color	Mono	Color	Mono	Color
Normal Mode	8Bit	70		70		56		24		26		24	
	10Bit	66		64		48		20		22		20	
	12Bit	50		50		40		20		20		20	
FD2x2BinningMode or DecimationMode	8Bit	132	70	132	70	100	70	36	30	40	30	36	30
	10Bit	124	66	116	66	84	66	32	28	36	28	32	28
	12Bit	92	50	92	50	72	50	28	24	32	24	28	24

Next, calculate the Maximum Trigger Rate. The formula depends on whether the Exposure Time value is longer or shorter than the MaxOverlapTime\_TrOIRD value.

**A. When ExposureTime  $\leq$  MaxOverlapTime\_TrOIRD[us]**

$$\text{Maximum Trigger Rate[Hz]} = \text{Maximum Acquisition Frame Rate[Hz]}$$

**B. When ExposureTime > MaxOverlapTime\_TrOIRD[us]**

First, calculate the Non-OverlapExposureTime\_TrOIRD[us] value.

$$\text{Non-OverlapExposureTime_TrOIRD[us]} = \text{ExposureTime} - \text{MaxOverlapTime_TrOIRD[us]}$$

Finally, calculate the Maximum Trigger Rate.

$$\text{Maximum Trigger Rate[Hz]} = 1000000 / (\text{Minimum Frame Period[us]} + \text{Non-OverlapExposureTime_TrOIRD[us]})$$

## Timing Chart

---

### Related Setting Items: [AcquisitionControl](#)

This section shows the timing charts under the following conditions on each model when FrameStartTriger is set to **On**.

- [Exposure Mode = Timed \(Overlap Readout\)](#)
- [Exposure Mode = TriggerWidth \(Overlap Readout\)](#)
- [Exposure Mode = Timed \(RCT Mode\)](#)

### Notes:

- The values on the timing charts were measured with the following settings:
  - GevSCPSPacketSize: Max (12036Byte)
  - GevSCPD: Min(0)
  - GevGVSPExtendedIDMode: Off
  - NetworkThroughputSafetyMargin: 100%
- On this camera, the ExposureActive signal's pulse width includes the Exposure offset duration (2.45us). Therefore, "ExposureActive signal's pulse width = ExposureTime value (us) + 2.45(us)," or in the case of TriggerWidth operation "ExposureActive signal's pulse width = Trigger Signal's Effective Pulse Width (us) + 2.45(us)."

### Exposure Mode = Timed (Overlap Readout)

This section shows the timing charts when FrameStartTrigger is set to **On**, and ExposureMode is set to **Timed** (Overlap Readout).

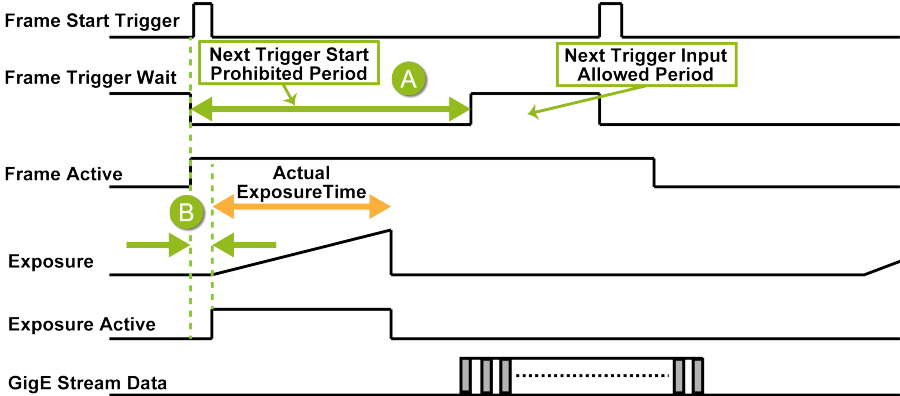

A	Frame Period (usec)
B	Period From Trigger Start Edge to Exposure Start (usec)

**GOX-5105M-5GE, GOX-5105C-5GE****■ Exposure Mode = Timed (Frame Start Trigger On, Overlap Readout)**

Pixel Format	Frame Period [A] usec	Period From Trigger Start Edge to Exposure Start [B] (usec)
<b>Full (Max Frame Rate)</b>		
Mono8	8850	52.5
Mono10, Mono12	17637	104.0
Mono10Packed, Mono12Packed	13245	78.2
BayerRG8	8850	52.5
BayerRG10, BayerRG12	17637	104.0
BayerRG10Packed, BayerRG12Packed	13245	78.2
RGB8	26455	155.6
RGB10V1Packed, RGB10p32	35336	207.3
<b>Binning Horizontal (Max Frame Rate)</b>		
Mono8	8905	52.9
Mono10, Mono12	8905	52.8
Mono10Packed, Mono12Packed	8905	52.9
<b>Binning Vertical (Max Frame Rate)</b>		
Mono8	8905	52.9
Mono10, Mono12	17637	104.0
Mono10Packed, Mono12Packed	13245	78.2
<b>Binning Horizontal &amp; Binning Vertical (Max Frame Rate)</b>		
Mono8	8905	52.8
Mono10, Mono12	8905	52.9
Mono10Packed, Mono12Packed	8905	52.9

**GOX-8105M-5GE, GOX-8105C-5GE****■ Exposure Mode = Timed (Frame Start Trigger On, Overlap Readout)**

Pixel Format	Frame Period [A] usec	Period From Trigger Start Edge to Exposure Start [B] (usec)
<b>Full (Max Frame Rate)</b>		
Mono8	13889	60.6
Mono10, Mono12	27701	120.1
Mono10Packed, Mono12Packed	20790	90.3
BayerRG8	13889	60.6
BayerRG10, BayerRG12	27701	120.1
BayerRG10Packed, BayerRG12Packed	20790	90.3
RGB8	41667	180.3
RGB10V1Packed, RGB10p32	55556	240.2
<b>Binning Horizontal (Max Frame Rate)</b>		
Mono8	13967	60.9
Mono10, Mono12	13967	60.9
Mono10Packed, Mono12Packed	13967	60.9
<b>Binning Vertical (Max Frame Rate)</b>		
Mono8	13967	60.9
Mono10, Mono12	27701	120.1
Mono10Packed, Mono12Packed	20790	90.3
<b>Binning Horizontal &amp; Binning Vertical (Max Frame Rate)</b>		
Mono8	13967	60.9
Mono10, Mono12	13967	60.9
Mono10Packed, Mono12Packed	13967	60.9

**GOX-12405M-5GE, GOX-12405C-5GE****■ Exposure Mode = Timed (Frame Start Trigger On, Overlap Readout)**

Pixel Format	Frame Period [A] usec	Period From Trigger Start Edge to Exposure Start [B] (usec)
<b>Full (Max Frame Rate)</b>		
Mono8	21053	74.0
Mono10, Mono12	42017	147.2
Mono10Packed, Mono12Packed	31546	110.6
BayerRG8	21053	74.0
BayerRG10, BayerRG12	42017	147.2
BayerRG10Packed, BayerRG12Packed	31546	110.6
RGB8	62945	220.4
RGB10V1Packed, RGB10p32	83910	293.6
<b>Binning Horizontal (Max Frame Rate)</b>		
Mono8	21142	74.3
Mono10, Mono12	21142	74.3
Mono10Packed, Mono12Packed	21142	74.3
<b>Binning Vertical (Max Frame Rate)</b>		
Mono8	21142	74.3
Mono10, Mono12	42017	147.0
Mono10Packed, Mono12Packed	31546	110.5
<b>Binning Horizontal &amp; Binning Vertical (Max Frame Rate)</b>		
Mono8	21142	74.3
Mono10, Mono12	21142	74.3
Mono10Packed, Mono12Packed	21142	74.3

**GOX-16205M-5GE, GOX-16205C-5GE****■ Exposure Mode = Timed (Frame Start Trigger On, Overlap Readout)**

Pixel Format	Frame Period [A] usec	Period From Trigger Start Edge to Exposure Start [B] (usec)
<b>Full (Max Frame Rate)</b>		
Mono8	27248	78.3
Mono10, Mono12	54348	155.8
Mono10Packed, Mono12Packed	40817	117.1
BayerRG8	27248	78.3
BayerRG10, BayerRG12	54348	155.8
BayerRG10Packed, BayerRG12Packed	40817	117.1
RGB8	81301	232.7
RGB10V1Packed, RGB10p32	108696	309.9
<b>Binning Horizontal (Max Frame Rate)</b>		
Mono8	27101	77.9
Mono10, Mono12	27174	78.1
Mono10Packed, Mono12Packed	27101	78.0
<b>Binning Vertical (Max Frame Rate)</b>		
Mono8	27248	78.3
Mono10, Mono12	54348	155.8
Mono10Packed, Mono12Packed	40817	117.0
<b>Binning Horizontal &amp; Binning Vertical (Max Frame Rate)</b>		
Mono8	27101	78.0
Mono10, Mono12	27174	78.1
Mono10Packed, Mono12Packed	27101	78.0



**GOX-20405M-5GE, GOX-20405C-5GE****■ Exposure Mode = Timed (Frame Start Trigger On, Overlap Readout)**

Pixel Format	Frame Period [A] usec	Period From Trigger Start Edge to Exposure Start [B] (usec)
<b>Full (Max Frame Rate)</b>		
Mono8	33784	66.3
Mono10, Mono12	67568	131.8
Mono10Packed, Mono12Packed	50762	99.0
BayerRG8	33784	66.3
BayerRG10, BayerRG12	67568	131.8
BayerRG10Packed, BayerRG12Packed	50762	99.0
RGB8	101074	197.2
RGB10V1Packed, RGB10p32	135300	262.7
<b>Binning Horizontal (Max Frame Rate)</b>		
Mono8	33899	66.4
Mono10, Mono12	33899	66.4
Mono10Packed, Mono12Packed	33899	66.4
<b>Binning Vertical (Max Frame Rate)</b>		
Mono8	33899	66.4
Mono10, Mono12	67568	131.7
Mono10Packed, Mono12Packed	50762	98.9
<b>Binning Horizontal &amp; Binning Vertical (Max Frame Rate)</b>		
Mono8	33899	66.4
Mono10, Mono12	33899	66.4
Mono10Packed, Mono12Packed	33899	66.4

## GOX-24505M-5GE, GOX-24505C-5GE

### ■ Exposure Mode = Timed (Frame Start Trigger On, Overlap Readout)

Pixel Format	Frame Period [A] usec	Period From Trigger Start Edge to Exposure Start [B] (usec)
<b>Full (Max Frame Rate)</b>		
Mono8	40651	78.1
Mono10, Mono12	81302	155.4
Mono10Packed, Mono12Packed	60976	116.7
BayerRG8	40651	78.1
BayerRG10, BayerRG12	81302	155.4
BayerRG10Packed, BayerRG12Packed	60976	116.7
RGB8	121952	232.7
RGB10V1Packed, RGB10p32	163936	310.1
<b>Binning Horizontal (Max Frame Rate)</b>		
Mono8	40651	78.0
Mono10, Mono12	40651	77.9
Mono10Packed, Mono12Packed	40651	78.0
<b>Binning Vertical (Max Frame Rate)</b>		
Mono8	40651	78.2
Mono10, Mono12	81301	155.4
Mono10Packed, Mono12Packed	60976	116.7
<b>Binning Horizontal &amp; Binning Vertical (Max Frame Rate)</b>		
Mono8	40651	78.0
Mono10, Mono12	40651	78.0
Mono10Packed, Mono12Packed	40651	78.0

### Exposure Mode = TriggerWidth (Overlap Readout)

This section shows the timing charts when FrameStartTrigger is set to **On**, and ExposureMode is set to **TriggerWidth** (Overlap Readout).

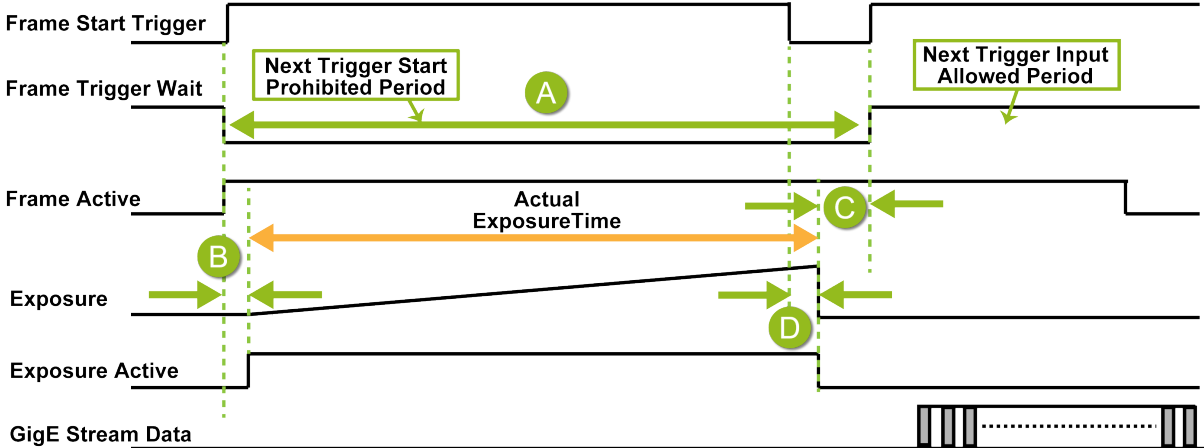

<b>A</b>	Frame Period (usec)
<b>B</b>	Period From Trigger Start Edge to Exposure Start (usec)
<b>C</b>	Period From Exposure End to Next Trigger Start (usec)
<b>D</b>	Period From Trigger End to Exposure End (usec) (= B + 2.45 usec)

**GOX-5105M-5GE, GOX-5105C-5GE****■ Exposure Mode = TriggerWidth (Frame Start Trigger On, Overlap Readout)**

Pixel Format	Frame Period [A] (usec)	Period From Trigger Start Edge to Exposure Start [B] (usec)	Period from Exposure End to Next Trigger Start [C] (usec)
<b>Full (Max Frame Rate), Maximum Exposure Time in Max Frame Rate</b>			
Mono8	9001	52.5	197.0
Mono10, Mono12	17954	104.0	396.2
Mono10Packed, Mono12Packed	13387	78.2	296.0
BayerRG8	9001	52.5	197.0
BayerRG10, BayerRG12	17954	104.0	396.2
BayerRG10Packed, BayerRG12Packed	13387	78.2	296.0
RGB8	26362	156.1	595.5
RGB10V1Packed, RGB10p32	35305	207.9	794.6
<b>Binning Horizontal (Max Frame Rate), Maximum Exposure Time in Max Frame Rate</b>			
Mono8	9001	52.8	197.9
Mono10, Mono12	9001	52.8	198.6
Mono10Packed, Mono12Packed	9001	52.8	198.6
<b>Binning Vertical (Max Frame Rate), Maximum Exposure Time in Max Frame Rate</b>			
Mono8	8977	52.8	197.9
Mono10, Mono12	17857	104.0	396.2
Mono10Packed, Mono12Packed	13405	78.2	296.0
<b>Binning Horizontal &amp; Binning Vertical (Max Frame Rate), Maximum Exposure Time in Max Frame Rate</b>			
Mono8	8993	52.8	197.9
Mono10, Mono12	9001	52.8	198.6
Mono10Packed, Mono12Packed	8993	52.8	198.6

**GOX-8105M-5GE, GOX-8105C-5GE****Exposure Mode = TriggerWidth (Frame Start Trigger On, Overlap Readout)**

Pixel Format	Frame Period [A] (usec)	Period From Trigger Start Edge to Exposure Start [B] (usec)	Period from Exposure End to Next Trigger Start [C] (usec)
<b>Full (Max Frame Rate), Maximum Exposure Time in Max Frame Rate</b>			
Mono8	13901	60.7	219.8
Mono10, Mono12	27677	120.4	440.2
Mono10Packed, Mono12Packed	20770	90.4	329.1
BayerRG8	13901	60.7	219.8
BayerRG10, BayerRG12	27677	120.4	440.2
BayerRG10Packed, BayerRG12Packed	20770	90.4	329.1
RGB8	42000	180.3	661.4
RGB10V1Packed, RGB10p32	55095	240.2	880.9
<b>Binning Horizontal (Max Frame Rate), Maximum Exposure Time in Max Frame Rate</b>			
Mono8	13976	61	219.5
Mono10, Mono12	13977	61	220.5
Mono10Packed, Mono12Packed	13977	61	221.0
<b>Binning Vertical (Max Frame Rate), Maximum Exposure Time in Max Frame Rate</b>			
Mono8	13981	61.0	219.8
Mono10, Mono12	27587	120.3	440.2
Mono10Packed, Mono12Packed	20762	90.4	329.1
<b>Binning Horizontal &amp; Binning Vertical (Max Frame Rate), Maximum Exposure Time in Max Frame Rate</b>			
Mono8	13979	61.0	219.8
Mono10, Mono12	13977	61.0	220.5
Mono10Packed, Mono12Packed	13986	61.0	221.0

**GOX-12405M-5GE, GOX-12405C-5GE****■ Exposure Mode = TriggerWidth (Frame Start Trigger On, Overlap Readout)**

Pixel Format	Frame Period [A] (usec)	Period From Trigger Start Edge to Exposure Start [B] (usec)	Period from Exposure End to Next Trigger Start [C] (usec)
<b>Full (Max Frame Rate), Maximum Exposure Time in Max Frame Rate</b>			
Mono8	21009	74.0	224.5
Mono10, Mono12	44643	147.2	450.4
Mono10Packed, Mono12Packed	32574	110.6	337.2
BayerRG8	21009	74.0	224.5
BayerRG10, BayerRG12	44643	147.2	450.4
BayerRG10Packed, BayerRG12Packed	32574	110.6	337.2
RGB8	66667	220.4	677.3
RGB10V1Packed, RGB10p32	83279	293.4	903.1
<b>Binning Horizontal (Max Frame Rate), Maximum Exposure Time in Max Frame Rate</b>			
Mono8	21009	74.2	225.3
Mono10, Mono12	21009	74.2	225.3
Mono10Packed, Mono12Packed	21009	74.2	225.3
<b>Binning Vertical (Max Frame Rate), Maximum Exposure Time in Max Frame Rate</b>			
Mono8	21009	74.2	224.3
Mono10, Mono12	43290	147.0	450.0
Mono10Packed, Mono12Packed	31949	110.4	337.0
<b>Binning Horizontal &amp; Binning Vertical (Max Frame Rate), Maximum Exposure Time in Max Frame Rate</b>			
Mono8	21009	74.2	225.3
Mono10, Mono12	21009	74.2	225.3
Mono10Packed, Mono12Packed	21009	74.2	225.3

**GOX-16205M-5GE, GOX-16205C-5GE****Exposure Mode = TriggerWidth (Frame Start Trigger On, Overlap Readout)**

Pixel Format	Frame Period [A] (usec)	Period From Trigger Start Edge to Exposure Start [B] (usec)	Period from Exposure End to Next Trigger Start [C] (usec)
<b>Full (Max Frame Rate), Maximum Exposure Time in Max Frame Rate</b>			
Mono8	27027	78.2	69.1
Mono10, Mono12	59172	155.7	137.7
Mono10Packed, Mono12Packed	42017	116.7	137.8
BayerRG8	27027	78.2	69.1
BayerRG10, BayerRG12	59172	155.7	137.7
BayerRG10Packed, BayerRG12Packed	42017	116.7	137.8
RGB8	87720	232.7	205.0
RGB10V1Packed, RGB10p32	109891	309.9	272.7
<b>Binning Horizontal (Max Frame Rate), Maximum Exposure Time in Max Frame Rate</b>			
Mono8	27027	77.9	69.0
Mono10, Mono12	27027	77.9	68.8
Mono10Packed, Mono12Packed	27027	77.9	68.9
<b>Binning Vertical (Max Frame Rate), Maximum Exposure Time in Max Frame Rate</b>			
Mono8	27027	78.2	69.0
Mono10, Mono12	59172	155.7	137.5
Mono10Packed, Mono12Packed	42194	116.7	103.5
<b>Binning Horizontal &amp; Binning Vertical (Max Frame Rate), Maximum Exposure Time in Max Frame Rate</b>			
Mono8	27027	77.9	69.0
Mono10, Mono12	27027	77.9	68.8
Mono10Packed, Mono12Packed	26975	78.1	66.8

**GOX-20405M-5GE, GOX-20405C-5GE****Exposure Mode = TriggerWidth (Frame Start Trigger On, Overlap Readout)**

Pixel Format	Frame Period [A] (usec)	Period From Trigger Start Edge to Exposure Start [B] (usec)	Period from Exposure End to Next Trigger Start [C] (usec)
<b>Full (Max Frame Rate), Maximum Exposure Time in Max Frame Rate</b>			
Mono8	35461	66.3	70.3
Mono10, Mono12	69931	131.7	142.9
Mono10Packed, Mono12Packed	54645	99.0	106.6
BayerRG8	35461	66.3	70.3
BayerRG10, BayerRG12	69931	131.7	142.9
BayerRG10Packed, BayerRG12Packed	54645	99.0	106.6
RGB8	100553	196.8	216.4
RGB10V1Packed, RGB10p32	138764	262.7	288.9
<b>Binning Horizontal (Max Frame Rate), Maximum Exposure Time in Max Frame Rate</b>			
Mono8	35336	66.4	70.3
Mono10, Mono12	35336	66.4	70.2
Mono10Packed, Mono12Packed	35336	66.4	70.2
<b>Binning Vertical (Max Frame Rate), Maximum Exposure Time in Max Frame Rate</b>			
Mono8	35461	66.4	70.3
Mono10, Mono12	69931	131.6	142.9
Mono10Packed, Mono12Packed	54055	98.9	106.6
<b>Binning Horizontal &amp; Binning Vertical (Max Frame Rate), Maximum Exposure Time in Max Frame Rate</b>			
Mono8	35336	66.4	70.3
Mono10, Mono12	35461	66.4	70.2
Mono10Packed, Mono12Packed	35461	66.4	70.2



**GOX-24505M-5GE, GOX-24505C-5GE****Exposure Mode = TriggerWidth (Frame Start Trigger On, Overlap Readout)**

Pixel Format	Frame Period [A] (usec)	Period From Trigger Start Edge to Exposure Start [B] (usec)	Period from Exposure End to Next Trigger Start [C] (usec)
<b>Full (Max Frame Rate), Maximum Exposure Time in Max Frame Rate</b>			
Mono8	40505	77.9	67.6
Mono10, Mono12	80783	155.2	135.1
Mono10Packed, Mono12Packed	60902	116.7	100.9
BayerRG8	40505	77.9	67.6
BayerRG10, BayerRG12	80783	155.2	135.1
BayerRG10Packed, BayerRG12Packed	60902	116.7	100.9
RGB8	121370	232.4	203.8
RGB10V1Packed, RGB10p32	161620	309.6	272.6
<b>Binning Horizontal (Max Frame Rate), Maximum Exposure Time in Max Frame Rate</b>			
Mono8	40569	78.1	66.4
Mono10, Mono12	40573	78.1	66.4
Mono10Packed, Mono12Packed	40590	78.1	66.4
<b>Binning Vertical (Max Frame Rate), Maximum Exposure Time in Max Frame Rate</b>			
Mono8	40569	78.1	66.5
Mono10, Mono12	80794	155.2	135.1
Mono10Packed, Mono12Packed	60621	116.6	100.9
<b>Binning Horizontal &amp; Binning Vertical (Max Frame Rate), Maximum Exposure Time in Max Frame Rate</b>			
Mono8	40568	78.1	66.7
Mono10, Mono12	40573	78.1	66.4
Mono10Packed, Mono12Packed	40582	78.1	66.4

### Exposure Mode = Timed (RCT Mode)

This section shows the timing charts when FrameStartTrigger is set to **On**, and ExposureMode is set to **Timed** (RCT Mode).

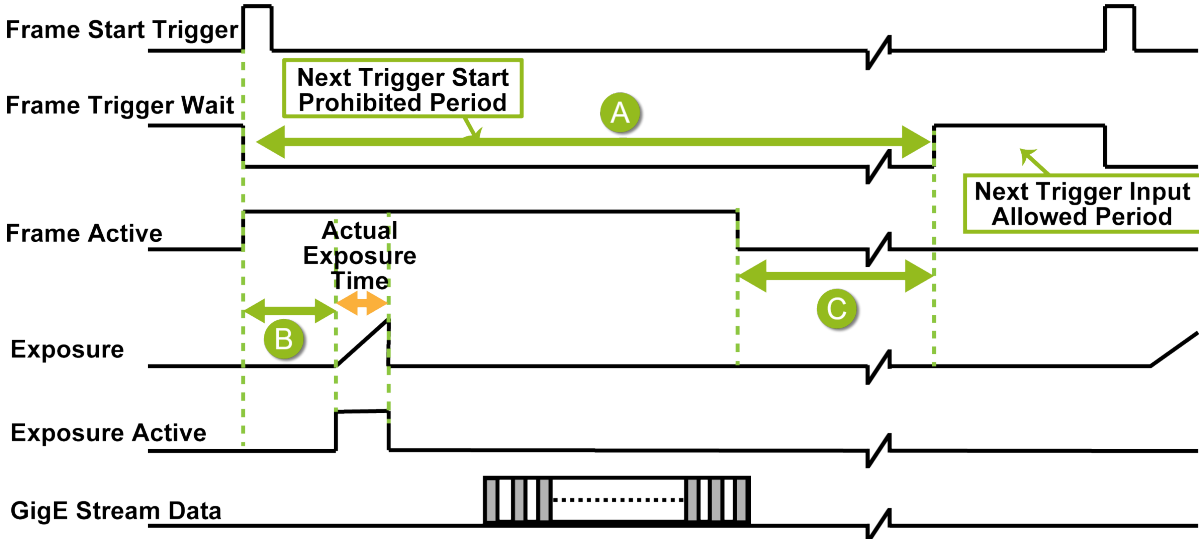

<b>A</b>	Frame Period (usec)
<b>B</b>	Period From Trigger Start Edge to Exposure Start (usec)
<b>C</b>	Data Invalid Period (usec)

**GOX-5105M-5GE, GOX-5105C-5GE****Exposure Mode = Timed (Frame Start Trigger On, RCT Mode)**

Pixel Format	Frame Period [A] (usec)	Period From Trigger Start Edge to Exposure Start [B] (usec)	Data Invalid Period [C] (usec)
<b>Full (Max Frame Rate), Exposure Time Minimum</b>			
Mono8	103093	1817.8	92536
Mono10, Mono12	103094	1869.3	83821
Mono10Packed, Mono12Packed	103094	1843.5	88179
BayerRG8	103093	1817.8	92536
BayerRG10, BayerRG12	103094	1869.3	83821
BayerRG10Packed, BayerRG12Packed	103094	1843.5	88179
RGB8	103093	1920.9	75032
RGB10V1Packed, RGB10p32	103093	1972.6	66275
<b>Binning Horizontal (Max Frame Rate), Exposure Time Minimum</b>			
Mono8	103094	1818.1	92471
Mono10, Mono12	103094	1818.1	92471
Mono10Packed, Mono12Packed	103094	1818.1	92471
<b>Binning Vertical (Max Frame Rate), Exposure Time Minimum</b>			
Mono8	103093	1818.1	92473
Mono10, Mono12	103094	1869.2	83817
Mono10Packed, Mono12Packed	103094	1843.5	88175
<b>Binning Horizontal &amp; Binning Vertical (Max Frame Rate), Exposure Time Minimum</b>			
Mono8	103094	1818.1	92467
Mono10, Mono12	103094	1818.1	92467
Mono10Packed, Mono12Packed	103094	1818.1	92467

**GOX-8105M-5GE, GOX-8105C-5GE****Exposure Mode = Timed (Frame Start Trigger On, RCT Mode)**

Pixel Format	Frame Period [A] (usec)	Period From Trigger Start Edge to Exposure Start [B] (usec)	Data Invalid Period [C] (usec)
<b>Full (Max Frame Rate), Exposure Time Minimum</b>			
Mono8	103094	1825.8	87568
Mono10, Mono12	103094	1885.4	73909
Mono10Packed, Mono12Packed	103094	1855.6	80738
BayerRG8	103094	1825.8	87568
BayerRG10, BayerRG12	103094	1885.4	73909
BayerRG10Packed, BayerRG12Packed	103094	1855.6	80738
RGB8	103093	1945.6	60037
RGB10V1Packed, RGB10p32	104167	2005.5	47357
<b>Binning Horizontal (Max Frame Rate), Exposure Time Minimum</b>			
Mono8	103094	1826.2	87481
Mono10, Mono12	103094	1826.2	87481
Mono10Packed, Mono12Packed	103094	1826.2	87481
<b>Binning Vertical (Max Frame Rate), Exposure Time Minimum</b>			
Mono8	103094	1826.2	87483
Mono10, Mono12	103094	1885.4	73904
Mono10Packed, Mono12Packed	103094	1855.6	80734
<b>Binning Horizontal &amp; Binning Vertical (Max Frame Rate), Exposure Time Minimum</b>			
Mono8	103094	1826.2	87476
Mono10, Mono12	103094	1826.2	87476
Mono10Packed, Mono12Packed	103094	1826.2	87476

**GOX-12405M-5GE, GOX-12405C-5GE****Exposure Mode = Timed (Frame Start Trigger On, RCT Mode)**

Pixel Format	Frame Period [A] (usec)	Period From Trigger Start Edge to Exposure Start [B] (usec)	Data Invalid Period [C] (usec)
<b>Full (Max Frame Rate), Exposure Time Minimum</b>			
Mono8	103093	1839.2	80453
Mono10, Mono12	103093	1912.4	59649
Mono10Packed, Mono12Packed	103093	1875.9	70051
BayerRG8	103093	1839.2	80453
BayerRG10, BayerRG12	103093	1912.4	59649
BayerRG10Packed, BayerRG12Packed	103093	1875.9	70051
RGB8	102934	1985.6	38611
RGB10V1Packed, RGB10p32	103267	2058.8	18120
<b>Binning Horizontal (Max Frame Rate), Exposure Time Minimum</b>			
Mono8	103093	1839.6	80359
Mono10, Mono12	103093	1839.6	80359
Mono10Packed, Mono12Packed	103093	1839.6	80359
<b>Binning Vertical (Max Frame Rate), Exposure Time Minimum</b>			
Mono8	103093	1839.6	80362
Mono10, Mono12	103093	1912.3	59684
Mono10Packed, Mono12Packed	103093	1875.7	70086
<b>Binning Horizontal &amp; Binning Vertical (Max Frame Rate), Exposure Time Minimum</b>			
Mono8	103093	1839.6	80352
Mono10, Mono12	103093	1839.6	80352
Mono10Packed, Mono12Packed	103093	1839.6	80352

**GOX-16205M-5GE, GOX-16205C-5GE****Exposure Mode = Timed (Frame Start Trigger On, RCT Mode)**

Pixel Format	Frame Period [A] (usec)	Period From Trigger Start Edge to Exposure Start [B] (usec)	Data Invalid Period [C] (usec)
<b>Full (Max Frame Rate), Exposure Time Minimum</b>			
Mono8	102015	1843.4	73310
Mono10, Mono12	103093	1920.7	47485
Mono10Packed, Mono12Packed	103094	1882	60937
BayerRG8	102015	1843.4	73310
BayerRG10, BayerRG12	103093	1920.7	47485
BayerRG10Packed, BayerRG12Packed	103094	1882.0	60937
RGB8	103094	1998.0	20487
RGB10V1Packed, RGB10p32	111112	2075.2	1618
<b>Binning Horizontal (Max Frame Rate), Exposure Time Minimum</b>			
Mono8	102042	1843.2	73367
Mono10, Mono12	102042	1843.2	73367
Mono10Packed, Mono12Packed	102042	1843.2	73367
<b>Binning Vertical (Max Frame Rate), Exposure Time Minimum</b>			
Mono8	102042	1843.4	73287
Mono10, Mono12	103094	1920.6	47519
Mono10Packed, Mono12Packed	103094	1882.0	60929
<b>Binning Horizontal &amp; Binning Vertical (Max Frame Rate), Exposure Time Minimum</b>			
Mono8	102042	1843.2	73358
Mono10, Mono12	102042	1843.2	73358
Mono10Packed, Mono12Packed	102042	1843.2	73358

**GOX-20405M-5GE, GOX-20405C-5GE****Exposure Mode = Timed (Frame Start Trigger On, RCT Mode)**

Pixel Format	Frame Period [A] (usec)	Period From Trigger Start Edge to Exposure Start [B] (usec)	Data Invalid Period [C] (usec)
<b>Full (Max Frame Rate), Exposure Time Minimum</b>			
Mono8	102042	1831.6	66693
Mono10, Mono12	103094	1897.0	34253
Mono10Packed, Mono12Packed	103094	1864.3	50999
BayerRG8	102042	1831.6	66693
BayerRG10, BayerRG12	103094	1897.0	34253
BayerRG10Packed, BayerRG12Packed	103094	1864.3	50999
RGB8	102833	1962.5	422
RGB10V1Packed, RGB10p32	136504	2028.0	579
<b>Binning Horizontal (Max Frame Rate), Exposure Time Minimum</b>			
Mono8	102042	1831.7	66620
Mono10, Mono12	102041	1831.7	66620
Mono10Packed, Mono12Packed	102042	1831.7	66620
<b>Binning Vertical (Max Frame Rate), Exposure Time Minimum</b>			
Mono8	102042	1831.7	66624
Mono10, Mono12	103094	1896.9	34308
Mono10Packed, Mono12Packed	103094	1864.2	51054
<b>Binning Horizontal &amp; Binning Vertical (Max Frame Rate), Exposure Time Minimum</b>			
Mono8	102042	1831.7	66613
Mono10, Mono12	102042	1831.7	66613
Mono10Packed, Mono12Packed	102042	1831.7	66613

**GOX-24505M-5GE, GOX-24505C-5GE****Exposure Mode = Timed (Frame Start Trigger On, RCT Mode)**

Pixel Format	Frame Period [A] (usec)	Period From Trigger Start Edge to Exposure Start [B] (usec)	Data Invalid Period [C] (usec)
<b>Full (Max Frame Rate), Exposure Time Minimum</b>			
Mono8	102042	1843.4	59864
Mono10, Mono12	103094	1920.7	20539
Mono10Packed, Mono12Packed	103094	1882.0	40728
BayerRG8	102042	1843.4	59864
BayerRG10, BayerRG12	103094	1920.7	20539
BayerRG10Packed, BayerRG12Packed	103094	1882.0	40728
RGB8	125001	1998.0	1975
RGB10V1Packed, RGB10p32	166668	2075.4	3240
<b>Binning Horizontal (Max Frame Rate), Exposure Time Minimum</b>			
Mono8	102042	1843.2	59915
Mono10, Mono12	102042	1843.2	59915
Mono10Packed, Mono12Packed	102042	1843.2	59915
<b>Binning Vertical (Max Frame Rate), Exposure Time Minimum</b>			
Mono8	102042	1843.5	59792
Mono10, Mono12	103094	1920.7	20531
Mono10Packed, Mono12Packed	103094	1882.0	40719
<b>Binning Horizontal &amp; Binning Vertical (Max Frame Rate), Exposure Time Minimum</b>			
Mono8	102042	1843.2	59906
Mono10, Mono12	102042	1843.2	59906
Mono10Packed, Mono12Packed	102042	1843.2	59906



## Gain Control

Related Setting Items: [AnalogControl](#)

Adjust the overall gain with AnalogAll (master gain), and adjust the white balance by changing DigitalRed and DigitalBlue.

### Color Model

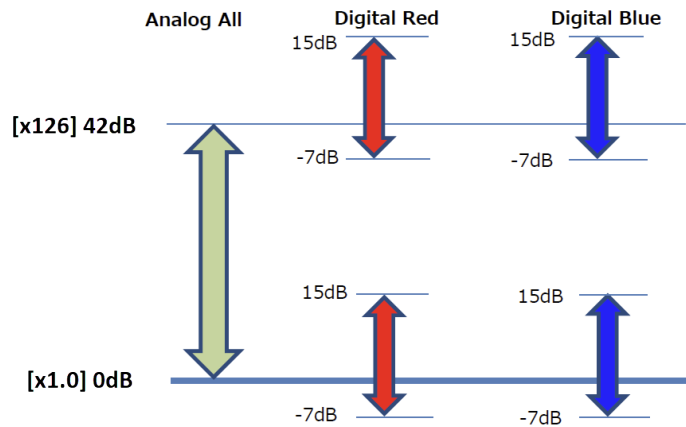

### Monochrome Model

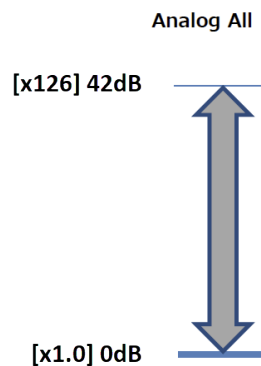

## Automatic Gain Level Control

Set GainAuto to **Continuous** to control the gain level automatically.

When GainAuto is set to **Continuous**, you can configure the conditions for automatic adjustment in detail.

- When GainAuto is set to **Continuous**, the automatic adjustment will be performed continuously.
- When GainAuto is set to **Once**, the automatic adjustment will be performed only once.

# White Balance

**Related Setting Items:** [AnalogControl](#)

To adjust the white balance automatically, set BalanceWhiteAuto to **Once** (automatic adjustment only once) or **Continuous** (automatic adjustment always).

The metering area can be limited for automatic adjustment. To limit the metering area, specify each of the 16 areas with AWBAreaSelector and set AWBAreaEnable to True or False.

## 16 Areas

HighLeft	HighMidLeft	HighMidRight	HighRight
MidHighLeft	MidHighMidLeft	MidHighMidRight	MidHighRight
MidLowLeft	MidLowMidLeft	MidLowMidRight	MidLowRight
LowLeft	LowMidLeft	LowMidRight	LowRight

In addition, the white balance has been adjusted in advance for specific color temperature lighting. It is possible to select from the following four presets. (Color temperature for preset : 3200K, 5000K, 6500K, 7500K)

## Color Temperature

The adjustable range of white balance for this camera is 3000K to 9000K.

Please refer to the figure below for an overview of the relationship between various lighting types and color temperature.

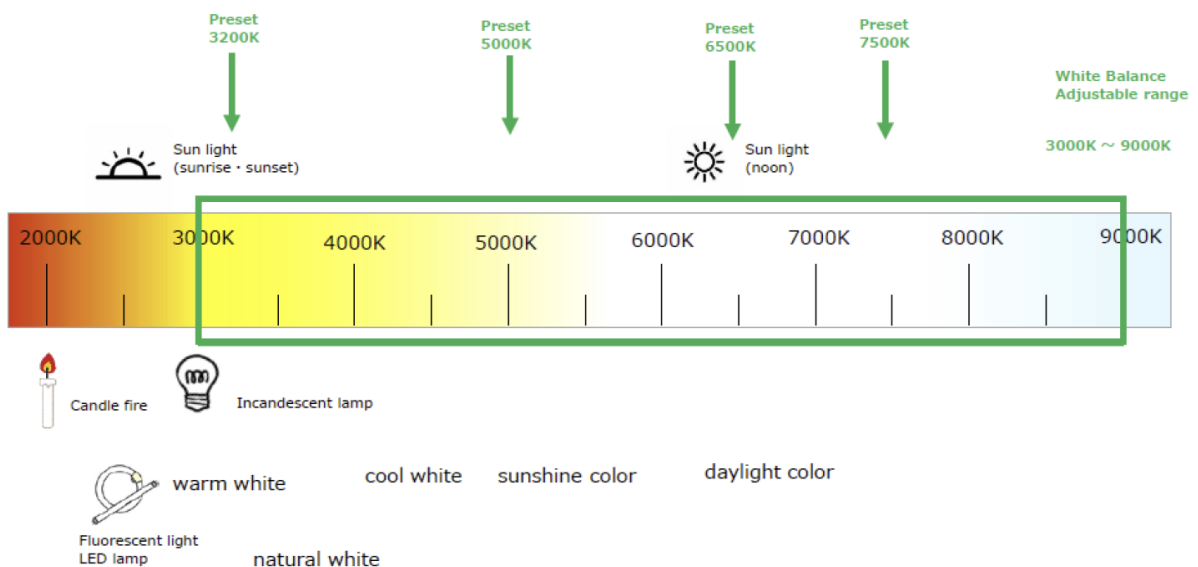

## ALC (Automatic Level Control) Function

Related Setting Items: [AutoLevelControl](#)

The ALC (automatic level control) function combines the automatic gain control (AGC/Auto Gain Control) and automatic exposure control (ASC/Auto Shutter Control) functions and is capable of handling various changes in brightness. The function operates as follows in response to changes in brightness.

Change from bright to dark: ASC → AGC

Change from dark to bright: AGC → ASC

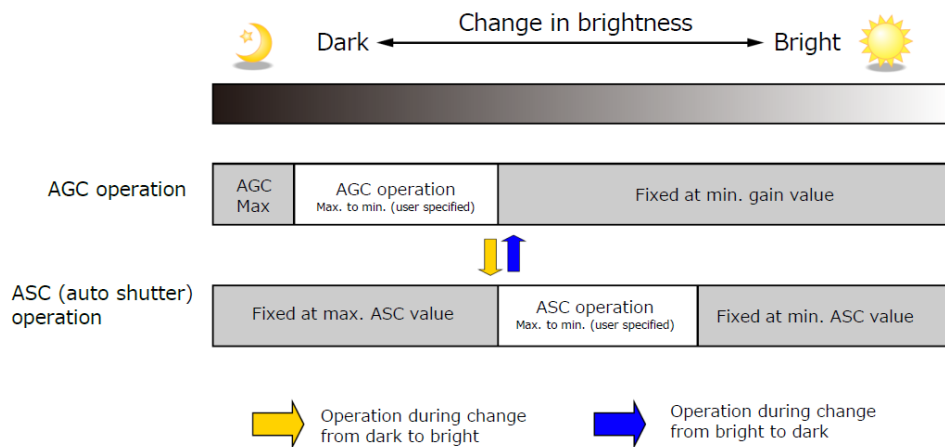

### To Use the ALC Function

Set GainAuto or ExposureAuto or both to **Continuous** mode. Configure the minimum value, maximum value, etc. for AGC and ASC in AutoLevelControl.

The target video levels for AGC and ASC are configured in ALCCReference. For example, when ALCCReference is set to 95%, video levels will be maintained at 95% using AGC and ASC.

In color models, the channel to be used as the reference for ALC control can be set.

- **ALCCControlReference:** Set whether to specify the SelectedChannel refer to channel (R, G, B) or PeakChannel refer to the channel with the highest average image level.
- If ALCCControlReference= SelectedChannel, set ALCCControlChannel to **Red**, **Green** or **Blue**.

The speed of ALC control can be set from 1 to 100 (fastest) in ALCCControlRatio.

**Note:** If the ALCCControlRatio setting is large, the ALC operation may cause hunting depending on the AcquisitionFrameRate setting. In this case, lower the value of AcquisitionFrameRate or ALCCControlRatio.

## Gamma Function

Related Setting Items: [AnalogControl](#)

The Gamma function corrects the output signals from the camera beforehand (reverse correction), taking into consideration the light-emitting properties of the monitor display. As the light-emitting properties of the monitor are not linear, the entire image may be darker or the gradation in the dark areas may be less noticeable when camera outputs are displayed without processing.

The Gamma function can be used to correct the camera signals with an opposite-direction curve and produce a display that is close to linear.

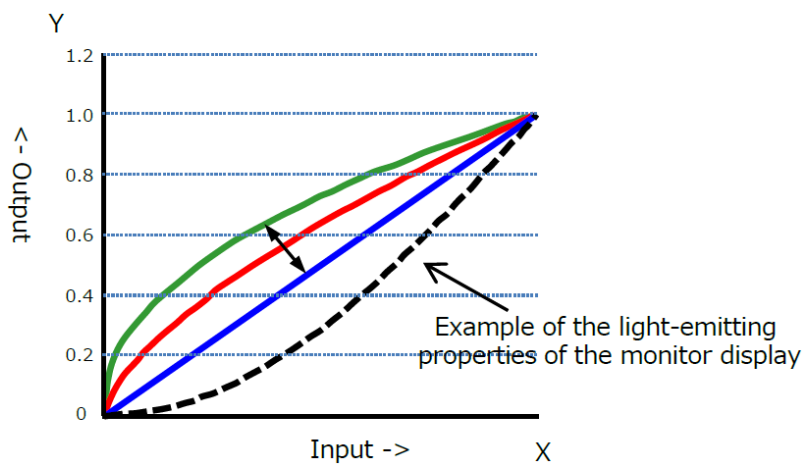

### To Use the Gamma Function

Configure the settings as follows.

Item	Setting Value / Selectable Range	Description
Gamma	0.45, 0.5, 0.55, 0.6, 0.65, 0.75, 0.8, 0.9, 1.0	Select the Gamma correction value.
LUTMode	Gamma	Use Gamma.

**Note:** You can use the LUT function to configure a curve with more detailed points. For details, see [LUT \(Lookup Table\)](#).

# LUT (Lookup Table)

**Related Setting Items:** [LUTControl](#)

The LUT function is used to generate a non-linear mapping between signal values captured on the sensor and those that are output from the camera. You can specify the output curve using 257 setting points (indexes).

## To Use the LUT Function

Configure the settings as follows.

Item	Setting Value / Selectable Range	Description
LUTSelector	Red, Green, Blue	Select the LUT channel to control (Color models only).
LUTIndex	0 ~ 256	Select the LUT index to configure. Indexes represent the possible pixel values captured on the sensor, from the lowest value (Index 0) to the highest (Index 256).  For example, Index 0 represents a full black pixel and Index 256 represents a full white pixel.
LUTValue	0 ~ 4095	Set the LUT output value for the selected index.

## LUT Value

LUT values range from 0 at the lowest to 4095 at the highest. Linear interpolation is used to calculate LUT values between the index points.

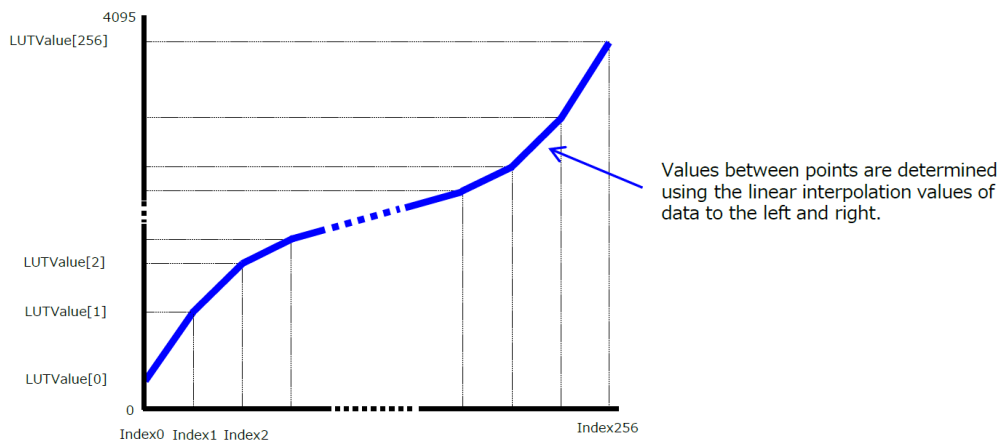

## BlemishCompensation

**Related Setting Items:** [BlemishControl](#)

Multiple defective pixels that are not adjacent to each other can occur on CMOS sensor cameras.

This camera features a function that interpolates defective pixels using the surrounding pixels. Up to 2000 pixels can be corrected. Pixel interpolation can be performed via automatic detection or point-by-point manual settings.

### Automatic Detection

Automatic detection can only detect lit defective pixels (i.e., white blemishes).

1. Shield the camera sensor. If a lens is attached, use the lens cap as a shield, for example.
2. Configure the threshold level for defective pixel detection with **BlemishDetectThreshold**.
  - Up to 2000 pixels can be corrected.
  - The threshold value is specified as a percentage.
  - The default setting is "10" with 10% of the full scale (100%) specified as the threshold value.
3. Execute **BlemishDetect** to start automatic detection. After detection, the interpolation data is saved to the camera's internal memory.

### **To check the number of interpolated pixels after automatic detection**

You can check the number of pixels interpolated via automatic detection by loading the BlemishNum data.

#### **Notes:**

Automatic detection will not be executed when:

- No image is being output.
- TestPattern is being output
- In Sequencer Mode ([Sequencer Function](#))
- In MultiRoi mode ([ROI Function \(Multi ROI\)](#))
- The image is not full ROI size ([ROI Function \(Single ROI\)](#))
- In Reverse mode ([Image Flip Function](#))
- GradationCompressionMode is not Off ([Gradation Compression Mode](#))
- AcquisitionMode is not Continuous ([Acquisition Control](#))
- Not in lens cap state

## Manual Configuration

1. Select the **index** in **BlemishCompensationIndex**. You can select from 1 to 2000. However, configure the indexes in order starting with the smallest index. If you skip indexes while configuring settings, interpolation may not be performed.
2. Specify the pixel points for interpolation using the **BlemishCompensationPositionX** and **BlemishCompensationPositionY** settings.

### Notes:

- You can configure values that are within the total effective pixel area. Specify pixels for which interpolation is not necessary as -1. If 0 is specified, the first line or first pixel will be interpolated.
- To delete the configured pixel points, execute **BlemishCompensationDataClear** with the corresponding index selected.

3. Execute **BlemishStore**. Blemish compensation data will be stored.
4. Set BlemishEnable to **Enable**, and execute interpolation. If it is set to **Disable all**, all interpolation for defective pixels will be disabled (including the factory-set interpolation data). If set to **Disable user detection**, the factory-set interpolation data remains valid, and only the interpolation data registered in **BlemishCompensationIndex** is disabled.

## Shading Correction

**Related Setting Items:** [ShadingControl](#)

The ShadingCorrection function corrects non-uniformity (i.e., shading) in the amount of light generated by the lens and lighting equipment. Using this function allows correction even if top, bottom, left, and right shading is not symmetrical in relation to the center of the screen (H, V).

This function can be used even when the effective image area is limited (an area with both Width and Height set to more than 512 must be configured) by the [ROI Function \(Single ROI\)](#). In such cases, the correction area is included in the image area configured by the ROI.

Block size is 128 × 128 pixels.

The following shading correction modes are available on the camera.

### ■ FlatShading (Monochrome model, Color model)

Correction is performed using the area of the screen with the highest brightness level as the reference and adjusting the brightness levels of the other areas to match this level.

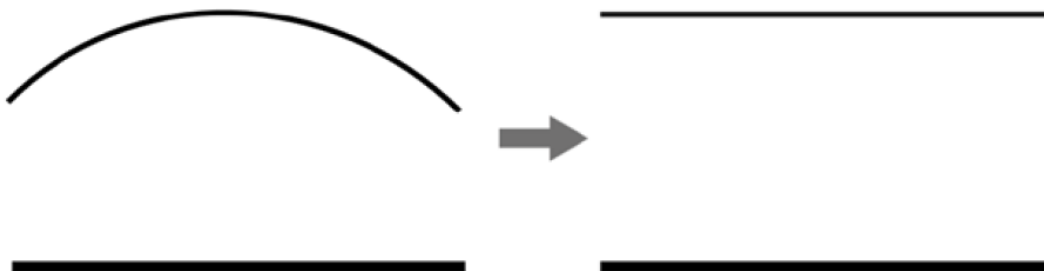

### ■ ColorShading (Color models only)

R-channel and B-channel properties are adjusted to using the G-channel shading properties as a reference.

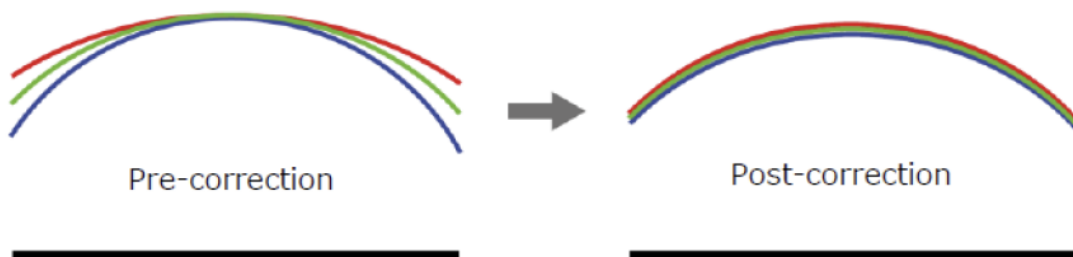



**Cautions:**

- For FlatShading and ColorShading, the maximum amount of correction gain for all pixels is limited to 8 times the amount of gain before correction. (The amount of gain cannot be increased to more than 8 times the amount of gain from before correction.)
- If the area in the screen with the highest brightness level is 1000 LSB or higher (during 10-bit video output), or if the lowest brightness level is less than 45 LSB (during 10-bit video output), proper correction is not possible.

**To Use the Shading Correction Function**

Configure the settings as follows.

Item	Setting Value	Description
ShadingCorrectionMode	FlatShading, ColorShading	Select the shading correction mode.
ShadingMode	User1, User2, User3, Off	Select the user area to which to save the shading correction value.

Display a white chart under a uniform light, and execute **PerformShadingCalibration**.

**Notes:**

- After shading correction is executed, the shading correction value is automatically saved to the user area selected in ShadingMode.
- The PerformShadingCalibration command cannot be executed under the following conditions. (An error also occurs when ShadingMode is set to Off).
  - When outputting no image.
  - When outputting TestPattern.
  - Width and/or Height are less than 512 ([ROI Function \(Single ROI\)](#))
  - In FD2x2Binning mode ([Binning Function](#))
  - In ImageScaling mode ([Image Scaling Mode \(Xscale\)](#))
  - In Decimation mode ([Decimation Mode](#))
  - In Sequencer mode ([Sequencer Function](#))
  - In MultiRoi mode ([ROI Function \(Multi ROI\)](#))
  - In Reverse mode ([Image Flip Function](#))
  - In GradationCompression mode ([Gradation Compression Mode](#))
  - In ALC mode ([ALC \(Automatic Level Control\) Function](#))
  - AcquisitionMode is set to other than Continuous ([AcquisitionControl](#))

# Binning Function

**Related Setting Items:** [ImageFormatControl](#)

The Binning function allows you to combine the signal values of clusters of adjacent pixels to create improved virtual pixels. Using the function results in images with a lower pixel resolution and higher sensitivity in summing mode or reduced noise in averaging mode.

This camera model supports the following binning modes:

- FD2x2BinningMode** (Floating diffusion binning)  
 Performs Horizontal x2 and Vertical x2 analog binning (Sum) on the sensor. This option increases the frame rate compared to the BinningHorizontal/BinningVertical options.
- BinningHorizontal, BinningVertical**  
 Performs Horizontal x2 and/or Vertical x2 digital binning (Sum or Average) on the FPGA.



**Notes:**

- Monochrome models only.
- Refer to [Functions That Cannot Be Used Together](#) for usage restrictions.

## How to Configure

When configuring **FD2x2BinningMode**, set the setting to **On**. When configuring **BinningHorizontal/BinningVertical**, set the setting to **2**.

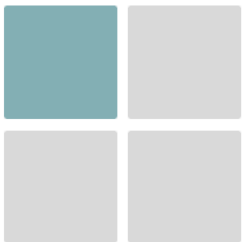
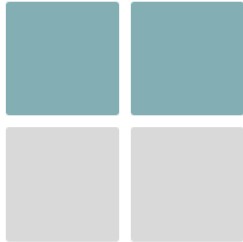
**Note:** **FD2x2BinningMode** and **BinningHorizontal/ BinningVertical** cannot be used together.

	Binning off	2 x 1	1 x 2	2 x 2
				
<b>FD2x2BinningMode</b>	OFF	N/A	N/A	ON
<b>BinningHorizontal</b>	1	2	1	2
<b>Binning Vertical</b>	1	1	2	2

## Image Scaling Mode (Xscale)

**Related Setting Items:** [ImageFormatControl](#)

JAI's Xscale algorithm digitally reduces the sensor's pixel resolution by specifying the vertical and horizontal scaling ratio. This function can also be used for color models and allows finer adjustment of resolution than the conventional [Binning Function](#).

The output image types are Average or Sum.

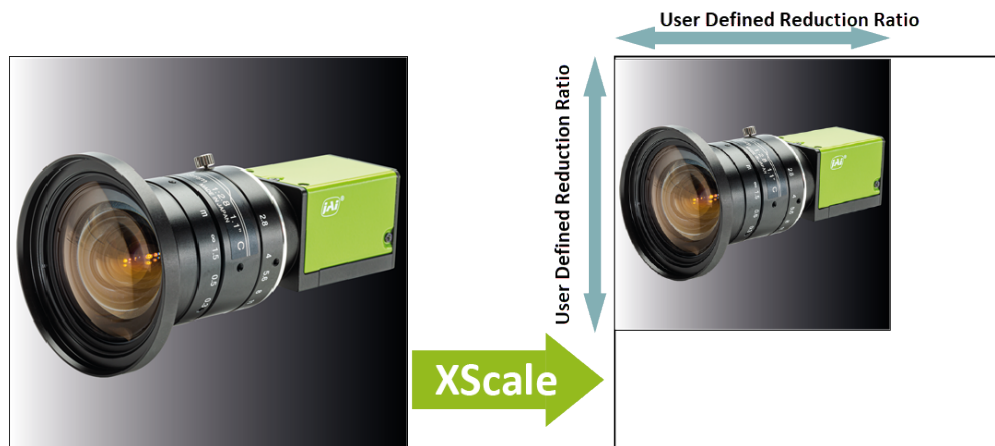

### Notes:

- When using this function with the [ROI Function \(Single ROI\)](#), first, set the Width, Height, OffsetX, and OffsetY settings, and then configure the Image Scaling Mode settings.
- Refer to [Functions That Cannot Be Used Together](#) for usage restrictions.

### How To Configure

1. If necessary, configure the [ROI Function \(Single ROI\)](#) settings.
2. Set ImageScalingMode (ImageFormatControl) to **On**.
3. Use **ImageScalingSumMode** to specify the output image mode. The options are "**Average** (Off)" or "**Sum** (On)." Depending on the mode, the output image's brightness will be different.

**Average Mode:** The average brightness of the sensor image is equal to the average brightness of the reduced output image.

**Sum Mode:** The sum of the brightness of all pixels in the sensor image and the sum of the brightness of all pixels in the reduced output image is equal, thus increasing the brightness of the output image.

4. Use **ImageScalingHorizontal** and **ImageScalingVertical** to specify the horizontal and vertical scaling ratio. For more information on how to specify the scaling ratio, see [Specifying the Scaling Ratio](#).

## Specifying the Scaling Ratio

Specify the scaling ratio in decimal point (maximum six decimal places) for **ImageScalingHorizontal** and **ImageScalingVertical**. The setting range is 0.0625 to 1. If "1" is specified, the image will not be scaled.

### Cautions:

- Xscale automatically rounds down the width to the nearest value that is a multiple of 4 and rounds down the height to the nearest value that is a multiple of 2.

Before rounding down, width and height calculations are first rounded (up or down) to seven significant digits. If the subsequent rounding down to the nearest multiple of 4 (or 2) results in a value that is beyond Xscale's maximum 16X scaling limit, the value is rounded up to the nearest multiple of 4 (or 2) and the corresponding **ImageScalingHorizontal/Vertical** value is adjusted accordingly.

- eBUS Player may automatically round the value and display a different value.

**Note:** When using Xscale, the horizontal and vertical scaling factors determine the size of the virtual pixels in the scaled image. This information, plus any ROI that has been preset by the user, determines the maximum number of whole virtual pixels possible in the output image.

### Example 1

If you want to output an image with 50% scaling both horizontally and vertically, set **ImageScalingHorizontal** and **ImageScalingVertical** to "0.5". (This is equivalent to the traditional 2 x 2 binning.)



## Example 2

When you are replacing your camera with a new one but the new camera has a different pixel size and resolution, you can reproduce the current camera's pixel size and output image size on the replacement camera, using the [ROI Function \(Single ROI\)](#) and `ImageScalingMode` functions.

This example shows how to configure the ROI and `ImageScalingMode` settings when replacing the GOX-2402C camera with the GOX-5105C camera.

	Pixel Size	Full Resolution (Width x Height)
Current Camera: GOX-2402C	3.45 $\mu\text{m}$ x 3.45 $\mu\text{m}$	1920 x 1200
New Camera: GOX-5105C	2.74 $\mu\text{m}$ x 2.74 $\mu\text{m}$	2472 x 2064

1. First, find the scaling ratio for the ROI. To make the virtual pixel size of the new camera (GOX-5105C) the same size as the current camera (GOX-2402C), the scaling ratio is "0.79" ( $2.74 \div 3.45 = 0.79$ ).
2. Next, configure the ROI settings for the new camera (GOX-5105C). Set the new camera's **Width** and **Height** (`ImageFormatControl`) as follows:
  - a. Width:  $1920 \div 0.79 = 2430$ . However, since the ROI Width Step is 4, set Width to "2432".
  - b. Height:  $1200 \div 0.79 = 1519$ . However, since the ROI Height Step is 2, set Height to "1520".

**Note:** If the specified ROI is larger than the supported resolution of the replacement camera, you will need to switch to a replacement camera with a higher resolution.

3. Turn the new camera's **ImageScalingMode On**.
4. Set **ImageScalingHorizontal** and **ImageScalingVertical** to "0.789474" ( $1920 \div 2432 = 0.789474$  and  $1200 \div 1520 = 0.789474$ ).

**Note:** `ImageScalingHorizontal` and `ImageScalingVertical` can be set up to 6 decimal places, but eBUS Player may automatically round the value and display a different value.

5. Now the new camera's virtual pixel size is 3.45  $\mu\text{m}$  x 3.45  $\mu\text{m}$ , and the output image size is 1920 x 1200.

### Example 3

If you are using a GOX-20405 camera with SensorWidth/SensorHeight of 4512, and you want to scale the output image to 3000 x 3000, set ImageScalingHorizontal and ImageScalingVertical to "0.6649" ( $3000 \div 4512 = 0.6649$ ).

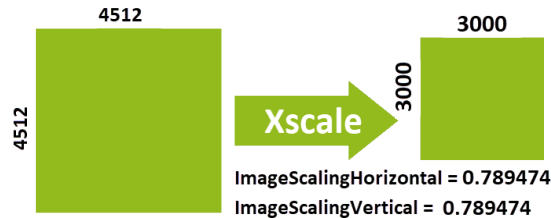

## Decimation Mode

**Related Setting Items:** [ImageFormatControl](#)

Decimation mode performs 2X downsampling of the image in both the horizontal and vertical direction. This reduces the file size for processing or storage while maintaining the full field of view of the image. Please set DecimationHorizontal, DecimationVertical in [ImageFormatControl](#).

### Notes:

- Refer to [Functions That Cannot Be Used Together](#) for usage restrictions.
- DecimationHorizontal and DecimationVertical cannot be set separately. For example, changing DecimationHorizontal to 2 will automatically change DecimationVertical to 2.
- When using Decimation Mode, the [ROI Function \(Single ROI\)](#) function can be configurable but may not operate as expected.

## Gradation Compression Mode

**Related Setting Items:** [ImageFormatControl](#)

This function compresses the bit depth of captured images to enable images containing a wide range of pixel values to be output as a narrower set of intensity gradations.

### Notes:

- This function cannot be used when [SensorDigitizationBits](#) is set to 8Bits.
- When GradationCompressionMode is turned On, the [Pixel Format](#) is forced to be controlled as follows:
  - Mono models: Mono8
  - Bayer format (color models): BayerRG8 (When ReverseX/Y is On, the flipped Bayer format is used).
  - RGB format (color models): RGB8

In Gradation Compression Mode, the sensor first converts the analog signal into 10bits or 12bits digital signal (= A/D conversion), and then the A/D-converted signal exceeding the compression knee point (s) is compressed and the entire image is output as 8bits data. (Whether A/D conversion is performed at 10 or 12 bits is based on the [SensorDigitizationBits](#) setting.)

The apparent sensitivity of the uncompressed area below the knee point is x4 at 10bits and x16 at 12bits.

The maximum value of each dynamic range is 400% at 10bits and 1600% at 12bits, comparing to the 8bits output.

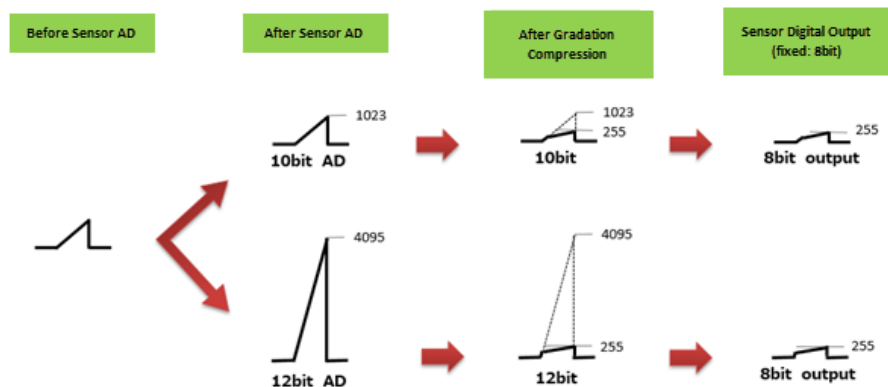

## How to Configure

1. Set **GradationCompressionMode** to **On** to enable the function.
2. Select a value for **GradationCompression1stKneePoint** to indicate where to start applying compression on the intensity values coming from the sensor. The knee point is specified as a percentage of the maximum digital value of the 8-bit compressed output (255).
3. Select a value for **GradationCompression1stGain** in order to set the slope angle at the first knee point. Available values range from 0 dB (no compression) to -66 dB.
4. Use **GradationCompression2ndKneePoint** and **GradationCompression2ndGain** to define an additional compression segment.

**Note:** 2ndKneePoint must be specified with a value greater than 1stKneePoint. The maximum value is 200% when SensorDigitizationBits is set to 10Bits, and 800% when SensorDigitizationBits is set to 12Bits.

## Examples

The following examples show how Gradation Compression knee points and gain can be calculated and applied.

### SensorDigitizationBits = 10Bits

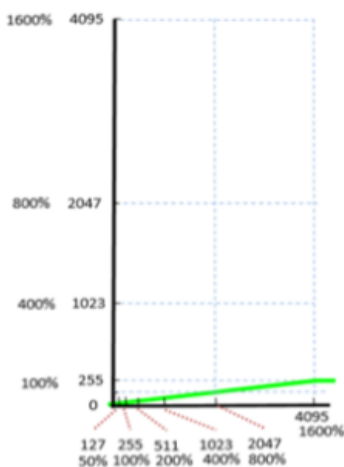

GradationCompressionMode = Off

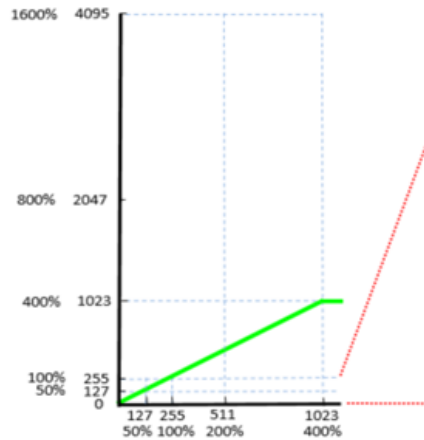

GradationCompressionMode = On  
GradationCompression1stGain = 0dB  
GradationCompression2ndGain = 0dB

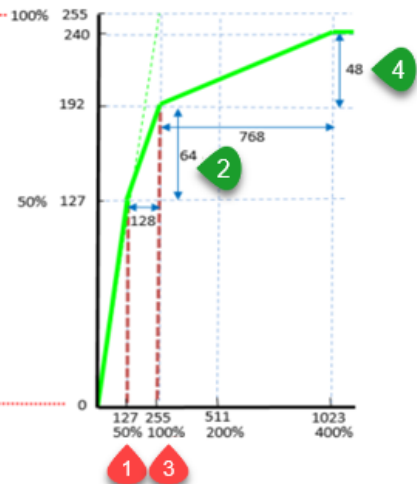

GradationCompressionMode = On  
 1 GradationCompression1stKneePoint = 50%  
 2 GradationCompression1stGain = - 6dB  
 ( $64/128 = 1/2 = -6dB$ )  
 3 GradationCompression2ndKneePoint = 100%  
 4 GradationCompression2ndGain = - 24dB  
 ( $48/768 = 1/16 = -24dB$ )



**SensorDigitizationBits = 12Bits**

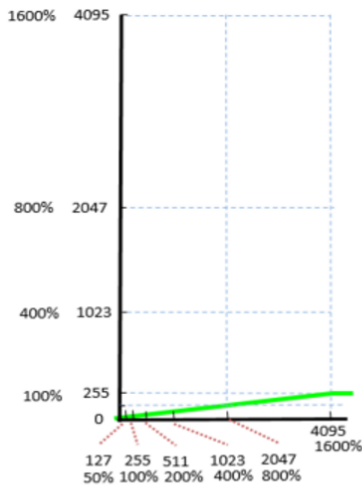

GradationCompressionMode = On

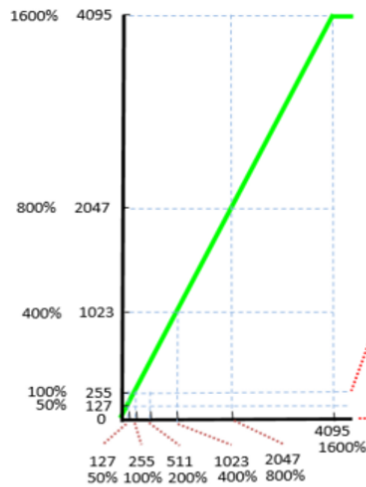

GradationCompressionMode = On  
 GradationCompression1stGain = 0dB  
 GradationCompression2ndGain = 0dB

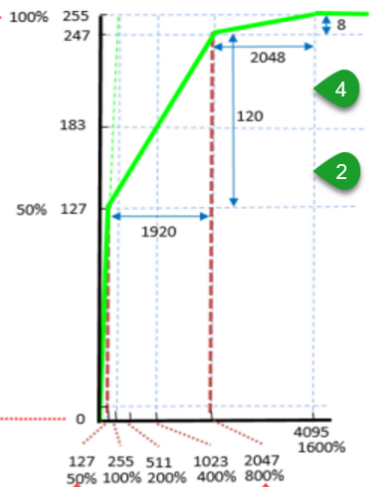

GradationCompressionMode = On  
 1 GradationCompression1stKneePoint = 50%  
 2 GradationCompression1stGain = - 24dB  
 (120/190 = 1/16 = -24dB)  
 3 GradationCompression2ndKneePoint = 800%  
 4 GradationCompression2ndGain = - 48dB  
 (8/2048 = 1/256 = -48dB)

**Cautions:**

- When VideoProcessBypassMode is set to **Off**, JAI cannot guarantee the configured knee point value because the GradationCompression1st(2nd)KneePoint value will not match the output signal's knee point level due to the effect of the digital gain value, which is performed during post-processing. In order to avoid this, set VideoProcessBypassMode = **On**.
- When VideoProcessBypassMode is set to **Off**, JAI cannot guarantee the white balance function's performance because the white balance function uses the digital gain during post-processing, and the output signal's knee point level between the RGB channels will not match. In order to avoid this, set VideoProcessBypassMode = **On**, and control the white balance on the Host side.

## Overlay Mode

Related Setting Items: [ImageFormatControl](#)

### Notes:

- This function cannot be used with the [Sequencer Function](#).
- This function is always Off when the camera is powered up.
- This function is always Off when AcquisitionStop is executed.

### OverlayMode = MultiRoiAreaMode

In this mode, you can check the readout area when using the [ROI Function \(Multi ROI\)](#). The area that is not readout is displayed with the brightness reduced to half. This makes it possible to set and adjust the readout area while checking the target area on the screen.

### Notes:

- To set Overlay Mode to **MultiRoiAreaMode**, MultiRoiMode ([MultiROIControl](#)) must be set to **Off** in advance.
- In the following scenario, OverlayMode = MultiRoiMode will be disabled (you can still set to **ALCAreaMode** or **AWBAreaMode**): DecimationVertical/DecimationHorizontal = 2, ImageScalingMode = On, BinningHorizontal = 2, BinningVertical = 2, FD2x2BinningMode = On

### OverlayMode = AWBAreaMode or ALCAreaMode

When Overlay Mode is set to **AWBAreaMode** or **ALCAreaMode**, you can check the photometry areas of WhiteBalance and ALC. In the non-target area as shown below, the brightness is reduced to half.

**MultiRoiAreaMode**



**AWBAreaMode or ALCAreaMode**

HighLeft	HighMidLeft	HighMidRight	HighRight
MidHighLeft	MidHighMidLeft	MidHighMidRight	MidHighRight
MidLowLeft	MidLowMidLeft	MidLowMidRight	MidLowRight
LowLeft	LowMidLeft	LowMidRight	LowRight

## ROI Function (Single ROI)

**Related Setting Items:** [ImageFormatControl](#)

The ROI (region of interest) function allows you to output images by specifying the areas to scan. Specify the area to scan by specifying width, height, and horizontal/vertical offset values under ImageFormatControl.

You can increase the frame rate by specifying a lower height, as the number of lines scanned decreases. The setting ranges for the ROI function's readable area based on the Binning setting (BinningHorizontal, BinningVertical, FD2x2BinningMode) are as follows.

### Notes:

- The [Binning Function](#) (Horizontal/Vertical Binning and FD2x2BinningMode) can only be used for monochrome camera models.
- When using this function with [Image Scaling Mode \(Xscale\)](#), first, set the Width, Height, OffsetX, and OffsetY settings, and then configure the Image Scaling Mode settings.
- When using Decimation Mode, the [ROI Function \(Single ROI\)](#) function can be configurable but may not operate as expected.
- Refer to [Functions That Cannot Be Used Together](#) for usage restrictions.

### Width/OffsetX (Pixels)

Width OffsetX	Binning Mode	Binning OFF	Binning ON (Mono models only)	*A,B = WidthMax		
					A	B
Width (pixels)	Horizontal Binning	96 to [( *A ) - OffsetX], step 8	48 to [( *B ) - OffsetX], step 4	GOX-5105MC-5GE	2472	1236
	FD2x2BinningMode			GOX-8105MC-5GE	2856	1428
Offset X (pixels)	Horizontal Binning	0 to [( *A ) - Width], step 8	0 to [( *B ) - Width], step 4	GOX-12405MC-5GE	4128	2064
				GOX-16205MC-5GE	5328	2664
	FD2x2BinningMode			GOX-20405MC-5GE	4512	2256
				GOX-24505MC-5GE	5328	2664

### Height/OffsetY (Lines)

Height OffsetY	Binning Mode	Binning OFF	Binning ON (Mono models only)	*C, D = HeightMax		
					C	D
Height (lines)	Vertical Binning	8 to [( *C ) - OffsetY], step 2	4 to [ ( *D ) - OffsetY], step 1	GOX-5105MC-5GE	2064	1032
	FD2x2BinningMode			GOX-8105MC-5GE	2848	1424
OffsetY (lines)	Vertical Binning	0 to [( *C ) - Height], step 2	0 to [ ( *D ) - Height], step 1	GOX-12405MC-5GE	3008	1504
	FD2x2BinningMode			GOX-16205MC-5GE	3040	1520
				GOX-20405MC-5GE	4512	2256
				GOX-24505MC-5GE	4608	2304

### Single ROI - Example

#### Binning Off

[BinningHorizontal]: 1, [BinningVertical]: 1

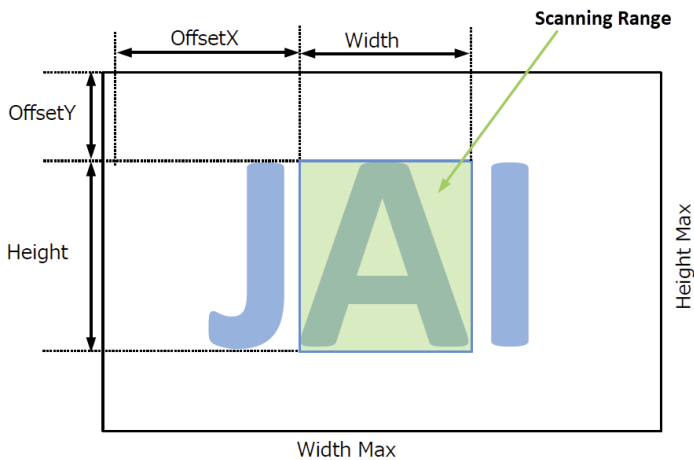

#### Binning On

[BinningHorizontal]: 2, [BinningVertical]: 2

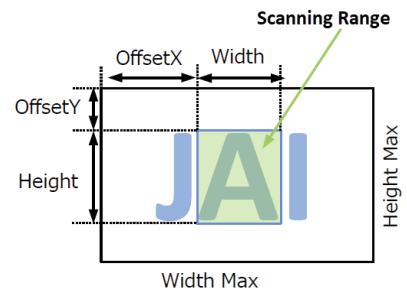

## ROI Centered

Related Setting Items: [ImageFormatControl](#)

When **ROI Centered** is set to **ON** while using the [ROI Function \(Single ROI\)](#), OffsetX is disabled and the image output position in the X direction is always forced to be centered.

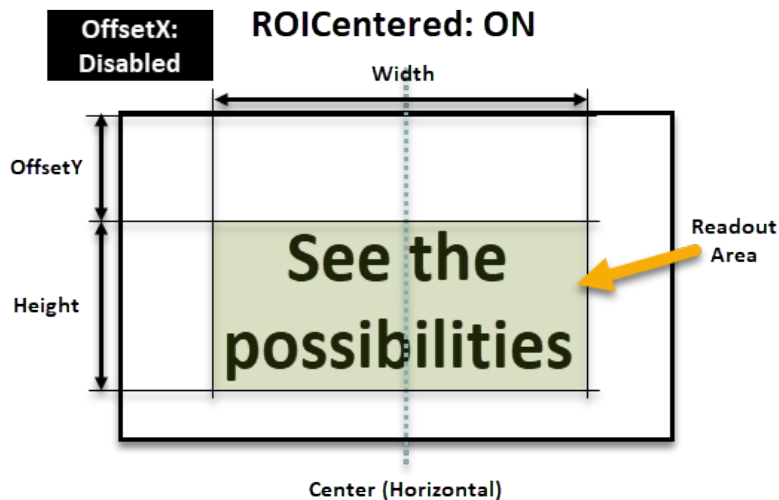

### Notes:

- Refer to [Functions That Cannot Be Used Together](#) for usage restrictions.
- When switching this function back to **Off**, the OffsetX value will be 0.

# ROI Function (Multi ROI)

Related Setting Items: [MultiROIControl](#)

**Notes:**

- Refer to [Functions That Cannot Be Used Together](#) for usage restrictions.
- If this function is turned on while [Shading Correction](#) is set to On, Shading Correction will be forced to Off.

In Multi ROI mode, you can specify up to 64 scanning areas for a single-frame image. By skipping areas that are not specified as regions of interest when scanning a frame, the ROI function outputs the specified regions in a combined state. You can increase the frame rate due to the reduced scanning time for the combined areas. However, you cannot increase the frame rate by compressing in the horizontal direction.

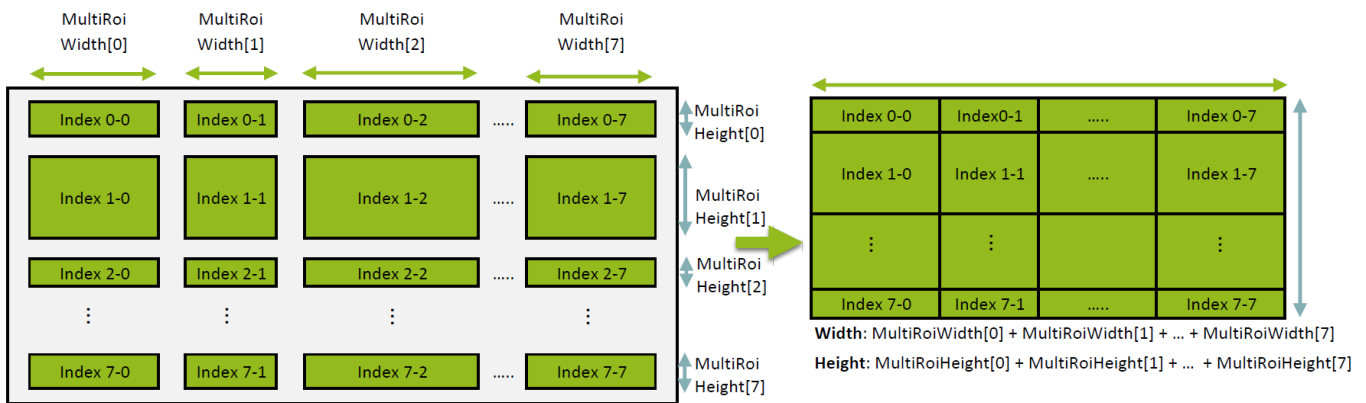

## How to Configure

1. Set **MultiRoiMode (MultiROIControl)** to **On**.
2. Select from the eight indexes in **MultiRoiIndex** then set **MultiRoiWidth**, **MultiRoiHeight**, **MultiRoiOffsetX**, and **MultiRoiOffsetY**.
3. Set the maximum index number to be enabled to **MultiRoiVerticalEnableNumber** and **MultiRoiHorizontalEnableNumber**.

**Caution:** The specified areas cannot overlap. If the areas overlap, all indexes after the overlapping areas become unconfigurable.

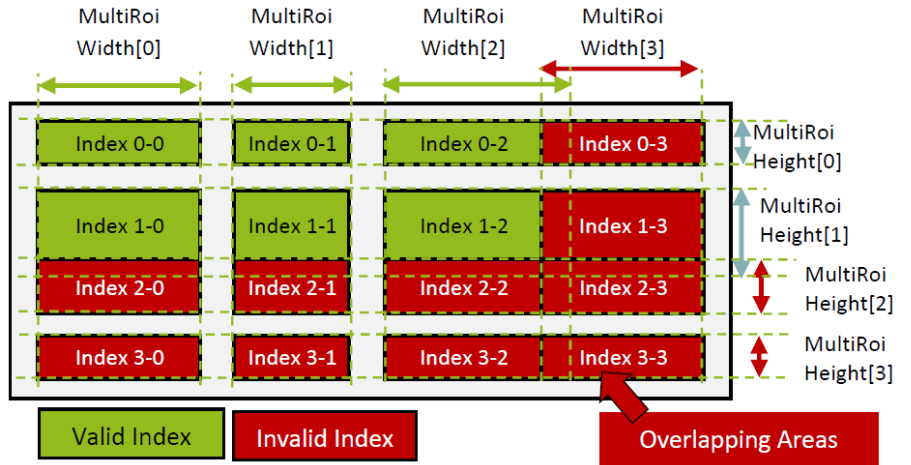

**Notes:**

- The frame rate can be increased in relation to the size of the area specified in the vertical direction, but not in relation to the horizontal direction.

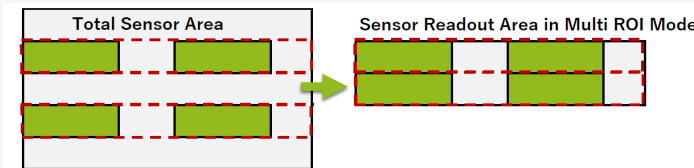

- In the horizontal direction, the configuration for the second and subsequent rows will be identical. In the vertical direction, the configuration for the second and subsequent columns will be identical.

## Configuration Example

To use four areas as shown below, refer to the following.

1. Set MultiROIControl->**MultiRoiMode On**.
2. Select "0" in MultiRoiIndex. Set MultiRoiWidth, MultiRoiHeight, MultiRoiOffsetX and MultiRoiOffsetY.
3. Select "1" in MultiRoiIndex. Set MultiRoiWidth, MultiRoiHeight, MultiRoiOffsetX and MultiRoiOffsetY.
4. Set 2 to MultiRoiVerticalEnableNumber.
5. Set 2 to MultiRoiHorizontalEnableNumber.

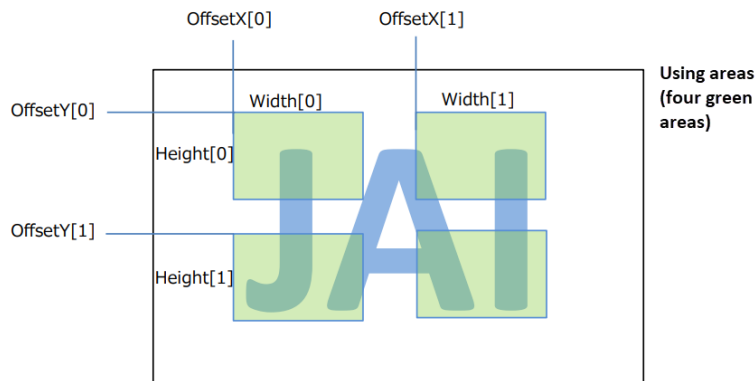

Output image

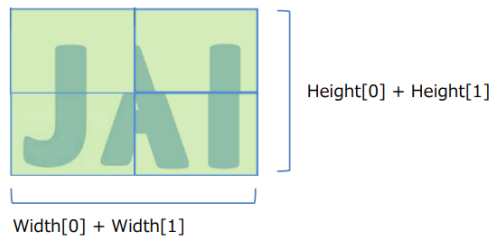



## Color Space Conversion (ColorTransformationControl)

Related Setting Items: [ColorTransformationControl](#)

**Note:** This function is available only when the [Pixel Format](#) is set to **RGB8**, **RGB10V1Packed**, or **RGB10p32**.

This camera allows you to convert the standard color space (RGB) that is used to produce colors into other color spaces, including XYZ. Four color spaces are available: RGB(sRGB), RGB(AdobeRGB), RGB(UserCustom), XYZ. Specify the desired color space by configuring ColorTransformationMode and ColorTransformationRGBMode as follows.

ColorTransformation	ColorTransformationMode	ColorTransformationRGBMode
RGB (sRGB)	RGB	sRGB
RGB (AdobeRGB)	RGB	AdobeRGB
RGB (UserCustom)	RGB	UserCustom
XYZ	XYZ	Off
Default	RGB	Off

### Note on RGB (UserCustom)

This allows you to use user-configured 3x3 conversion tables to perform color space conversion.

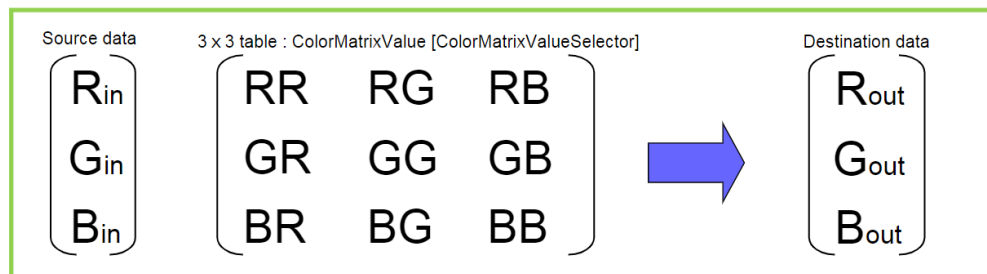

**Caution:** If you set the color space to XYZ, Control Tool will not display the images captured by the camera properly. To display them properly, XYZ-compatible image processing must be performed on the computer side.

### Configuration 3x3 table

1. Select the item you want to configure in ColorMatrixValueSelector.
2. Configure the value in ColorMatrixValue.

3. ColorMatrixValue can be set to a value from -2 to +2.

See [ColorTransformationControl](#) for detailed information on the setting items.

## Edge Enhancer, Color Enhancer

**Related Setting Items:** [ImagingControl](#)

This camera is equipped with an Edge Enhancer function for enhancing the contrast of lines or edges within images and a Color Enhancer function for enhancing specified colors.

### Edge Enhancer Function

**Note:** On this camera, the Edge Enhancer function is only available for monochrome models.

The Edge Enhancer function is enabled when EdgeEnhancerEnable is set to On. Four enhancement levels are available: Low, Middle, High, and Strong.

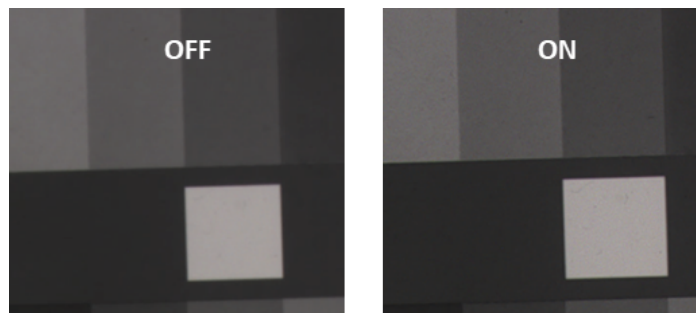

### Color Enhancer Function

**Note:** This function is available only when the [Pixel Format](#) is set to **RGB8**, **RGB10V1Packed**, or **RGB10p32**.

The Color Enhancer function is enabled when ColorEnhancerEnable is set to On. Set a value from 0 to 1.0 (0.1 steps) for ColorEnhancerValue to configure the enhancement level: 0 = no enhancement, 1.0 = approx. x2 the color level of the original data.

Six colors can be specified in ColorEnhancerSelector: Red, Cyan, Green, Magenta, Blue, and Yellow.

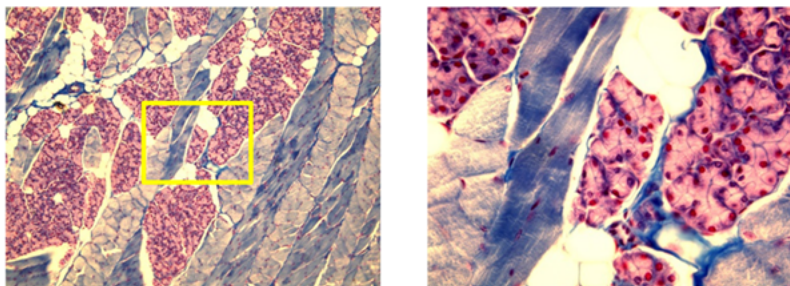

## Sequencer Function

---

**Related Setting Items:** [SequencerControl](#)

The Sequencer function lets you define up to 32 index combinations of exposure time, gain, ROI, and other settings which can be stepped through each time a trigger is received. This is particularly useful for quickly capturing multiple exposures of objects under inspection to adjust for areas or components with significantly different levels of reflectance. You can specify the next index in the stepping sequence and the order in which indexes are executed. Multiple indexes can also be executed repeatedly.

Two operation modes (TriggerSequencer mode and CommandSequencer mode) are available for the Sequencer function.

### Notes:

- Refer to [Functions That Cannot Be Used Together](#) for usage restrictions.
- Up to 32 indexes can be configured. For details on the items that can be set for each index, see [SequencerControl](#).

### Cautions:

- If the values of [ImageFormatControl](#)'s Width and Height are smaller than SequencerControl's SequencerWidth and SequencerHeight, the image may not be output correctly.
- When using SequencerWidth / SequencerHeight, set the Width and Height to the default values in advance.

## TriggerSequencer Mode

With this mode, the Sequencer Trigger “pattern” is predetermined by the user. The user defines up to 32 different “indexes.” Different camera settings can be configured for each index. The operation of this mode is controlled using the following five commands.

**Caution:** In TriggerSequencer mode, the TriggerOverlap function of the FrameStart trigger is disabled and the operation is always Off.

- **SequencerSetActive:** This allows you to confirm the index number displayed on the next trigger reception.
- **SequencerSetStart:** This configures the index number to execute at the start of TriggerSequencer mode.

- **SequencerFrameCount:** This configures the number of frame acquisitions for the selected SequencerIndex.
- **SequencerReset:** During TriggerSequencer mode operation, this switches the index number to be executed to that specified in SequencerSetStart.
- **SequencerRepetition:** This parameter applies to TriggerSequencer patterns which include an index whose SequencerROINextIndex is set to 0 (OFF).

When the index whose SequencerROINextIndex is set to 0 (OFF) is finished executing, the value of Sequencer Repetition (range = 1 ~ 255) is decremented internally. If the result of the decrement is not zero, the TriggerSequencer pattern starts over from the index specified in SequencerSetStart. If the result of the decrement is zero, the status changes to Acquisition Stop and external triggers are not accepted.

## Sample TriggerSequencer Mode Operation

User-Defined Indexes (Up to 32)

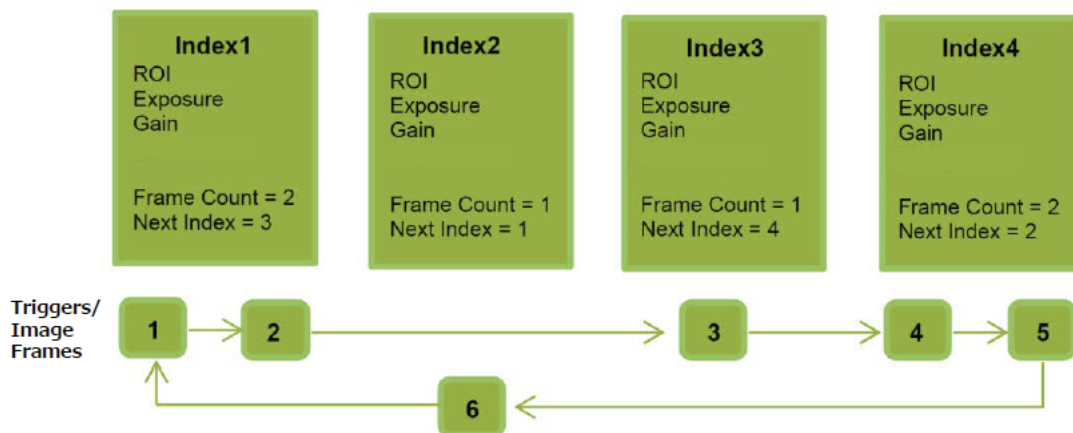

1. Specify "1" in SequencerSetStart and start TriggerSequencer mode with index 1.
2. Based on the SequencerFrameCount setting (= 2), capture a 2-frame image with the first and second triggers.
3. For the next index, configure index 3 specified in SequencerSetNext, and capture an image with the number of frames (the number of triggers) specified in SequencerFrameCount (=1).
4. Proceed to sequence from index 4 to index 2 to index 1.

**Note:** In addition to repeating multiple conditions as in the above example, you can specify "0" (which indicates the end of TriggerSequencer mode) in SequencerSetNext of index 2 and specify the number of repetitions in SequencerRepetition.

## CommandSequencer Mode

As with TriggerSequencer mode, you can define up to 32 indexes beforehand in this mode. Set SequencerCommandIndex to point to one of your preconfigured indexes. This index will be executed on each trigger, until it is changed to point to a different index, typically by your vision application.

In this way, Command Sequencer mode allows you to programmatically adjust your sequence in response to image analysis or input from other sensors.

### Notes:

- The same index table will be executed for subsequent triggers unless the CommandSequencerIndex value is changed.
- SequencerFrameCount, SequencerSetNext and SequencerRepetition cannot be used in CommandSequencer mode.

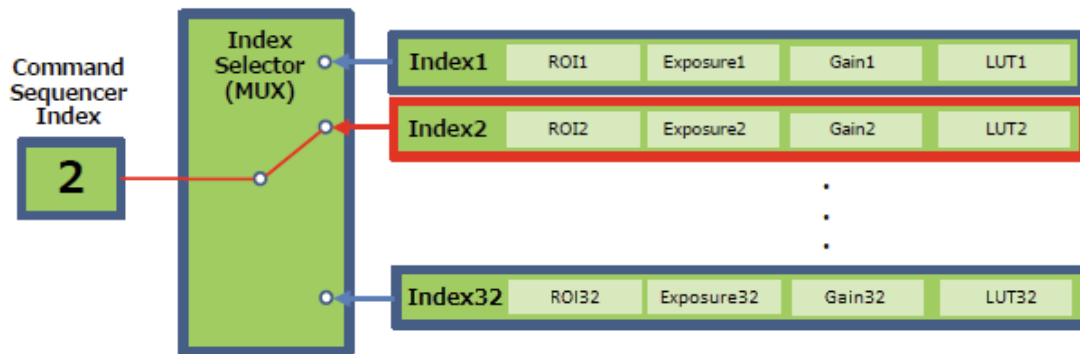

# Pulse Generator

Related Setting Items: [PulseGenerator](#)

## Technical Notes Tips for using the Pulse Generator

By using this function, any signal can be generated inside the camera.

The following is an example of signal generation.

### Settings

- PulseGeneratorStartPoint = 2
- PulseGeneratorEndPoint = 6
- PulseGeneratorLength = 10
- PulseGeneratorPulseWidth = 4
- PulseGeneratorClearSyncMode = AsyncMode

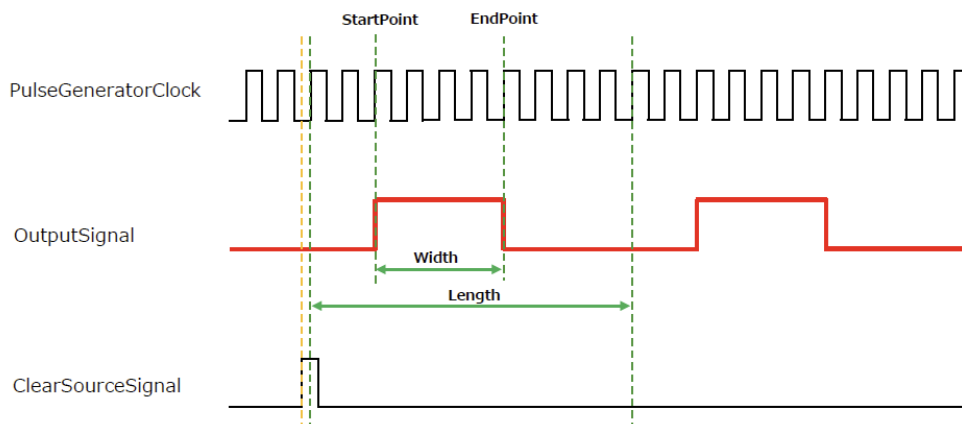

The table below shows the PulseGeneratorClearSource signals that can be set.

	Off	AcquisitionActive	FrameActive	ExposureActive	FVAL	PulseGenerator0	PulseGenerator1	PulseGenerator2	PulseGenerator3	UserOutput0	UserOutput1	UserOutput2	UserOutput3	Line5 Opt In1	NAND0 Out	NAND1 Out	Low	High	AcquisitionTriggerWait	FrameTriggerWait	
PulseGenerator0		✓	✓	✓	✓		✓	✓	✓	✓	✓	✓	✓	✓	✓	✓	✓	✓	✓	✓	✓
PulseGenerator1		✓	✓	✓	✓	✓		✓	✓	✓	✓	✓	✓	✓	✓	✓	✓	✓	✓	✓	✓
PulseGenerator2		✓	✓	✓	✓	✓	✓		✓	✓	✓	✓	✓	✓	✓	✓	✓	✓	✓	✓	✓
PulseGenerator3		✓	✓	✓	✓	✓	✓	✓		✓	✓	✓	✓	✓	✓	✓	✓	✓	✓	✓	✓

## Counter and Timer Control Function

**Related Setting Items:** [CounterAndTimerControl](#)

**Note:** This camera supports only the counter function.

The counter function counts up change points in the camera’s internal signals using the camera’s internal counter and reads that information from the host side. This function is useful for verifying error conditions via the count value using internal camera operations.

Four counters are available on the camera; Counter0, Counter1, Counter2, and Counter3. The functions that can be counted are fixed for each counter.

- Counter0: Counts the number of FrameTrigger.
- Counter1: Counts the number of ExposureStart.
- Counter2: Counts the number of SensorReadOut.
- Counter3: Counts the number of FrameTransferEnd.

When a problem occurs in a system that includes this camera, comparing the values from multiple counters allows you to verify the extent of normal operability and can be useful when investigating the cause of the problem.

### Counter Occurrence Diagram

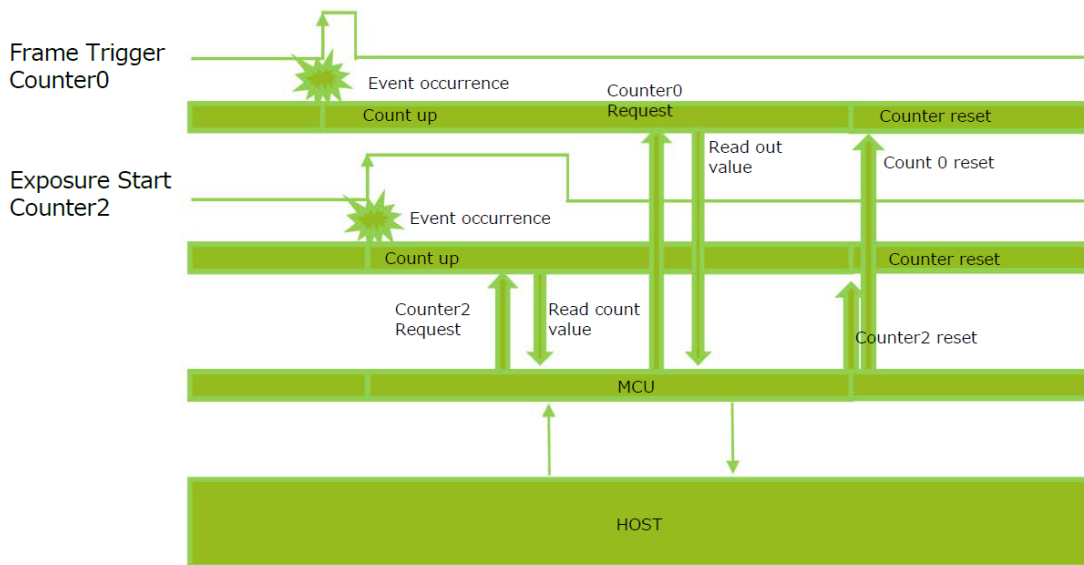

**Note:** You can reset a specific counter's count value by executing CounterReset[Counter0, Counter1, Counter2, Counter3].

## Internal Camera Blocks

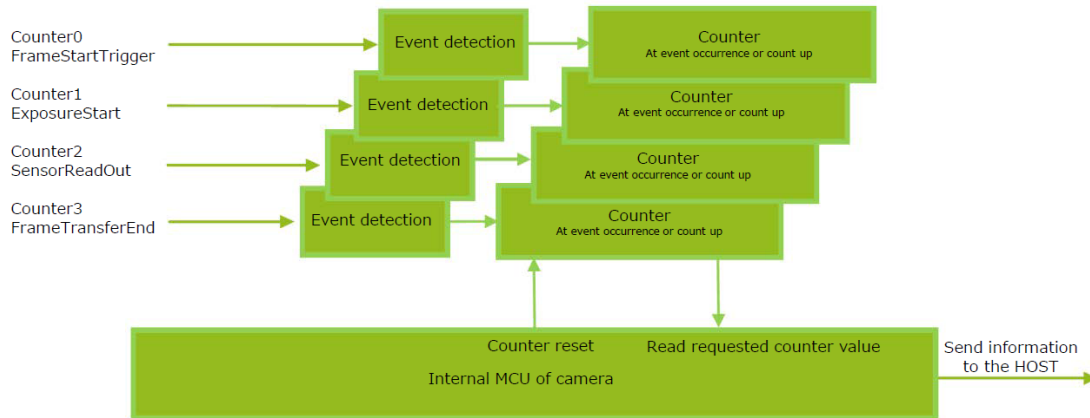

## To Use the Counter Function

Configure the settings as follows.

Four counters are available. Specify a counter (Counter0 to Counter3), and configure the settings.

Item	Setting Value Selectable Range	Description
Counter 0 ~ 3	Counter 0 ~ 3	Select the counter.
CounterEventSource	Counter0: Off, Frame Trigger Counter1: Off, ExposureStart Counter2: Off, SensorReadOut Counter3: Off, FrameTransferEnd	Select the Counter Event signal for which to read the count value.  When set to Off, the counter operation will stop (but will not be reset).
CounterEventActivation	When the Counter function is enabled: Counter0, Counter1, Counter2 = RisingEdge (Fixed) Counter3 = FallingEdge (Fixed)	Specify timing at which to count.



## Action Control Function

---

Related Setting Items: [ActionControl](#)



Technical Notes

How to use GigE Vision Action Commands

The Action Control Function is a function that executes the pre-configured action when the camera receives action commands. Action commands can send both unicast and broadcast messages and give instructions for actions to multiple cameras simultaneously by broadcasting them. A camera that has this function can even give instructions for actions to different types of multiple cameras. Although this function includes jitter and delays, it is useful for controlling multiple cameras simultaneously.

When the [PTP \(Precision Time Protocol\)](#) function is turned on, Scheduled Action Command (Action Control function) becomes available, which allows you to send Action Commands to multiple cameras synchronized with PTP at the same time.

Actions are performed when the following three conditions are met.

1. ActionDeviceKey set to the camera and ActionDeviceKey in the action command match.
2. ActionGroupKey set to the camera and ActionGroupKey in the action command match.
3. ActionGroupMask set to the camera and GroupMask in the action command perform AND operation, and the result is not 0.

### How to Configure

1. Specify ActionDeviceKey.
2. Then, specify two actions that can be configured on the camera.
  - a. Action1
    1. Select 1 in ActionSelector.
    2. Specify ActionGroupMask [ActionSelector].
    3. Specify ActionGroupKey [ActionSelector].
  - b. Action2
    1. Select 2 in ActionSelector.
    2. Specify ActionGroupMask [ActionSelector].
    3. Specify ActionGroupKey [ActionSelector].
3. Set triggers (AcquisitionStart, AcquisitionEnd, FrameStart, AcquisitionTransferStart) to Action1 and Action2.

## Action Control Example

Assume that the following settings have been pre-configured on the camera.

- ActionDeviceKey : 0x00001001
- ActionGroupMask[1] : 0x00000011
- ActionGroupKey[1] : 0x00000001
- ActionGroupMask[2] : 0x00000111
- ActionGroupKey[2] : 0x00000002

When the camera receives action commands (ActionDeviceKey:0x00001001, ActionGroupMask:0x00000011, ActionGroupKey: 0x00000002), Action2 is executed.

When the camera receives action commands (ActionDeviceKey:0x00001001, ActionGroupMask:0x00000011, ActionGroupKey: 0x00000001), ActionDevice and ActionGroupKey [1] match. However, the result of AND operation performed by ActionGroupMask is 0. Therefore, in this case, neither Action1 nor Action2 is executed.

## Chunk Data Function

---

**Related Setting Items:** [ChunkDataControl](#)

The Chunk Data function adds camera configuration information to the image data that is output from the camera. In addition, when images are shot with a single camera in sequence under multiple setting conditions, you can search for images by their setting conditions.

### ■ Configuring Chunk Data

1. Set **ChunkModeActive** to **True**.

**Caution:** The Chunk Data function settings cannot be changed during image output. To change the settings, stop Acquisition.

## Event Control Function

Related Setting Items: [EventControl](#)

The Event Control function is a function that outputs a signal change point inside the camera as information indicative of an event occurrence (event message).

### Flow from Detecting an Event to Sending an Event Message

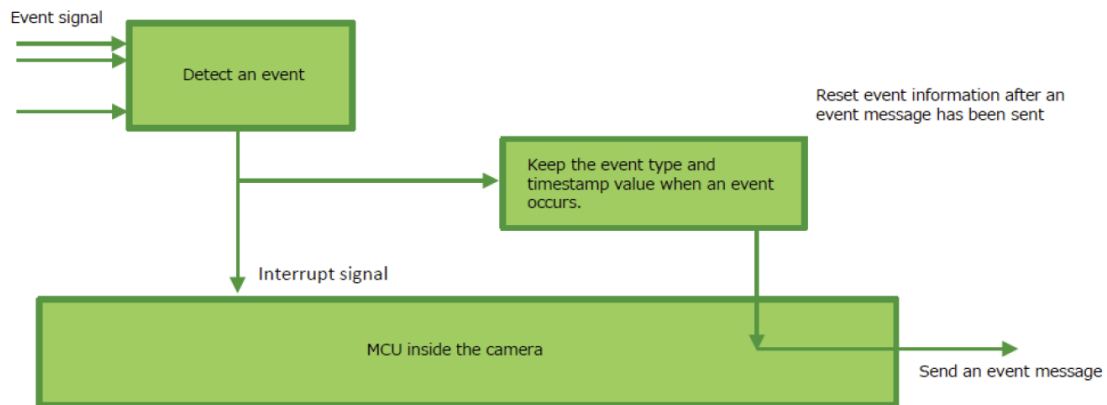

### Events That Can Use the Event Control Function

Events that can use the Event Control function are as follows. You can specify whether or not to send an event message when an event occurs at each event.

- AcquisitionTrigger
- FrameStart
- FrameEnd
- ExposureStart
- ExposureEnd

## PTP (Precision Time Protocol)

**Related Setting Items:** [TransportLayerControl](#)

The camera can work as the slave for Precision Time Protocol defined in IEEE 1588. When the IEEE 1588 master clock exists in the network where the camera is connected, this function synchronizes the camera to the time of the master clock.

- Transport to be used: Multicast UDP datagram (224.0.1.129); however, Delay Resp is a unicast UDP datagram.
- Destination port number:
  - 319: Sync, Delay Req, Pdelay Req, Pdelay Resp
  - 320: Announce, Follow Up, Delay Resp, Pdelay Resp, Management, Signaling
- Items for synchronization: Time synchronization is performed. Frequency tuning is not performed.
- PTP time data: 80 bit (elapsed time in 1 ns, with 00:00:00, January 1 1970 set as the origin)
- Timestamp (this camera): 64 bit\* (PTP synchronization: LSB64bit\* of PTP time data)
- Supported PTP messages: Announce message (receive only), Sync message (receive only), Follow Up message (receive only), Delay Req message (send only), Delay Resp message (receive only)

### Cautions:

- The Timestamp Tick Frequency register value is fixed at 1,000,000,000 (1 GHz).
- When PTP synchronization is being performed, the Timestamp Reset function is disabled.
- Because GenICam treats the timestamp (64 bit) as a 64 bit signed integer, 63 bit is actually timestamp data without the sign bit.

### How To Configure

1. Set **GevIEEE1588** ([TransportLayerControl](#)) to **True**.
2. After several statuses from Disable, when a Sync Message is received from the PTP server, **Slave** is Displayed in **GevIEEE1588 Status**.

**Note:** When the PTP function is **On**, you can use Scheduled Action Command ([ActionControl](#)), which allows you to send action commands to multiple cameras synchronized with PTP at the same time.

## Temperature Warning Mode

---

**Related Setting Items:** [DeviceControl](#)

Temperature Warning Mode allows you to automatically control the camera to prevent safety hazards or camera malfunctions due to heat generated by the camera. This mode, which is set to On by default, automatically lowers the frame rate to reduce the heat generation when the camera's internal temperature rises significantly. If the internal temperature continues to rise and reaches the [Maximum Allowable Temperature](#), the camera will become uncontrollable from the host side.

### Notes:

- Temperature Warning Mode operates regardless of the power source (PoE or 6-pin).
- Even if TemperatureWarningMode is set to Off, if the internal temperature continues to rise and reaches the maximum allowable temperature ("Disconnect" status of this mode), the camera will become uncontrollable from the host side.
- For permanent temperature countermeasures, see "[Notes on Supplying Power via PoE](#)".

### How to Configure

1. Set **TemperatureWarningMode** ([DeviceControl](#)) to **On** (Default = On).
2. The camera's temperature status can be checked using **TemperatureWarningStatus** (Normal, Warning, PowerSave, StopImage, or Disconnect).

### Camera Operation in Temperature Warning Mode

In Temperature Warning Mode, if the temperature of the FPGA, Sensor, or PHY is equal to or greater than the temperature specified in each status (see the table below), the displayed image changes and the camera operation is restricted. For example, if FPGA = 65°C, Sensor = 79°C, PHY = 80°C, the PHY temperature is considered to have reached the "Warning" status temperature, which forces the brightness of the outer frame of the image to be reduced to 50%.

### Notes:

- To return to the previous status, the temperature of the FPGA, Sensor, and PHY must all be 5°C below that status. For example, to return from Warning status to Normal status, the FPGA must be less than 65°C and the Sensor and PHY must be less than 75°C.
- You can monitor the camera's internal temperature using **DeviceTemperature**.

Image	Status, Temperature and Camera Operation											
	<table border="1" data-bbox="451 285 1528 390"> <thead> <tr> <th data-bbox="451 285 669 331">WarningStatus</th> <th data-bbox="669 285 954 331">FPGA</th> <th data-bbox="954 285 1247 331">Sensor</th> <th data-bbox="1247 285 1528 331">PHY</th> </tr> </thead> <tbody> <tr> <td data-bbox="451 331 669 390">Normal</td> <td data-bbox="669 331 954 390">Less than 70°C</td> <td data-bbox="954 331 1247 390">Less than 80°C</td> <td data-bbox="1247 331 1528 390">Less than 80°C</td> </tr> </tbody> </table> <ul data-bbox="500 422 870 453" style="list-style-type: none"> <li>No operational restrictions</li> </ul>				WarningStatus	FPGA	Sensor	PHY	Normal	Less than 70°C	Less than 80°C	Less than 80°C
WarningStatus	FPGA	Sensor	PHY									
Normal	Less than 70°C	Less than 80°C	Less than 80°C									
<p data-bbox="131 527 435 594">Reduce the outer frame brightness by 50%</p> 	<table border="1" data-bbox="451 527 1528 632"> <thead> <tr> <th data-bbox="451 527 669 573">WarningStatus</th> <th data-bbox="669 527 954 573">FPGA</th> <th data-bbox="954 527 1247 573">Sensor</th> <th data-bbox="1247 527 1528 573">PHY</th> </tr> </thead> <tbody> <tr> <td data-bbox="451 573 669 632">Warning</td> <td data-bbox="669 573 954 632">70°C</td> <td data-bbox="954 573 1247 632">80°C</td> <td data-bbox="1247 573 1528 632">80°C</td> </tr> </tbody> </table> <ul data-bbox="500 663 1515 884" style="list-style-type: none"> <li>The brightness of the outer frame of the image is reduced by 50% to indicate that the internal temperature has exceeded the specified value.</li> <li>Forcibly disable <u>Overlay Mode</u> if this function is set to anything other than Off.</li> <li>When the camera's internal temperature drops and automatically returns to the Normal status, Overlay Mode remains Off.</li> </ul>				WarningStatus	FPGA	Sensor	PHY	Warning	70°C	80°C	80°C
WarningStatus	FPGA	Sensor	PHY									
Warning	70°C	80°C	80°C									
<p data-bbox="131 957 435 1024">Flash the outer frame (2Hz cycle)</p> 	<table border="1" data-bbox="451 909 1528 1014"> <thead> <tr> <th data-bbox="451 909 669 955">WarningStatus</th> <th data-bbox="669 909 954 955">FPGA</th> <th data-bbox="954 909 1247 955">Sensor</th> <th data-bbox="1247 909 1528 955">PHY</th> </tr> </thead> <tbody> <tr> <td data-bbox="451 955 669 1014">PowerSave</td> <td data-bbox="669 955 954 1014">75°C</td> <td data-bbox="954 955 1247 1014">85°C</td> <td data-bbox="1247 955 1528 1014">85°C</td> </tr> </tbody> </table> <ul data-bbox="500 1045 1520 1423" style="list-style-type: none"> <li>The flashing outer frame of the image indicates a warning that the internal temperature has risen to a level that requires power saving.</li> <li>Reduces the frame rate to 50% of the maximum AcquisitionFrameRate value. However, when in Trigger Mode, or acquiring images at 50% or less of the maximum AcquisitionFrameRate value, the frame rate remains unchanged (only the outer frame of the image flashes).</li> <li>When the camera's internal temperature drops and automatically returns to the Warning status, the frame rate remains at 50% of the maximum AcquisitionFrameRate value.</li> </ul> <p data-bbox="483 1476 1450 1539"><b>Note:</b> If the frame rate is less than 2Hz, the outer frame of the image will not flash.</p>				WarningStatus	FPGA	Sensor	PHY	PowerSave	75°C	85°C	85°C
WarningStatus	FPGA	Sensor	PHY									
PowerSave	75°C	85°C	85°C									

Image	Status, Temperature and Camera Operation											
<p>Reduce overall image brightness by 50%</p> 	<table border="1"> <thead> <tr> <th data-bbox="440 222 669 277">WarningStatus</th> <th data-bbox="669 222 950 277">FPGA</th> <th data-bbox="950 222 1247 277">Sensor</th> <th data-bbox="1247 222 1533 277">PHY</th> </tr> </thead> <tbody> <tr> <td data-bbox="440 277 669 331">StopImage</td> <td data-bbox="669 277 950 331">90°C</td> <td data-bbox="950 277 1247 331">95°C</td> <td data-bbox="1247 277 1533 331">95°C</td> </tr> </tbody> </table>	WarningStatus	FPGA	Sensor	PHY	StopImage	90°C	95°C	95°C			
WarningStatus	FPGA	Sensor	PHY									
StopImage	90°C	95°C	95°C									
<p>No image</p> 	<table border="1"> <thead> <tr> <th data-bbox="440 669 669 724">WarningStatus</th> <th data-bbox="669 669 950 724">FPGA</th> <th data-bbox="950 669 1247 724">Sensor</th> <th data-bbox="1247 669 1533 724">PHY</th> </tr> </thead> <tbody> <tr> <td data-bbox="440 724 669 779">Disconnect</td> <td data-bbox="669 724 950 779">95°C</td> <td data-bbox="950 724 1247 779">100°C</td> <td data-bbox="1247 724 1533 779">100°C</td> </tr> </tbody> </table>	WarningStatus	FPGA	Sensor	PHY	Disconnect	95°C	100°C	100°C			
WarningStatus	FPGA	Sensor	PHY									
Disconnect	95°C	100°C	100°C									
<ul style="list-style-type: none"> <li>The brightness of the entire screen is reduced to 50% to alert the user that the internal temperature has risen to a level that requires further power saving.</li> <li>Stops image acquisition. Once stopped, you cannot resume image acquisition while in the StopImage status.</li> <li>When the camera's internal temperature drops and automatically returns to the PowerSave status, the image acquisition will not resume (you must manually start image acquisition).</li> </ul> <ul style="list-style-type: none"> <li>The camera's internal temperature has reached the maximum allowable temperature. The connection to the camera is disconnected, and the image is not displayed.</li> <li>The camera becomes uncontrollable from the host side. To regain control of the camera from the host side, you must turn off the power supply once.</li> <li>Even if the camera's internal temperature drops, the camera will not automatically return to the StopImage status.</li> </ul> <p><b>Caution:</b> To avoid the camera going into the Disconnect status again, cooling measures must be taken. For permanent temperature countermeasures, see "<a href="#">Notes on Supplying Power via PoE</a>".</p>												

## Functions That Cannot Be Used Together

The table below shows functions that cannot be used with [ImageFormatControl](#), [MultiROIControl](#) and [SequencerControl](#) setting items.

**Note:** For functions that are not in this table, refer to the relevant function topic or setting item topic.

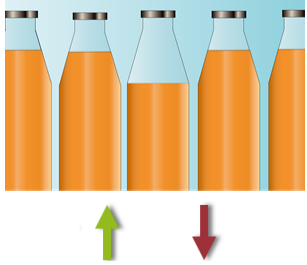
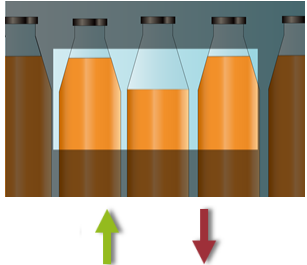
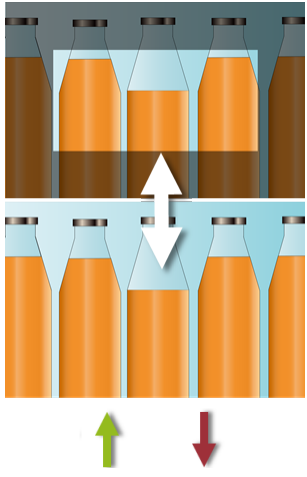
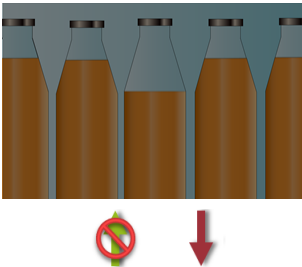
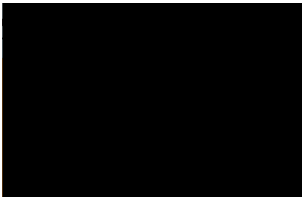
	Width, Height, OffsetX, OffsetY	ROICentered	FD2x2BinningMode	BinningHorizontal = 2	BinningVertical = 2	ImageScalingMode	DecimationHorizontal/Vertical	ReverseX/Y	GradationCompressionMode	ALCAreaMode/AWBAreaMode	OverlayMode = MultiROIAreaMode	MultiRoiMode	SequencerMode
Width, Height, OffsetX, OffsetY (SingleROI)		1				2	⚠						
ROICentered	1		⊘	⊘		⊘	⊘			⊘		⊘	⊘
FD2x2BinningMode		⊘		⊘		⊘	⊘				⊘	⊘	⊘
BinningHorizontal = 2		⊘	⊘			⊘	⊘				⊘	⊘	
BinningVertical = 2			⊘			⊘	⊘				⊘	⊘	
ImageScalingMode	2	⊘	⊘	⊘			⊘				⊘	⊘	⊘
DecimationHorizontal/Vertical = 2	⚠	⊘	⊘	⊘		⊘					⊘	⊘	⊘
ReverseX/Y													⊘
GradationCompressionMode													⊘
OverlayMode = ALCAreaMode/AWBAreaMode		⊘											⊘
OverlayMode = MultiRoiAreaMode			⊘	⊘	⊘	⊘	⊘					3	⊘
MultiRoiMode		⊘	⊘	⊘	⊘	⊘	⊘				3		⊘
SequencerMode		⊘	⊘			⊘	⊘	⊘	⊘	⊘	⊘	⊘	

Empty	Can be used together
⊘	Cannot be used together
⚠	Configurable, but may not work as expected.
1	When <a href="#">ROICentered</a> is set to <b>On</b> , <a href="#">OffsetX</a> will be disabled.
2	When using <a href="#">Image Scaling Mode (Xscale)</a> together with the <a href="#">ROI Function (Single ROI)</a> , first, set the <a href="#">Width</a> , <a href="#">Height</a> , <a href="#">OffsetX</a> , and <a href="#">OffsetY</a> settings, and then configure the <a href="#">Image Scaling Mode</a> settings.
3	To set <a href="#">Overlay Mode</a> to <b>MultRoiAreaMode</b> , <a href="#">MultiRoiMode (MultiROIControl)</a> must be set to <b>Off</b> in advance.



## Setting List (Feature Properties)

This camera complies with GenICam. Each setting item name conforms to GenICam SFNC (Standard Features Naming Convention). (There are some JAI-specific setting items).

Each setting item is an integer type (Integer), a real type (Float), an element enumeration type (Enumeration), a character string (String), a logical type (Boolean), and a category type (Category) or a command type (Command) for executing the function.

**Beginner:** For beginner users.

**Expert:** For users with deep knowledge of camera functions.

**Guru:** For advanced users who make settings, including advanced features that can cause the camera to malfunction if not set correctly.

**Note:** Depending on the setting item, you may need to change visibility. Please switch visibility (Beginner / Expert / Guru) as necessary.

## Selector

A Selector is used to index which instance of the feature is accessed in situations where multiple instances of a feature exist.

### Instance Example:

Each Line-related item (LineSource, LineInverter, etc.) has LineSelector-LineX instances, which can be set or referenced as an index.

Selectors are a feature of element enumeration type (Enumeration) or an integer type (Integer). However, unlike normal configuration items, it is only used to select the instance in the following configuration item.

It does not change the behavior of the camera by changing the value of the selector. Also, the selector may have only one selectable value. In this case, use the selector function only for information purposes. In this document, it is described as SelectedFeature[Selector] according to the description method of GenICam.

In the case of Line Selector with a specific I/O line selected, the description could be as follows.

```
LineSource[LineSelector-LineX] = High
LineInverter[LineSelector-LineX] = False
LineMode[LineSelector-LineX] = Input
LineFormat[LineSelector-LineX] = TTL
```

Generally, selectors only apply to a single category of features. (Example: TriggerSelector only applies to trigger related functions.)

## DeviceControl

Display/configure information related to the device.

DeviceControl Item	Setting Range	Default Value	Description
DeviceScanType	-	0:Areascan	Display the device scan type.
DeviceVendorName	-	"JAI Corporation"	Display the manufacturer name.
DeviceModelName	-	-	Display the model name.
DeviceManufacturerInfo	-	See the possibilities	Display the manufacturer information.
DeviceVersion	-	-	Display the device version.
DeviceFirmwareVersion	-	-	Display the firmware version.
DeviceFpgaVersion			Display the FPGA version.
DeviceSerialNumber	-	-	Display the device ID.
DeviceUserID	Any	-	Set the user ID (16bytes) for the camera.
DeviceSFNCVersionMajor	-	2	Display the SFNC Major version.
DeviceSFNCVersionMinor	-	5	Display the SFNC Minor version.
DeviceSFNCVersionSubMinor	-	0	Display the SFNC Sub-Minor version.
DeviceManifestEntrySelector	1	1	Display the valid XML file information.
DeviceManifestXML MajorVersion	0 ~ 32bit max	0	Display XML file's major version number.
DeviceManifestXML MinorVersion	0 ~ 32bit max	0	Display XML file's minor version number.
DeviceManifestXML SubMinorVersion	0 ~ 32bit max	1	Display XML file's sub-minor version number.
DeviceManifestSchema MajorVersion	0 ~ 32bit max	1	Display XML file's sub-major version number.
DeviceManifestSchema MinorVersion	0 ~ 32bit max	1	Display schema file's minor version number.
DeviceManifest PrimaryURL	-	-	Display the PrimaryURL.
DeviceManifest SecondaryURL	-	-	Display the SecondaryURL.

## User Manual (Ver. 1.3) - Setting List (Feature Properties)

GOX-5105MC-5GE | GOX-8105MC-5GE | GOX-12405MC-5GE | GOX-16205MC-5GE | GOX-20405MC-5GE | GOX-24505MC-5GE

DeviceControl Item	Setting Range	Default Value	Description
DeviceTLType	0:GigEVision (Fixed)	-	Transport Layer type of the device.
DeviceTLVersionMajor	2 (Fixed)	-	Indicates the major version number of the device's Transport Layer.
DeviceTLVersionMinor	0 (Fixed)	-	Indicates the minor version number of the device's Transport Layer.
DeviceTLVersionSubMinor	1 (Fixed)	-	Indicates the sub-minor version number of the device's Transport Layer.
DeviceLinkSelector	0 (Fixed)	0	Select Link.
DeviceLinkSpeed	-	125000000 Bps	Displays the negotiated transmission rate.
DeviceLinkHeartbeatMode	0:Off 1:On	1:On	Enable/Disable Heartbeat mode.
DeviceLinkHeartbeatTimeout	500000 ~ 120000000	3000000	Configure the timeout value for Heartbeat (unit: $\mu$ s). Step: 1000
DeviceStreamChannelCount	1 (Fixed)	-	Display the number of supported stream channels.
DeviceEventChannelCount	1 (Fixed)	-	Display the number of supported message channels.
DeviceCharacterSet	1: UTF8 (Fixed)	-	Display the character encoding.
DeviceReset	-	-	Reset the device. (After the camera receives this command, it returns an ACK response and executes the reset.)
DeviceRegistersEndianness	1:big-endian (Fixed)	-	Display the register's endianness.
DeviceTemperatureSelector	0: Mainboard 1: Sensor 2: FPGA 3: PHY	0: Mainboard	Select the area of the camera's interior for which to display the temperature sensor's reading.  <b>Related Topic:</b> <a href="#">Notes on Supplying Power via PoE</a>
DeviceTemperature	-55 ~ 125	0	Display the internal temperature ( $^{\circ}$ C) of the device specified by DeviceTemperatureSelector.
Timestamp	0 ~ 64bit max	0	Display the timestamp value (ns). Resets to 0 when the signed maximum 64-bit value is exceeded.
TimestampReset	-	-	Forcibly sets the timestamp's count value to 0.
TimestampLatch	-	-	Sets the timestamp's count value to TimestampLatchValue.
TimestampLatchValue	0 ~ 64bit max	0	Maximum value Signed 64-bit max value.

DeviceControl Item	Setting Range	Default Value	Description
UserDefinedValueSelector	0: Value1 1: Value2 2: Value3 3: Value4 4: Value5	0: Value1	Five 32bit data can be set and saved.
UserDefinedValue	-2147483648 ~ 2147483647	0	Selects one of the 32bit data (Value1 to Value5) set in UserDefinedValueSelector, and reads and sets the value in UserDefinedValue.
TemperatureWarningMode	0: Off 1: On	1: On	Enables/disables TemperatureWarningMode.
<b>Related Topic:</b> <a href="#">Temperature Warning Mode</a>			
TemperatureWarningStatus	0: Normal 1: Warning 2: PowerSave 3: StopImage 4: Disconnect	0: Normal	Display the status when TemperatureWarningMode is enabled.

## TransportLayerControl

Display information on transport layer control.

TransportLayerControl Item	Setting Range	Default Value	Description
PayloadSize			Display the payload size. (Include ChunkData) (unit: bytes)
GigEVision			
GevPhysicalLinkConfiguration	-	0:Single Link (Fixed)	Display the LinkConfiguration status.

## User Manual (Ver. 1.3) - Setting List (Feature Properties)

GOX-5105MC-5GE | GOX-8105MC-5GE | GOX-12405MC-5GE | GOX-16205MC-5GE | GOX-20405MC-5GE | GOX-24505MC-5GE

TransportLayerControl Item	Setting Range	Default Value	Description	
GevSupportedOptionSelector	-	0: SingleLink	Select the supported options for GigE Vision.	
			Link Configuration	0: SingleLink
			nif Configuration	4:PAUSEFrameReception, 5:PAUSEFrameGeneration, 6:IPConfigurationLLA, 7:IPConfigurationDHCP, 8:IPConfigurationPersistentIP
			GVCP	11:MessageChannelSourceSocket, 12:CommandsConcatenation, 13:WriteMem, 14:PacketResend, 15:Event, 17:PendingAck, 18:IEEE1588, 19:Action, 21:ScheduledAction, 23:ExtendedStatusCodes, 24:ExtendedStatusCodesVersion2_0, 28:ManifestTable, 29:CCPApplicationSocket, 30:LinkSpeed, 31:HeartbeatDisable, 32:SerialNumber, 33:UserDefinedName
GVSP	9:StreamChannelSourceSocket, 10:StandardIDMode			
GevSupportedOption	-	-	Displays whether the function selected by GevSupportOptionSelector is supported or not.	
GevInterfaceSelector		0: (Fixed)		
GevMACAddress	-	-	Display the MAC address.	
GevPAUSEFrameReception	-	1: TRUE (Fixed)		
GevPAUSEFrameTransmission	-	1: TRUE (Fixed)		
GevCurrentIPConfiguration LLA	-	1: TRUE (Fixed)	Display whether the current IP configuration is calibrated by LLA (link-local address).	
GevCurrentIPConfiguration DHCP	0: False 1: True	1: TRUE	Select whether to set the IP configuration to DHCP.	
GevCurrentIPConfiguration PersistentIP	0: False 1: True	0: FALSE	Select whether to set the IP configuration to Persistent IP.	

## User Manual (Ver. 1.3) - Setting List (Feature Properties)

GOX-5105MC-5GE | GOX-8105MC-5GE | GOX-12405MC-5GE | GOX-16205MC-5GE | GOX-20405MC-5GE | GOX-24505MC-5GE

TransportLayerControl Item	Setting Range	Default Value	Description
GetCurrentIPAddress	-	-	Display the IP address.
GetCurrentSubnetMask	-	-	Display the subnet.
GetCurrentDefaultGateway	-	-	Display the default gateway.
GetIPConfigurationStatus	-	2:DHCP	Display the current IP configuration status. <b>Setting Range:</b> 0:None , 1:PersistentIP, 2:DHCP, 3:LLA, 4:ForceIP
GetPersistentIPAddress	-	192.168.0.100	Set the persistent IP address.
GetPersistentSubnetMask	-	255.255.255.0	Set the persistent subnet mask.
GetPersistentDefaultGateway	-	0.0.0.0	Set the persistent default gateway.
NetworkThroughput SafetyMargin	10 - 100	92	For the configured LinkSpeed, set the limit to the bandwidth of the stream out of the camera (%).  <b>Caution:</b> You can increase the frame rate by increasing this value. However, when set to more than 92 (default), abnormal images may be observed depending on the PC and its environment. If this happens, set the value to the default value (92).
GetIEEE1588  <b>Related Topic:</b> <a href="#">PTP (Precision Time Protocol)</a>	0: False 1: True	0: FALSE	TRUE : Enables PTP FALSE: Disables PTP
GetIEEE1588ClockAccuracy	0 -20	19:Unknown	Indicates clock accuracy. <b>Setting Range:</b> 0:Within25ns, 1:Within100ns, 2:Within250ns, 3:Within1us, 4:Within2p5u, 5:Within10us, 6:Within25us, 7:Within100us, 8:Within250us, 9:Within1ms, 10:Within2p5ms, 11:Within10ms, 12:Within25ms, 13:Within100ms, 14:Within250ms, 15:Within1s, 16:Within10s, 17:GreaterThan10s, 18:AlternatePTPProfile, 19:Unknown, 20:Reserved
GetIEEE1588Status	-	-	Display the IEEE 1588 Status. 1:initializing, 2:faulty, 3:disabled, 4:listening, 5:preMaster, 6:master, 7:passive, 8:uncalibrated, 9:slave

## User Manual (Ver. 1.3) - Setting List (Feature Properties)

GOX-5105MC-5GE | GOX-8105MC-5GE | GOX-12405MC-5GE | GOX-16205MC-5GE | GOX-20405MC-5GE | GOX-24505MC-5GE

TransportLayerControl Item	Setting Range	Default Value	Description
GevGVCPExtendedStatusCodesSelector	0:Version1_1 1:Version2_0	0:Version1_1	Select the GevGVCPExtendedStatusCodes.
GevGVCPExtendedStatusCodes	-	-	Enables the generation of extended status codes.
GevGVCPPendingAck <a href="#">Step 6: Adjust the Image Quality</a>	0: Off 1: On	0: Off	Enables/disables the PENDING_ACK.
GevGVSPExtendedIDMode	0: Off 1: On	0: Off	Enables/disables Extended ID Mode.
GevCCP	0 ~ 2	0:OpenAccess	Control access rights.  <b>0:OpenAccess</b> - Access rights have not been obtained by the application. <b>1:ExclusiveAccess</b> - Once the application has made this setting, no other applications can control or reference the camera. <b>2:ControlAccess</b> - Access rights have been obtained by the application. Other applications cannot control the camera, but can refer to it.
GevPrimaryApplicationSocket	-	-	Returns the UDP source port of the primary application.
GevPrimaryApplicationIPAddress	-	-	Returns the address of the primary application.
GevMCPHostPort	-	-	Controls the port to which the device must send messages. Setting this value to 0 closes the message channel.
GevMCDA	-	-	Controls the destination IP address for the message channel.
GevMCTT	0~ 4294967295 (ms)	0	Display/set the Transmission Timeout for Message Channel. (ACK is not used for Message on this camera, so this setting has no effect).
GevMCRC	0~ 4294967295	0	Display/set the Retry Count for Message Channel. (ACK is not used for Message on this camera, so this setting has no effect).
GevMCSP	-	-	This feature indicates the source port for the message channel.
GevStreamChannelSelector	0	0	Selects the stream channel to control.

## User Manual (Ver. 1.3) - Setting List (Feature Properties)

GOX-5105MC-5GE | GOX-8105MC-5GE | GOX-12405MC-5GE | GOX-16205MC-5GE | GOX-20405MC-5GE | GOX-24505MC-5GE

TransportLayerControl Item	Setting Range	Default Value	Description
GevSCCFGPacketResendDestination	0: False 1: True	0: FALSE	Enables the alternate IP destination for stream packets resent due to a packet resend request.
GevSCCFGAllInTransmission	0: False 1: True	0: FALSE	Enables the selected GVSP transmitter to use the single packet per data block All-in Transmission mode.
GevSCCFGUnconditionalStreaming	0: False 1: True	0: FALSE	Enables the camera to continue to stream, for this stream channel, if its control channel is closed or regardless of the reception of any ICMP messages (such as destination unreachable messages).
GevSCCFGExtendedChunkData	0: False 1: True	0: FALSE	Enables cameras to use the extended chunk data payload type for this stream channel.
GevSCPIInterfaceIndex	0	0 (Fixed)	Index of the logical link to use.
GevSCPHostPort	-	-	Controls the port of the selected channel to which a GVSP transmitter must send data stream or the port from which a GVSP receiver may receive a data stream. Setting this value to 0 closes the stream channel.
GevSCPSFireTestPacket	-	-	Sends a test packet. When this feature is set, the device will fire one test packet.
GevSCPSDoNotFragment	0: False 1: True	1: TRUE	The state of this feature is copied into the "do not fragment" bit of IP header of each stream packet. It can be used by the application to prevent IP fragmentation of packets on the stream channel.
GevSCPSPacketSize	1476 ~ 12036	1476	Specify the SCPS packet size (bytes).
GevSCPD	-	0	Controls the delay (in GEV timestamp counter unit) to insert between each packet for this stream channel. (step 8) Min: 0 Max: The value depends on the PixelFormat, Width, GevGVSPExtendedIDMode, GevSCPSPacketSize, NetworkThroughputSafetyMargin settings.
GevSCDA	-	-	Controls the destination IP address of the selected stream channel to which a GVSP transmitter must send data stream or the destination IP address from which a GVSP receiver may receive data stream.
GevSCSP	-	-	Indicates the source port of the stream channel.
NetworkStatistics	-	-	Category containing statistics about the different modules of the GigE Vision transport layer.



TransportLayerControl Item	Setting Range	Default Value	Description
oMACControlFunctionEntity	-	-	Category containing statistics related to the device's MAC control PAUSE function.
aPAUSEMACCtrlFrames Received	0 ~ 32bit max	0	Displays the number of Pause frames received.

## ImageFormatControl

Configure image format settings.

**Note:** Refer to [Functions That Cannot Be Used Together](#) for usage restrictions.

Image Format Control Item	Setting Range	Default Value	Description
SensorWidth			Display the maximum image width.  GOX-5105MC-5GE: 2472 GOX-8105MC-5GE: 2856 GOX-12405MC-5GE: 4128 GOX-16205MC-5GE: 5328 GOX-20405MC-5GE: 4512 GOX-24505MC-5GE: 5328
SensorHeight			Display the maximum image height.  GOX-5105MC-5GE: 2064 GOX-8105MC-5GE: 2848 GOX-12405MC-5GE: 3008 GOX-16205MC-5GE: 3040 GOX-20405MC-5GE: 4512 GOX-24505MC-5GE: 4608
WidthMax			Display the maximum image width.  GOX-5105MC-5GE:2472 (1236) GOX-8105MC-5GE: 2856 (1428) GOX-12405MC-5GE: 4128 (2064) GOX-16205MC-5GE: 5328 (2664) GOX-20405MC-5GE: 4512 (2256) GOX-24505MC-5GE: 5328 (2664)  <b>Note:</b> For monochrome models, when BinningHorizontal = 2 or FD2x2BinningMode = On, the value in parenthesis is applicable.

Image Format Control Item	Setting Range	Default Value	Description
HeightMax			<p>Display the maximum image height.</p> <p>GOX-5105MC-5GE: 2064 (1032)                      GOX-8105MC-5GE: 2848 (1424)                      GOX-12405MC-5GE: 3008 (1504)                      GOX-16205MC-5GE: 3040 (1520)                      GOX-20405MC-5GE: 4512 (2256)                      GOX-24505MC-5GE: 4608 (2304)</p> <p><b>Note:</b> For monochrome models, when BinningVertical = 2 or FD2x2BinningMode = On, the value in parenthesis is applicable.</p>
Width  <b>Related Topic:</b> <a href="#">ROI Function (Single ROI)</a>	-	WidthMax value	<p>Set the image width.</p> <p><b>Note:</b> This setting is available only when ImageScalingMode=Off.</p> <p>Setting Range: 96 (48)* ~ [WidthMax - OffsetX] , Step 8(4)*</p> <p>*For monochrome models, when BinningHorizontal = 2 or FD2x2BinningMode = On, the value in parentheses is applicable.</p>
Height  <b>Related Topic:</b> <a href="#">ROI Function (Single ROI)</a>	-	HeightMax value	<p>Set the image height.</p> <p><b>Note:</b> This setting is available only when ImageScalingMode=Off.</p> <p>Setting Range: 8 (4)* ~ [HeightMax - OffsetY], Step 2(1)*</p> <p>*For monochrome models, when BinningVertical = 2 or FD2x2BinningMode = On, the value in parentheses is applicable.</p>
OffsetX  <b>Related Topic:</b> <a href="#">ROI Function (Single ROI)</a>	-	0	<p>Set the horizontal offset.</p> <p><b>Note:</b> This setting is available only when ImageScalingMode=Off.</p> <p>Setting Range: 0 ~ [WidthMax - Width], Step 8(4)*</p> <p>*For monochrome models, when BinningHorizontal = 2 or FD2x2BinningMode = On, the value in parentheses is applicable.</p>

## User Manual (Ver. 1.3) - Setting List (Feature Properties)

GOX-5105MC-5GE | GOX-8105MC-5GE | GOX-12405MC-5GE | GOX-16205MC-5GE | GOX-20405MC-5GE | GOX-24505MC-5GE

Image Format Control Item	Setting Range	Default Value	Description
OffsetY  <b>Related Topic:</b> <a href="#">ROI Function (Single ROI)</a>	-	0	Set the vertical offset.  <div style="border: 1px solid gray; padding: 2px;"> <b>Note:</b> This setting is available only when ImageScalingMode=Off.           </div> Setting Range: 0 ~ [HeightMax - Height], Step 2(1)*  *For monochrome models, when BinningVertical = 2 or FD2x2BinningMode = On, the value in parentheses is applicable.
ROICentered  <b>Related Topic:</b> <a href="#">ROICentered</a>	0: Off 1: On	0: Off	When set to On, the image output position in the X direction is always forced to be centered and OffsetX is disabled.
FD2x2BinningMode  <b>Related Topic:</b> <a href="#">Binning Function</a>	0:Off 1:On	0:Off	Performs 2x2 analog binning (Sum processing). Monochrome models only.
BinningHorizontalMode  <b>Related Topic:</b> <a href="#">Binning Function</a>	0:Sum 1:Average	0:Sum	Set the processing method for horizontal binning. Monochrome models only.
BinningHorizontal	1 ~ 2	1	Set the number of pixels in the horizontal direction for which to perform binning.  Monochrome models only.
BinningVerticalMode  <b>Related Topic:</b> <a href="#">Binning Function</a>	0:Sum 1:Average	0:Sum	Set the processing method for vertical binning. Monochrome models only.
BinningVertical	1 ~ 2	1	Set the number of pixels in the vertical direction for which to perform binning. Monochrome models only.
ImageScalingMode  <b>Related Topic:</b> <a href="#">Image Scaling Mode (Xscale)</a>	0:Off 1:On	0:Off	Enables Image Scaling Mode.
ImageScalingSumMode	0:Off (Ave) 1:On (Sum)	0:Off (Ave)	Selects whether to use Sum or Average mode when ImageScalingMode is On.

Image Format Control Item	Setting Range	Default Value	Description
ImageScalingHorizontal	0.0625 ~ 1	1	Specifies the horizontal scaling ratio in decimal units. For example, if you want to scale the image by 50% in the horizontal direction, specify "0.5".
ImageScalingHorizontalAbs	256 ~ 4096	-	Indicates the horizontal scaling ratio as an integer value (rounded down to the nearest whole number). The formula is: ImageScalingHorizontal X 4096.
ImageScalingVertical	0.0625 ~ 1	1	Specifies the vertical scaling ratio in decimal units. For example, if you want to scale the image by 50% in the vertical direction, specify "0.5".
ImageScalingVerticalAbs	256 ~ 4096	-	Indicates the vertical scaling ratio as an integer value (rounded down to the nearest whole number). The formula is: ImageScalingVertical X 4096.
ImageScalingBaseAbs	-	4096 (Fixed)	
DecimationHorizontalMode	-	0: Discard (Fixed)	Set Decimation Horizontal mode.
DecimationHorizontal  <b>Related Topic:</b> <a href="#">Decimation Mode</a>	-	1: None	If set to 2, Pixels(50%) are thinned out horizontally.  1: None 2: Pixels are thinned out horizontally  <b>Note:</b> DecimationHorizontal and DecimationVertical cannot be set separately. For example, changing DecimationHorizontal to 2 will automatically change DecimationVertical to 2.
DecimationVerticalMode	-	0: Discard (Fixed)	Set Decimation Vertical mode.
DecimationVertical  <b>Related Topic:</b> <a href="#">Decimation Mode</a>	-	1: None	If set to 2, Pixels(50%) are thinned out vertically.  1: None 2: Pixels are thinned out vertically.  <b>Note:</b> DecimationHorizontal and DecimationVertical cannot be set separately. For example, changing DecimationHorizontal to 2 will automatically change DecimationVertical to 2.

## User Manual (Ver. 1.3) - Setting List (Feature Properties)

GOX-5105MC-5GE | GOX-8105MC-5GE | GOX-12405MC-5GE | GOX-16205MC-5GE | GOX-20405MC-5GE | GOX-24505MC-5GE

Image Format Control Item	Setting Range	Default Value	Description
ReverseX  <b>Related Topic:</b> <a href="#">Image Flip Function</a>	0: Off 1: On	0: Off	Reverse pixels horizontally.
ReverseY	0: Off 1: On	0: Off	Reverse pixels vertically.
ReverseXY	0: Off 1: On	0: Off	Reverse the current ReverseX and ReverseY settings.
SensorDigitizationBits  <b>Related Topic:</b> <a href="#">SensorDigitizationBits</a>	8: 8 Bits 10: 10 Bits 12: 12 Bits	10: 10 Bits	Select the sensor output bits.

Image Format Control Item	Setting Range	Default Value	Description
<p>PixelFormat</p> <p><b>Related Topic:</b> <a href="#">Pixel Format</a></p>	-	<p>BayerRG8</p> <p>Mono8</p>	<p>Set the pixel format.</p> <p><b>Color Models</b></p> <p>0x01080009: BayerRG8 (Default)</p> <p>0x0110000D: BayerRG10</p> <p>0x010C0027: BayerRG10Packed</p> <p>0x01100011: BayerRG12</p> <p>0x010C002B: BayerRG12Packed</p> <p>0x01080008: BayerGR8*</p> <p>0x0110000C: BayerGR10*</p> <p>0x010C0026: BayerGR10Packed*</p> <p>0x01100010: BayerGR12*</p> <p>0x010C002A: BayerGR12Packed*</p> <p>0x0108000A: BayerGB8*</p> <p>0x0110000E: BayerGB10*</p> <p>0x10C0028: BayerGB10Packed*</p> <p>0x01100012: BayerGB12*</p> <p>0x010C002C: BayerGB12Packed*</p> <p>0x0108000B: BayerBG8*</p> <p>0x0110000F: BayerBG10*</p> <p>0x010C0029: BayerBG10Packed*</p> <p>0x01100013: BayerBG12*</p> <p>0x010C002D: BayerBG12Packed*</p> <p>0x02180014: RGB8**</p> <p>0x0220001C: RGB10V1Packed**</p> <p>0x0220001D: RGB10p32**</p> <p><b>Notes:</b></p> <ul style="list-style-type: none"> <li>• *When using the <a href="#">Image Flip Function</a>.</li> <li>• Utilize 5x5 Debayering</li> </ul> <p><b>Monochrome Models</b></p> <p>0x01080001: Mono8 (Default)</p> <p>0x01100003: Mono10</p> <p>0x010C0004: Mono10Packed</p> <p>0x01100005: Mono12</p> <p>0x010C0006: Mono12Packed</p>

## User Manual (Ver. 1.3) - Setting List (Feature Properties)

GOX-5105MC-5GE | GOX-8105MC-5GE | GOX-12405MC-5GE | GOX-16205MC-5GE | GOX-20405MC-5GE | GOX-24505MC-5GE

Image Format Control Item	Setting Range	Default Value	Description
GradationCompression Mode <b>Related Topic:</b> <a href="#">Gradation Compression Mode</a>	0: Off 1: On	0: Off	Enables the sensor's gradation compression function.
GradationCompression 1stKneePoint	-	50	Set the first knee point of the sensor's gradation compression function in percentage. Setting Range (%): 0, 6.25, 12.5, 25, 50, 100 Max Value: 0 or the GradationCompression2ndKneePoint value, whichever is smaller.
GradationCompression 1stGain	-	0	Set the first knee compression rate for the sensor's gradation compression function in dB. Setting Range (dB): 0, -6, -12, -18, -24, -30, -36, -42, -48, -54, -60, -66
GradationCompression 2ndKneePoint	-	100	Set the second knee point of the sensor's gradation compression function in percentage. Setting Range (%): 6.25, 12.5, 25, 50, 100, 200, 400, 800 Min Value: GradationCompression1stKneePoint. However, when GradationCompression1stKneePoint is set to 0, Min = 6.25
GradationCompression 2ndGain	-	0	Set the second knee compression rate for the sensor's gradation compression function in dB. Setting Range (dB): 0, -6, -12, -18, -24, -30, -36, -42, -48, -54, -60, -66
TestPattern	-	0: Off	Select the test image. 0: Off (Default) 1: GreyHorizontalRamp 4: HorizontalColorBar (Color models only)
OverlayMode <b>Related Topic:</b> <a href="#">Overlay Mode</a>	-	0: Off	You can check the target area by reducing the brightness of the non-target area to 50%. 0: Off (Default) 1: MultiRoiAreaMode - Check the active area on MultiROI. 2: ALCAreaMode - Check the photometry area on ALC. 3: AWBAreaMode - Check the photometry area on AWB.

## MultiROIControl

Configure settings for Multi ROI.

**Related Topic:** [ROI Function \(Multi ROI\)](#)

**Note:** Refer to [Functions That Cannot Be Used Together](#) for usage restrictions.

Multi ROI Control Item	Setting Range	Default Value	Description
MultiRoiMode	0:Off 1:On	0	Enable/disable Multi Roi.
MultiRoiIndex	0 ~ 7	0	Select the index for the Multi Roi mode.
MultiRoiWidth	-	-	Set the width for the selected Multi Roi index. Setting Range: 96 ~ [WidthMax - MultiRoiOffsetX], Step 8 <b>Default</b> GOX-5105MC-5GE: 304 GOX-8105MC-5GE: 352 GOX-12405MC-5GE: 512 GOX-16205MC-5GE: 664 GOX-20405MC-5GE: 560 GOX-24505MC-5GE: 664
MultiRoiHeight	-	-	Set the height for the selected Multi Roi index. Setting Range: 8 ~ [HeightMax - MultiRoiOffsetY], Step 2 <b>Default</b> GOX-5105MC-5GE: 258 GOX-8105MC-5GE: 356 GOX-12405MC-5GE: 376 GOX-16205MC-5GE: 380 GOX-20405MC-5GE: 564 GOX-24505MC-5GE: 576
MultiRoiOffsetX	-	-	Set the horizontal offset for the selected Multi Roi index. <b>Min:</b> The minimum value of the range where each Index does not overlap. <b>Max:</b> The maximum value of the range where each Index does not overlap. <b>Step:</b> 8 <b>Default:</b> (Index number - 1) x MultiRoiWidth



## User Manual (Ver. 1.3) - Setting List (Feature Properties)

GOX-5105MC-5GE | GOX-8105MC-5GE | GOX-12405MC-5GE | GOX-16205MC-5GE | GOX-20405MC-5GE | GOX-24505MC-5GE

Multi ROI Control Item	Setting Range	Default Value	Description
MultiRoiOffsetY	-	-	<p>Set the vertical offset for the selected Multi Roi index.</p> <p><b>Min:</b> The minimum value of the range where each Index does not overlap.</p> <p><b>Max:</b> The maximum value of the range where each Index does not overlap.</p> <p><b>Step:</b> 2</p> <p><b>Default:</b> (Index number - 1) x MultiRoiHeight</p>
MultiRoiHorizontal EnableNumber	1 ~ 8	1	Set the maximum number of valid horizontal index numbers.
MultiRoiVertical EnableNumber	1 ~ 8	1	Set the maximum number of valid vertical index numbers.

## AcquisitionControl

Configure image capture settings.

Acquisition Control Item	Setting Range	Default Value	Description
AcquisitionMode  <b>Related Topic:</b> <a href="#">Acquisition Control</a>	0:SingleFrame 1:MultiFrame 2:Continuous	2:Continuous	Select the image capture mode.
AcquisitionStart	-	-	Start image capture.
AcquisitionStop	-	-	Stop image capture.
AcquisitionFrameCount	1 ~ 65535	1	In MultiFrame mode, set the number of frames to capture.
AcquisitionFrameRate  <b>Related Topic:</b> <a href="#">Changing the Frame Rate</a>	0.125 ~	-	<p>Display the frame rate as a frequency (unit: Hz). The maximum value varies depending on the Width, Height, PixelFormat, SensorDigitizationBits, Binning(Horizontal/Vertical), FD2x2BinningMode, ImageScalingMode, Decimation (Horizontal/Vertical), ChunkModeActive, GevSCSPPacketSize, GevSCPD, NetworkThroughputSafetyMargin settings.</p> <p><b>Default</b></p> <p>GOX-5105MC-5GE: 98 fps            GOX-8105MC-5GE: 62 fps            GOX-12405MC-5GE: 41 fps            GOX-16205MC-5GE: 32 fps            GOX-20405MC-5GE: 25 fps            GOX-24505MC-5GE: 21 fps</p> <p><b>Notes:</b></p> <ul style="list-style-type: none"> <li>• Default: the fastest FPS value when set to: SensorDigitizationBits = 10bit, PixelFormat = 8bit., NetworkThroughputSafetyMargin = 92, PacketSize = 1476 Byte, ExtendedIDMode = Off.</li> <li>• See <a href="#">Features</a> for the frame rates when <b>PacketSize</b> is set to <b>12036</b>.</li> <li>• See <a href="#">Notes on Supplying Power via PoE</a> for the frame rate restriction when using the PoE power supply.</li> </ul>

## User Manual (Ver. 1.3) - Setting List (Feature Properties)

GOX-5105MC-5GE | GOX-8105MC-5GE | GOX-12405MC-5GE | GOX-16205MC-5GE | GOX-20405MC-5GE | GOX-24505MC-5GE

Acquisition Control Item	Setting Range	Default Value	Description
TriggerSelector <b>Related Topic:</b> <a href="#">Trigger Control</a>	0:AcquisitionStart 1:AcquisitionEnd 2:FrameStart 3:Acquisition TransferStart	0:AcquisitionStart	Select the trigger operation.
TriggerMode	0:Off 1:On	0:Off	Select the trigger mode.
TriggerSoftware	-	-	Execute a software trigger.
TriggerSource	-	24: Line5 Opt In	Select the trigger signal source.  7-10: PulseGenerator0-3 11-14: UserOutput0 -3 15-18: Action0-3 19:Software 24: Line5 Opt In 36: Nand0 Out 37: Nand1 Out
TriggerActivation	1:Rising Edge 2:Falling Edge 3:Level High 4:Level Low	1:Rising Edge	Select the polarity of the trigger signal (i.e., location of signal at which trigger is applied).
TriggerOverlap	0: Off (fixed) 1: ReadOut	-	Select the trigger overlap operation.  TriggerSelector (AcquisitionStart/AcquisitionEnd/AcquisitionTransferStart) = 0:Off (Fixed) TriggerSelector(FrameStart) = 1: ReadOut
TriggerDelay	0 - 500000	0	Set the time of exposure start from trigger input. (unit: $\mu$ s)
ExposureMode <b>Related Topic:</b> <a href="#">Exposure Mode</a>	0: Off 1: Timed 2: TriggerWidth	1: Timed	Select the exposure mode.

## User Manual (Ver. 1.3) - Setting List (Feature Properties)

GOX-5105MC-5GE | GOX-8105MC-5GE | GOX-12405MC-5GE | GOX-16205MC-5GE | GOX-20405MC-5GE | GOX-24505MC-5GE

Acquisition Control Item	Setting Range	Default Value	Description
ExposureTime (us)  <b>Related Topic:</b> <a href="#">Actual Exposure Time</a>	-	-	<p>Set the exposure time (us).</p> <p><b>Note:</b> The actual exposure time will consist of the image sensor's offset duration (2.45us) added to the ExposureTime setting.</p> <p><b>Min:</b> 1 <b>Max:</b> (1/AcquisitionFrameRateMax) - Next trigger prohibited time. <b>Default:</b> GOX-5105MC-5GE: 9853 GOX-8105MC-5GE: 15615 GOX-12405MC-5GE: 23745 GOX-16205MC-5GE: 30896 GOX-20405MC-5GE: 38470 GOX-24505MC-5GE: 46356</p>
ExposureAuto	0: Off 1: Once 2: Continuous	0: Off	<p>Set whether to enable auto exposure.</p> <p>When set to Once, the automatic adjustment will be performed only once, and then automatically switched to Off.</p>
ExposureModeOption	0: Off 1: RCT	0: Off	<p>Enables RCT mode.</p> <p><b>Related Topic:</b> <a href="#">RCT Mode</a></p>

## DigitalIOControl

Configure settings for digital input/output.

**Related Topic:** [GPIO \(Digital Input/Output Settings\)](#)

Digital IO Control Item	Setting Range	Default Value	Description
LineSelector	-	21: Line2 Opt Out1	Select the input/output to configure. 21: Line2 Opt Out1 24: Line5 Opt In1 53: Nand0 In1 54: Nand0 In2 55: Nand1 In1 56: Nand1 In2 63: TimestampReset
LineMode	-	-	Display the input/output status (whether it is input or output). 0: Input (LineSelector=24,53,54,55,56) 1: Output (LineSelector=21) 2: InternalConnection (LineSelector=63)
LineInverter	0: False 1: True	0: False	Enable/disable polarity inversion for the selected input signal or output signal. <b>Note:</b> LineSelector=24,63 are fixed to "0".
LineStatus	0: False 1: True	0: False	Display the status of the input signal or output signal (True: High, False: Low).

## User Manual (Ver. 1.3) - Setting List (Feature Properties)

GOX-5105MC-5GE | GOX-8105MC-5GE | GOX-12405MC-5GE | GOX-16205MC-5GE | GOX-20405MC-5GE | GOX-24505MC-5GE

Digital IO Control Item	Setting Range	Default Value	Description
LineSource	-	-	<p>Select the line source signal for the item selected in LineSelector.</p> <p>0: Off (Only when LineSelector is set to TimestampReset)            1: AcquisitionActive            2: FrameActive            4: ExposureActive            5: FVAL            7-10: PulseGenerator0-3            11-14: UserOutput0-3            15-18: Action0-3 (only when LineSelector=TimestampReset)            24: Line5 Opt In1            36: Nand0 Out            37: Nand1 Out            40: - (Not selectable for Output and NAND In)            41: Low            42: High            43: AcquisitionTriggerWait            44: FrameTriggerWait</p> <p>※LineSelector=24 is fixed to "-".</p> <p><b>Default</b>            LineSelector=TimestampReset: Off(0)            LineSelector=Other than TimestampReset: Line5 Opt In1 (24)</p>
LineFormat	-	-	<p>Display the signal format.</p> <p>2: TTL            5: OptoCoupled            7: Internal Signal</p> <p><b>Default</b>            LineSelector=21,24: OptoCoupled            LineSelector=53,54,55,56,63: Internal Signal</p>
LineStatusAll	-	-	<p>Display the input/output signal status. The state is shown with 16 bits. Bit assignments are as follows.</p> <p>bit0: Unused (Fixed to 0)            bit1: Line2            bit2 - 3: Unused (Fixed to 0)            bit4: Line5            bit5 - 11: Unused (Fixed to 0)            bit12: Nand0 In1            bit13: Nand0 In2            bit14: Nand1 In1            bit15: Nand1 In2</p>

Digital IO Control Item	Setting Range	Default Value	Description
OptInFilter (ns)	0 ~ 40000000	0	Remove noise from the OptIn input signal of Digital I/O. Step: 100 Setting Range: 0 ~ 40ms
UserOutput Selector	-	0: User Output 0	Set the UserOutput signal. 0: User Output 0 1: User Output 1 2: User Output 2 3: User Output 3
UserOutput Value	0: False 1: True	0: False	Set the value for the UserOutput selected in UserOutputSelector.

## PulseGenerator

Configure pulse generator settings.

**Related Topic:** [Pulse Generator](#)

Pulse Generator Item	Setting Range	Default Value	Description
ClockPreScaler	1 ~ 4096	297	Set the division value for the prescaler (12 bit) using PixelClock as the base clock.
PulseGeneratorClock (MHz)	-	0.25	Set the clock used for the pulse generator. This value is calculated using the [ClockPreScaler] value as a base. PulseGeneratorClock = SrcFreq / ClockPreScaler SrcFreq:74.25
PulseGeneratorSelector	0:PulseGenerator0 1:PulseGenerator1 2:PulseGenerator2 3:PulseGenerator3	0:PulseGenerator0	Select the pulse generator.
PulseGeneratorLength	1 ~ 1048575	25000	Set the maximum count-up value as a clock count.
PulseGeneratorLengthMs (ms)	-	100	Set the maximum count-up value in milliseconds. This value is calculated using the PulseGeneratorLength value as a base. The setting range varies depending on the ClockPreScaler value. PulseGeneratorLengthMs = 1/PulseGeneratorClock * PulseGeneratorLength

## User Manual (Ver. 1.3) - Setting List (Feature Properties)

GOX-5105MC-5GE | GOX-8105MC-5GE | GOX-12405MC-5GE | GOX-16205MC-5GE | GOX-20405MC-5GE | GOX-24505MC-5GE

Pulse Generator Item	Setting Range	Default Value	Description
PulseGeneratorFrequency (Hz)	-	10	Set the maximum count-up value as a frequency.  This value is calculated using the PulseGeneratorLength value as a base.  $\text{PulseGeneratorFrequency} = 1\text{sec} / \text{PulseGeneratorLengthMs}$
PulseGeneratorStartPoint	0 ~ 1048575	0	Set the start point of the High interval as a clock count. When the counter reaches this value, the output will be 1.
PulseGeneratorStartPointMs (ms)	-	0	Set the start point of the High interval in milliseconds. When the counter reaches this value, the output will be 1. The setting range varies depending on the ClockPreScaler value.  $\text{PulseGeneratorStartPointMs} = 1 / \text{PulseGeneratorClock} * \text{PulseGeneratorStartPoint}$
PulseGeneratorEndPoint	1 ~ 1048575	12500	Set the start point of the Low interval as a clock count. When the counter reaches this value, the output will be 0.
PulseGeneratorEndPointMs (ms)	-	50	Set the start point of the Low interval in milliseconds. When the counter reaches this value, the output will be 0. The setting range varies depending on the ClockPreScaler value.  $\text{PulseGeneratorEndPointMs} = 1 / \text{PulseGeneratorClock} * \text{PulseGeneratorEndPoint}$
PulseGeneratorPulseWidth (ms)	-	50	Display the High interval width of the pulse in milliseconds. The duration between the Start Point and End Point is calculated. The setting range varies depending on the ClockPreScaler value.  $\text{PulseGeneratorPulseWidth} = 1 / \text{PulseGeneratorClock} * (\text{PulseGeneratorEndPoint} - \text{PulseGeneratorStartPoint})$
PulseGeneratorRepeat Count	0 ~ 255	0	Set the repeat count for the counter. When this is set to 0, a free counter is enabled with no repeat limit.
PulseGeneratorClear Activation	0: Off 1: Rising Edge 2: Falling Edge 3: Level High 4: Level Low	0: Off	Set the clear signal condition for the count clear input of the pulse generator.



## User Manual (Ver. 1.3) - Setting List (Feature Properties)

GOX-5105MC-5GE | GOX-8105MC-5GE | GOX-12405MC-5GE | GOX-16205MC-5GE | GOX-20405MC-5GE | GOX-24505MC-5GE

Pulse Generator Item	Setting Range	Default Value	Description
PulseGeneratorClear Source	-	24: Line5 Opt In1	<p>Select the count clear input signal source.</p> <p>1: AcquisitionActive            2: FrameActive            4: ExposureActive            5: FVAL            7-10: PulseGenerator0-3(*)            11-14: UserOutput0-3            24: Line5 Opt In1            36: Nand0 Out            37: Nand1 Out            43: AcquisitionTriggerWait            44: FrameTriggerWait</p> <p><b>Note:</b> (*)Disabled if the PulseGenerator is selected in PUlseGeneratorSelector.</p>
PulseGeneratorClear SyncMode	0:Async Mode 1:Sync Mode	0:Async Mode	Select the sync mode for the count clear input signal.

# AnalogControl

Configure the analog control settings.

Analog Control Item	Setting Range	Default Value	Description
GainSelector  <b>Related Topic:</b> <a href="#">Gain Control</a>	0: Analog All 1: Digital Red 3: Digital Blue	0:Analog All	Select the gain to configure.  <b>Note:</b> DigitalRed and DigitalBlue are available only for color models.
Gain	-	1	Set the gain value for the gain setting selected in GainSelector.  <b>Note:</b> DigitalRed and DigitalBlue are available only for color models.  Unit:Magnification <b>AnalogAll:</b> Min=1.0, Max=126.0 , Step= 0.1dB <b>DigitalRed/DigitalBlue:</b> Min=0.447, Max=5.624, Step=0.000122 (Color model only)
GainAuto	0: Off 1: Once 2: Continuous	0: Off	Enable/disable gain auto adjustment. Once automatically changes to Off when the signal level converges once.
BlackLevelSelector	0: All 1: Red 3: Blue	0: All	Select the black level to configure.  <b>Note:</b> DigitalRed and DigitalBlue are available only for color models.
BlackLevel	-	0	Set the black level value.  <b>All:</b> Min=-133, Max=255 <b>Red:</b> Min=-64, Max=64 <b>Blue:</b> Min=-64, Max=64  <b>Note:</b> Red and Blue are available only for color models.

Analog Control Item	Setting Range	Default Value	Description
BalanceWhiteAuto	-	0: Off	<p>Enable/disable auto white balance. When set to Once, the automatic adjustment will be performed only once, and then automatically switched to Off.</p> <p><b>Note:</b> Color models only.</p> <p>0: Off            1: Once            2: Continuous            5: Preset 3200K            6: Preset 5000K            7: Preset 6500K            8: Preset 7500K</p>
			<p><b>Related Topic:</b>  <a href="#">White Balance</a></p>
AWBAreaSelector	-	0: Low Right	<p>Select the area for which to configure AWBAreaEnable.</p> <p><b>Note:</b> Color models only.</p> <p>0: Low Right            1: Low Mid-Right            2: Low Mid-Left            3: Low Left            4: Mid-Low Right            5: Mid-Low Mid-Right            6: Mid-Low Mid-Left            7: Mid-Low Left            8: Mid-High Right            9: Mid-High Mid-Right            10: Mid-High Mid-Left            11: Mid-High Left            12: High Right            13: High Mid-Right            14: High Mid-Left            15: High Left</p>
AWBAreaEnable	0: False 1: True	1: True	Enable/disable the photometry area selected in AWBAreaSelector.
AWBAreaEnableAll	0: False 1: True	1: True	<p>True: Operate BalanceWhiteAuto with all areas designated as photometry areas, regardless of the individual enabled/disabled photometry area states configured in AWBAreaSelector.</p> <p>False: Operate BalanceWhiteAuto according to the individual enabled/disabled photometry area states configured in AWBAreaSelector.</p>
AWBControlSpeed	1 ~ 8	4	Set the response speed for BalanceWhiteAuto. (8 is the fastest)

Analog Control Item	Setting Range	Default Value	Description
BalanceWhiteAuto Result	-	0: Idle	<p>Display the results of BalanceWhiteAuto.</p> <p><b>Note:</b> Color models only.</p> <p>0: Idle                      1: Processing                      2: Converging                      3: Succeeded                      4: Error1 - G image was too bright                      5: Error2 - G image was too dark                      6: Error3 - Timeout                      7: Error4 - could not processing                      8: Error5 - R or B image was out of range</p>
Gamma	0.45 ~ 1	0.45	<p>Set the gamma value.</p> <p>Setting Range: 0.45, 0.50, 0.55, 0.60, 0.65, 0.75, 0.80, 0.90, 1.00</p>
LUTMode	0: Off 1: Gamma 2: LUT	0:Off	Select the LUT mode.

## LUTControl

Configure LUT settings.

**Related Topic:** [LUT \(Lookup Table\)](#)

LUT Control Item	Setting Range	Default Value	Description
LUTSelector	0: Red 1: Green 2: Blue	0: Red	<p>Select the LUT channel to control.</p> <p><b>Note:</b> Color models only.</p>
LUTIndex	0 ~ 256	0	Set the LUT index table number.
LUTValue	0 ~ 4095	Gamma≡ 1.0	Set the LUT value.

# AutoLevelControl

Configure AutoLevelControl.

**Related Topic:** [ALC \(Automatic Level Control\) Function](#)

Auto Level Control Item	Setting Range	Default Value	Description
ALCControlReference	-	1: Selected Channel	<p>Sets the channel to be used for ALC control reference.</p> <p><b>Note:</b> Color models only.</p> <p>0: Peak Channel 1: Selected Channel</p>
ALCControlChannel	0: Red 1: Green 2: Blue	1: Green	<p>When ALCControlReference is set to SelectedChannel, this setting determines which RGB channel signal is used for ALC control.</p> <p>When ALCControlReferenc is set to PeakChannel, this setting is disabled.</p> <p><b>Note:</b> Color models only.</p>
ALCReference	5 ~ 95	50	Set the target level for ALC. (unit: %)
ALCAreaSelector	-	0: Low Right	<p>Select the area for which to configure ALCAreaEnable.</p> <p>0: Low Right 1: Low Mid-Right 2: Low Mid-Left 3: Low Left 4: Mid-Low Right 5: Mid-Low Mid-Right 6: Mid-Low Mid-Left 7: Mid-Low Left 8: Mid-High Right 9: Mid-High Mid-Right 10: Mid-High Mid-Left 11: Mid-High Left 12: High Right 13: High Mid-Right 14: High Mid-Left 15: High Left</p>
ALCAreaEnable	0: False 1: True	1: True	Enable/disable the photometry area selected in ALCAreaSelector.

Auto Level Control Item	Setting Range	Default Value	Description
ALCAreaEnableAll	0: False 1: True	1: True	True: Operate ALC with all areas designated as photometry areas, regardless of the individual enabled/disabled photometry area states configured in ALCAreaSelector. False: Operate ALC according to the individual enabled/disabled photometry area states configured in ALCAreaSelector.
ALCControlRatio	1 ~ 100	90	Set the response speed (%). (100 is the fastest.)
AutoControlStatus	-	0: Idle	Allows confirmation of the AGC, ASC, and AWB convergence status. 0: Idle 1: Processing - Exposure Time 2: Processing - Gain 3: Converging - Exposure Time 4: Converging - Gain 5: Error1 - could not processing 6: Error2 - timeout
ExposureAutoControlMin	-	100	Set the minimum value for the ExposureTime control range. (us) <b>Min:</b> 100 <b>Max:</b> ExposureTimeMax*-1
ExposureAutoControlMax	-	ExposureTimeMax*	Set the maximum value for the ExposureTime control range. (us) <b>Min:</b> ExposureAutoControlMin+1 <b>Max:</b> ExposureTimeMax*
GainAutoControlMin	-	1	Set the minimum value for the GainAuto control range. (Step ≒ 0.1dB) <b>Min:</b> 1 <b>Max:</b> (GainAutoControlMax - 1)
GainAutoControlMax	-	126	Set the maximum value for the GainAuto control range. (Step ≒ 0.1dB) <b>Min:</b> GainAutoControlMin+1 <b>Max:</b> 126

**Note:** \*ExposureTimeMax: The maximum exposure time value under the current setting conditions.

## ColorTransformationControl

Configure color transformation settings.

**Related Topic:** [Color Space Conversion \(ColorTransformationControl\)](#)

**Note:** This function is available only when the [Pixel Format](#) is set to **RGB8**, **RGB10V1Packed**, or **RGB10p32**.

Color Transformation Control Item	Setting Range	Default Value	Description
ColorTransformationMode	0:RGB 2:XYZ	0:RGB	Set the output image format.
ColorTransformationRGBMode	0: OFF 1: sRGB 2: AdobeRGB 3: UserCustom	0: OFF	Set the detailed mode when RGB is selected for the color space.
ColorMatrixValueSelector	0: R-R 1: R-G 2: R-B 3: G-R 4: G-G 5: G-B 6: B-R 7: B-G 8: B-B	0: R-R	Select the ColorMatrix setting component.
ColorMatrixValue	-2 ~ 2	-	Set the Color Matrix value. (Step = 0.1) <b>Default:</b> ColorMatrixValueSelector=0,4,8: 1.0 ColorMatrixValueSelector=1,2,3,5,6,7: 0

## ImagingControl

Configure other JAI functions.

Imaging Control Item	Setting Range	Default Value	Description
VideoProcessBypassMode  <b>Related Topic:</b> <a href="#">VideoProcessBypassMode</a>	0: Off 1: On	0: Off	Enable/disable VideoProcessBypass mode.
EdgeEnhancerEnable  <b>Related Topic:</b> <a href="#">Edge Enhancer</a> , <a href="#">Color Enhancer</a>	0: Off 1: On	0: Off	Enable/disable EdgeEnhancer.  <b>Note:</b> Monochrome models only.
EdgeEnhancerLevel	0: Low 1: Middle 2: High 3: Strong	1: Middle	Set the Level for EdgeEnhancer.  <b>Note:</b> Monochrome models only.
ColorEnhancerEnable  <b>Related Topic:</b> <a href="#">Edge Enhancer</a> , <a href="#">Color Enhancer</a>	0: Off 1: On	0: Off	Enable/disable ColorEnhancer.  <b>Note:</b> This function is available only when the <a href="#">Pixel Format</a> is set to <b>RGB8</b> , <b>RGB10V1Packed</b> , or <b>RGB10p32</b> .
ColorEnhancerSelector	0: Red 1: Cyan 2: Green 3: Magenta 4: Blue 5: Yellow	0:Red	Index for configuring detailed settings of ColorEnhancer.
ColorEnhancerValue	0 ~ 1.0	0	Set the enhancement to one of ten levels for each color element. (Step = 0.1)  0: No enhancement



## ShadingControl

Configure shading correction settings.

**Related Topic:** [Shading Correction](#)

Shading Control Item	Setting Range	Default Value	Description
ShadingCorrectionMode	-	0: Flat Shading	Select the shading correction method. 0: Flat Shading 1: Color Shading (Color models only)
ShadingMode	0: Off 1: User1 2: User2 3: User3	0: Off	Set the area to which to save shading correction data. When this is set to Off, PerformShadingCalibration will not be executed.
PerformShadingCalibration	-	-	Execute shading correction.  This command can not be executed under the following conditions. <ul style="list-style-type: none"> <li>- When outputting no image.</li> <li>- When outputting TestPattern.</li> <li>- Width and/or Height are less than 512 (<a href="#">ROI Function (Single ROI)</a>)</li> <li>- In FD2x2Binning mode (<a href="#">Binning Function</a>)</li> <li>- In ImageScaling mode (<a href="#">Image Scaling Mode (Xscale)</a>)</li> <li>- In Decimation mode (<a href="#">Decimation Mode</a>)</li> <li>- In Sequencer mode (<a href="#">Sequencer Function</a>)</li> <li>- In MultiRoi mode (<a href="#">ROI Function (Multi ROI)</a>)</li> <li>- In Reverse mode (<a href="#">Image Flip Function</a>)</li> <li>- In GradationCompression mode (<a href="#">Gradation Compression Mode</a>)</li> <li>- In ALC mode (<a href="#">ALC (Automatic Level Control) Function</a>)</li> <li>- AcquisitionMode is set to other than Continuous (<a href="#">AcquisitionControl</a>)</li> </ul>
ShadingDetectResult	-	0: Idle	Display the shading correction results.  0: Idle 1: Succeeded 2: Error1 - image was too bright 3: Error2 - image was too dark 4: Error3 - could not calibrated 5: Error4 - correction limit 6: Error5 - timeout

## BlemishControl

Configure settings for JAI white blemish correction.

**Related Topic:** [BlemishCompensation](#)

Blemish Control Item	Setting Range	Default Value	Description
BlemishEnable	-	1: Enable	Enable/disable blemish correction. 0: Disable all 1: Enable 2 :Disable user detection
BlemishDetect	-	-	Execute blemish detection. This command cannot be executed under the following conditions. - No image is being output. - TestPattern is being output - In Sequencer Mode ( <a href="#">Sequencer Function</a> ) - In MultiRoi mode ( <a href="#">ROI Function (Multi ROI)</a> ) - The image is not full ROI size ( <a href="#">ROI Function (Single ROI)</a> ) - In Reverse mode ( <a href="#">Image Flip Function</a> ) - GradationCompressionMode is not Off ( <a href="#">Gradation Compression Mode</a> ) - AcquisitionMode is not Continuous ( <a href="#">Acquisition Control</a> ) - Not in lens cap state
BlemishDetectionResult	-	0	Display the blemish detection results. 0: Idle 1: Succeeded 2: Error1 - image was too bright 3: Error2 - image was too dark (unused) 4: Error3 - signal level was unbalanced (unused) 5: Error4 - detect blemishes too many 6: Error5 - could not detected 7: Error6 - timeout
BlemishDetectThreshold	1 ~ 99	10	Set the blemish detection threshold.
BlemishStore	-	-	Save the location information of detected blemishes, manually specified by BlemishiCompensationPositionX and BlemishCompensationPositionY.
BlemishCompensationIndex	1 ~ 2000	1	Select the index for the target blemish coordinates.

Blemish Control Item	Setting Range	Default Value	Description
BlemishCompensationPositionX	-	-1	Display the X coordinate (horizontal pixel position) of the target blemish selected in BlemishCompensationIndex. You can also manually enter the X coordinate of the blemish you want to correct. <b>Min:</b> -1 <b>Max:</b> WidthMax - 1
BlemishCompensationPositionY	-	-1	Display the Y coordinate (vertical pixel position) of the target blemish selected in BlemishCompensationIndex. You can also manually enter the Y coordinate of the blemish you want to correct. <b>Min:</b> -1 <b>Max:</b> HeightMax - 1
BlemishCompensationDataClear	-	-	Delete detected or specified blemish information selected in BlemishCompensationIndex.
BlemishCompensationNumber	0 ~ 2000	0	Display the number of target blemishes.

## SequencerControl

Configure sequencer settings.

**Related Topic:** [Sequencer Function](#)

**Note:** Refer to [Functions That Cannot Be Used Together](#) for usage restrictions.

Sequencer Control Item	Setting Range	Default Value	Description
SequencerMode	0: Off 1: On	0: Off	Enable/disable SequencerMode.
SequencerModeSelect	-	0	Select the sequencer mode. 0: TriggerSequencerMode (Default) 1: CommandSequencerMode
SequencerSetSelector	1 ~ 32	1	Select the index number to configure.
SequencerWidth	-	WidthMax value	Set the width of the selected SequencerIndex. Setting Range: 96 (48)* ~ [WidthMax - OffsetX] , Step 8(4)* *For monochrome models, when BinningHorizontal = 2 or FD2x2BinningMode = On, the value in parentheses is applicable.

## User Manual (Ver. 1.3) - Setting List (Feature Properties)

GOX-5105MC-5GE | GOX-8105MC-5GE | GOX-12405MC-5GE | GOX-16205MC-5GE | GOX-20405MC-5GE | GOX-24505MC-5GE

Sequencer Control Item	Setting Range	Default Value	Description
SequencerHeight	-	HeightMax value	Set the height of the selected SequencerIndex. Setting Range: 8 (4)* ~ [HeightMax - OffsetY], Step 2(1)* *For monochrome models, when BinningVertical = 2 or FD2x2BinningMode = On, the value in parentheses is applicable.
SequencerOffsetX	-	0	Set the horizontal offset value for the selected SequencerIndex. Setting Range: 0 ~ [WidthtMax - Width], Step 8(4)* *For monochrome models, when BinningHorizontal = 2 or FD2x2BinningMode = On, the value in parentheses is applicable.
SequencerOffsetY	-	0	Set the vertical offset value for the selected SequencerIndex. Setting Range: 0 ~ [HeightMax - Height], Step 2(1)* *For monochrome models, when BinningVertical = 2 or FD2x2BinningMode = On, the value in parentheses is applicable.
SequencerFrameCount	1 ~ 65535	1	Set the FrameCount value for the selected SequencerIndex. <b>Note:</b> The same value with AcquisitionFrameCount ( <a href="#">AcquisitionControl</a> )
SequencerExposureTime	1 ~ 8000000	-	Set the exposure time for the selected SequencerIndex. <b>Default:</b> ExposureTimeMax* ( <a href="#">AcquisitionControl</a> )
SequencerGainAnalogAll	1.0 ~ 126.0	1	Set the Gain[AnalogAll] value for the selected SequencerIndex. <b>Note:</b> The same value with Gain[AnalogAll] ( <a href="#">AnalogControl</a> )
SequencerGainDigitalRed	0.447 ~ 5.624	1	Set the Gain[DigitalRed] value for the selected SequencerIndex. <b>Note:</b> The same value with Gain[DigitalRed] ( <a href="#">AnalogControl</a> ). Color models only.
SequencerGainDigitalBlue	0.447 ~ 5.624	1	Set the Gain[DigitalBlue] value for the selected SequencerIndex. <b>Note:</b> The same value with Gain[DigitalBlue] ( <a href="#">AnalogControl</a> ). Color models only.
SequencerLUTEnable	0: False 1: True	0: False	Set the LutEnable value for the selected SequencerIndex.

Sequencer Control Item	Setting Range	Default Value	Description
SequencerSetNext	0 ~ 32	-	Set the next index to be displayed for the selected SequencerIndex. (Enabled only for TriggerSequencer.) If 0 is specified, the operation of the Sequencer is stopped. SequencerSetSelector = 1 ~ 31: (SequencerSetSelector+1) SequencerSetSelector = 32: 1
SequencerRepetition	1 ~ 255	1	Set the repeat count for the sequencer.
SequencerSetActive	1 ~ 32	1	Displays the active index number.
SequencerSetStart	1 ~ 32	1	Specify the first index number to switch to when starting TriggerSequencerMode.
SequencerCommandIndex	1 ~ 32	1	Set this to change the SequencerIndex. (Enabled only for CommandSequencer.)
SequencerReset	-	-	In TriggerSequencerMode, reset the current index number to the number configured in SequencerSetStart.

**Note:** \*ExposureTimeMax: The maximum exposure time value under the current setting conditions.

## CounterAndTimerControl

Configure counter settings.

**Note:** This camera only supports the counter functions.

**Related Topic:** [Counter and Timer Control Function](#)

Counter and Timer Control Item	Setting Range	Default Value	Description
CounterSelector	0: Counter0 1: Counter1 2: Counter2 3: Counter3	0: Counter0	Select the counter.
CounterEventSource	-	0: Off	Assign the Counter Event signal for which you want to read the count value to a dedicated counter, and read the value.  0: Off 1: FrameTrigger (Counter0 only) 2: Exposure Start (Counter1 only) 3: Sensor Readout (Counter2 only) 4: FrameTransferEnd (Counter3 only)
CounterEventActivation	1:Rising Edge 2:Falling Edge	-	Set the count timing. The setting value is fixed with the following data.  <b>Default:</b> CounterSelector=0, 1, 2: Rising Edge CounterSelector=3: Falling Edge
CounterReset	-	-	Reset the counter.
CounterValue	0 ~ 32bit max	0	Display the count value.
CounterStatus	-	0: CounterIdle	Display the counter status.  0: CounterIdle 1: CounterTriggerWait 2: CounterActive 3: CounterCompleted 4: CounterOverflow - Count value exceeded the maximum value

## ActionControl

Configures action control settings.

**Related Topic:** [Action Control Function](#)

Action Control Item	Setting Range	Default Value	Description
ActionDeviceKey	0x00000000 ~ 0xFFFFFFFF	0x00000000	An action command is executed if this ActionDeviceKey matches the DeviceKey contained in the action command message.
ActionQueueSize			Displays the queue size of ScheduledActionCommand. This value represents the maximum number of ScheduledActionCommands that can be pending at the time a ScheduledActionCommand is given in time.
ActionSelector	0:Off 1:On	0:Off	Select the ActionSelector.
ActionGroupMask	0x00000000 ~ 0xFFFFFFFF	0x00000000	An action command is executed if the result of an AND operation of GroupMask contained in this ActionGroupMask and an action command message is not 0.
ActionGroupKey	0x00000000 ~ 0xFFFFFFFF	0x00000000	An action command is executed if this ActionGroupKey matches the GroupKey contained in the action command message.

## EventControl

Configure settings for event control.

**Related Topic:** [Event Control Function](#)

**Note:** On this camera, Frame ID is fixed to "0" because it is not fixed when the event occurs.

Event Control Item	Setting Range	Default Value	Description
EventSelector	-	0: Acquisition Trigger	Select the event to send the event message.  0: AcquisitionTrigger 1: FrameStart 2: FrameEnd 5: ExposureStart 6: ExposureEnd
EventNotification	0: Off 1: On	0: Off	Sets whether or not to send an event message when an event selected by EventSelector occurs.
EventAcquisitionTriggerData	-	-	When the event AcquisitionTrigger occurs, the following three data can be checked.
EventAcquisitionTrigger	-	0x9002	Displays the EventID (0x9002).
EventAcquisitionTriggerTimestamp	0 ~ 64bit max	0	Displays the Timestamp value when an event occurs.
EventAcquisitionTriggerFrameID	-	0 (Fixed)	Displays the FrameID value when an event occurs.
EventFrameStartData	-	-	When the event FrameStartData occurs, the following three data can be checked.
EventFrameStart	-	0x9300	Displays the EventID (0x9300).
EventFrameStartTimestamp	0 ~ 64bit max	0	Displays the Timestamp value when an event occurs.
EventFrameStartFrameID	-	0 (Fixed)	Displays the FrameID value when an event occurs.
EventFrameEndData	-	-	When the event FrameEndData occurs, the following three data can be checked.
EventFrameEnd	-	0x9301	Displays the EventID (0x9301).
EventFrameEndTimestamp	0 ~ 64bit max	0	Displays the Timestamp value when an event occurs.
EventFrameEndFrameID	-	0 (Fixed)	Displays the FrameID value when an event occurs.



Event Control Item	Setting Range	Default Value	Description
EventExposureStartData	-	-	When the event ExposureStartData occurs, the following three data can be checked.
EventExposureStart	-	0x9003	Displays the EventID (0x9003).
EventExposureStartTimestamp	0 ~ 64bit max	0	Displays the Timestamp value when an event occurs.
EventExposureStartFrameID	-	0 (Fixed)	Displays the FrameID value when an event occurs.
EventExposureEndData	-	-	When the event ExposureEndData occurs, the following three data can be checked.
EventExposureEnd	-	0x9004	Displays the EventID (0x9004).
EventExposureEndTimestamp	0 ~ 64bit max	0	Displays the Timestamp value when an event occurs.
EventExposureEndFrameID	-	0 (Fixed)	Displays the FrameID value when an event occurs.

## ChunkDataControl

Configure Chunk Control settings.

**Related Topic:** [Chunk Data Function](#)

Chunk Data Control Item	Setting Range	Default Value	Description
ChunkModeActive	0: Off 1: On	0: Off	Set whether to enable ChunkData.
ChunkOffsetX	-	-	Display the OffsetX value ( <a href="#">ImageFormatControl</a> ) ChunkID: 0x00002000
ChunkOffsetY	-	-	Display the OffsetY value ( <a href="#">ImageFormatControl</a> ) ChunkID: 0x00002001
ChunkWidth	-	-	Display the Width value ( <a href="#">ImageFormatControl</a> ) ChunkID: 0x00002002
ChunkHeight	-	-	Display the Height value ( <a href="#">ImageFormatControl</a> ) ChunkID: 0x00002003
ChunkLineStyleAll	-	-	Display the LineStatusAll value ( <a href="#">DigitalIOControl</a> ) ChunkID: 0x00002013

## User Manual (Ver. 1.3) - Setting List (Feature Properties)

GOX-5105MC-5GE | GOX-8105MC-5GE | GOX-12405MC-5GE | GOX-16205MC-5GE | GOX-20405MC-5GE | GOX-24505MC-5GE

Chunk Data Control Item	Setting Range	Default Value	Description
ChunkExposureTime	-	-	<p>Display the ExposureTime value (us). ChunkID: 0x00002004</p> <p><b>Note:</b> The value displayed in ChunkExposureTime includes the exposure offset value (2us).</p> <p>ChunkExposureTime: <i>ExposureTime</i> (<a href="#">AcquisitionControl</a>) value + 2us</p>
ChunkGainSelector	0: Analog All 1: Digital Red 2: Digital Blue	0: Analog All	Select the Gain to configure.
ChunkGain	-	-	<p>Display the Gain value (<a href="#">AnalogControl</a>)</p> <p>0: Analog All - ChunkID: 0x0000201F 1: Digital Red - ChunkID: 0x00002006 3: Digital Blue - ChunkID: 0x00002007</p>
ChunkFrameTriggerCounter	-	-	<p>Display the value for CounterValue[Counter0] (<a href="#">CounterAndTimerControl</a>). Data acquisition timing is FrameStart. ChunkID: 0x0000200E</p>
ChunkSequencerSetActive	-	-	<p>Displays the SequencerSet number currently set in TriggerSequenceMode or CommandSequencerMode. (1 is displayed in Normal Mode.) (<a href="#">SequencerControl</a>) ChunkID: 0x0000200C</p>

## TestControl

Configure the test control setting.

Test Control Item	Setting Range	Default Value	Description
TestPendingAck	0 ~ 10000	0	PendingAck function test command. The camera waits for TestPendingAck (ms) time and returns an Ack response.

## UserSetControl

Configure user settings.

**Related Topic:** [Step 7: Save the Settings](#)

User Set Control Item	Setting Range	Default Value	Description
UserSetSelector	-	0: Default	Select the user settings. 0: Default - Invalid when executing UserSetSave 1: User1 2: User2 3: User3
UserSetLoad	-	-	Read the user settings specified in UserSetSelector. When selecting <b>Default</b> for UserSetSelector, the factory settings are loaded.
UserSetSave	-	-	Overwrite the current setting values with the user settings specified in UserSetSelector. Invalid when UserSetSelector is set to Default.

# Miscellaneous

## Troubleshooting

---

Check the following before requesting help. If the problem persists, contact your local JAI distributor.

### Power Supply and Connections

**Issue:** The POWER/TRIG LED remains lit amber and does not turn green, even after power is supplied to the camera.

**Cause and Solution:**

- Camera initialization may not be complete due to a lack of power. Check the 6-pin power cable connection.

Or the GigE connection may be not established. Check the ethernet cable connection.

### Image Display

**Issue:** Gradation in dark areas is not noticeable.

**Cause and Solution:** Use the gamma function to correct the display. As the light-emitting properties of the monitor are not linear, the entire image may be darker or the gradation in the dark areas may be less noticeable when camera outputs are displayed without processing. Using the gamma function performs correction to produce a display that is close to linear. For details, see [Gamma Function](#).

### Settings and Operations

**Issue:** Settings cannot be saved to user memory.

**Cause and Solution:** You cannot save to user memory while images are being acquired by the camera. Stop image acquisition before performing the save operation.

**Issue:** I want to restore the factory default settings.

**Cause and Solution:** Load Default under User Set Selector in the Feature Properties tab to restore the factory default settings.

## Specifications

Item	Monochrome	Color	
Scanning System	Progressive scan, 1 tap		
Synchronization	Internal		
Interface	5GBASE-T Ethernet (GigE Vision 2.0), IEEE 802.3af		
Image Sensor	Monochrome CMOS	Bayer Color CMOS	
Dark SN	>60 dB@10bit		
	<b>Conditions:</b>		
	GOX-5105MC-5GE	AnalogGainAll:x1.0,Shutter:OFF, SensorDigitizationBits=12bit, Mono10/Bayer10, Frame Rate: 97.6 fps	
	GOX-8105MC-5GE	AnalogGainAll:x1.0,Shutter:OFF, SensorDigitizationBits=12bit, Mono10/Bayer10, Frame Rate: 62.2 fps	
	GOX-12405MC-5GE	AnalogGainAll:x1.0,Shutter:OFF, SensorDigitizationBits=12bit, Mono10/Bayer10, Frame Rate:41.1 fps	
	GOX-16205MC-5GE	AnalogGainAll:x1.0,Shutter:OFF, SensorDigitizationBits=12bit, Mono10/Bayer10, Frame Rate: 31.8 fps	
	GOX-20405MC-5GE	AnalogGainAll:x1.0,Shutter:OFF, SensorDigitizationBits=12bit, Mono10/Bayer10, Frame Rate:25.6 fps	
	GOX-24505MC-5GE	AnalogGainAll:x1.0,Shutter:OFF, SensorDigitizationBits=12bit, Mono10/Bayer10, Frame Rate: 21.2 fps	
Bright SN	>38 dB	>36 dB(Gch)	
Image Size (Effective Image)	GOX-5105MC-5GE	Type 1/1.8	6.8 mm x 5.7 mm (8.82mm diagonal)
	GOX-8105MC-5GE	Type 2/3	7.8 mm x 7.8 mm (11.05mm diagonal)
	GOX-12405MC-5GE	Type 1/1.1	11.3 mm x 8.2 mm (14.00mm diagonal)
	GOX-16205MC-5GE	Type 1.1	14.6 mm x 8.3 mm (16.81mm diagonal)
	GOX-20405MC-5GE	Type 1.1	12.4 mm x 12.4 mm (17.48mm diagonal)
	GOX-24505MC-5GE	Type 1.2	14.6 mm x 12.6 mm (19.30mm diagonal)
Pixel Size	2.74 μm x 2.74 μm		

Item	Monochrome	Color																						
Effective Image Pixel	GOX-5105MC-5GE: 2472 x 2064 GOX-8105MC-5GE: 2856 x 2848 GOX-12405MC-5GE: 4128 x 3008 GOX-16205MC-5GE: 5328 x 3040 GOX-20405MC-5GE: 4512 x 4512 GOX-24505MC-5GE: 5328 x 4608																							
Acquisition Frame Rate (Max)  Mono8, BayerRG8, BayerGR8, BayerGB8, BayerBG8	<table border="1"> <thead> <tr> <th></th> <th>PacketSize 1476</th> <th>PacketSize 12036</th> </tr> </thead> <tbody> <tr> <td>GOX-5105MC-5GE</td> <td>98 fps</td> <td>103 fps</td> </tr> <tr> <td>GOX-8105MC-5GE</td> <td>62 fps</td> <td>66 fps</td> </tr> <tr> <td>GOX-12405MC-5GE</td> <td>41 fps</td> <td>43 fps</td> </tr> <tr> <td>GOX-16205MC-5GE</td> <td>32 fps</td> <td>33 fps</td> </tr> <tr> <td>GOX-20405MC-5GE</td> <td>25 fps</td> <td>27 fps</td> </tr> <tr> <td>GOX-24505MC-5GE</td> <td>21 fps</td> <td>22 fps</td> </tr> </tbody> </table>				PacketSize 1476	PacketSize 12036	GOX-5105MC-5GE	98 fps	103 fps	GOX-8105MC-5GE	62 fps	66 fps	GOX-12405MC-5GE	41 fps	43 fps	GOX-16205MC-5GE	32 fps	33 fps	GOX-20405MC-5GE	25 fps	27 fps	GOX-24505MC-5GE	21 fps	22 fps
		PacketSize 1476	PacketSize 12036																					
	GOX-5105MC-5GE	98 fps	103 fps																					
	GOX-8105MC-5GE	62 fps	66 fps																					
	GOX-12405MC-5GE	41 fps	43 fps																					
	GOX-16205MC-5GE	32 fps	33 fps																					
	GOX-20405MC-5GE	25 fps	27 fps																					
	GOX-24505MC-5GE	21 fps	22 fps																					
<p><b>Notes:</b></p> <ul style="list-style-type: none"> <li>• See <a href="#">Notes on Supplying Power via PoE</a> for the frame rate restriction when using the PoE power supply.</li> <li>• The above frame rates are when SensorDigitizationBits is set to 10Bits, NetworkThroughputSafetyMargin is set to 92, and ExtendedIDMode = Off.</li> </ul>																								
Acquisition Frame Rate (Max)  Mono10Packed, Mono12Packed, BayerRG10Packed, BayerRG12Packed, BayerGR10Packed, BayerGR12Packed, BayerGB10Packed, BayerGB12Packed, BayerBG10Packed, BayerBG12Packed	<table border="1"> <thead> <tr> <th></th> <th>PacketSize 1476</th> <th>PacketSize 12036</th> </tr> </thead> <tbody> <tr> <td>GOX-5105MC-5GE</td> <td>65 fps</td> <td>69 fps</td> </tr> <tr> <td>GOX-8105MC-5GE</td> <td>41 fps</td> <td>44 fps</td> </tr> <tr> <td>GOX-12405MC-5GE</td> <td>27 fps</td> <td>29 fps</td> </tr> <tr> <td>GOX-16205MC-5GE</td> <td>21 fps</td> <td>22 fps</td> </tr> <tr> <td>GOX-20405MC-5GE</td> <td>17 fps</td> <td>18 fps</td> </tr> <tr> <td>GOX-24505MC-5GE</td> <td>14 fps</td> <td>15 fps</td> </tr> </tbody> </table>				PacketSize 1476	PacketSize 12036	GOX-5105MC-5GE	65 fps	69 fps	GOX-8105MC-5GE	41 fps	44 fps	GOX-12405MC-5GE	27 fps	29 fps	GOX-16205MC-5GE	21 fps	22 fps	GOX-20405MC-5GE	17 fps	18 fps	GOX-24505MC-5GE	14 fps	15 fps
		PacketSize 1476	PacketSize 12036																					
	GOX-5105MC-5GE	65 fps	69 fps																					
	GOX-8105MC-5GE	41 fps	44 fps																					
	GOX-12405MC-5GE	27 fps	29 fps																					
	GOX-16205MC-5GE	21 fps	22 fps																					
	GOX-20405MC-5GE	17 fps	18 fps																					
GOX-24505MC-5GE	14 fps	15 fps																						
<p><b>Notes:</b></p> <ul style="list-style-type: none"> <li>• See <a href="#">Notes on Supplying Power via PoE</a> for the frame rate restriction when using the PoE power supply.</li> <li>• The above frame rates are when SensorDigitizationBits is set to 10Bits, NetworkThroughputSafetyMargin is set to 92, and ExtendedIDMode = Off.</li> <li>• If SensorDigitizationBits is set to smaller than the pixel format bits configured in the <a href="#">Pixel Format</a>, the image may have gaps in the histogram.</li> </ul>																								

Item	Monochrome		Color	
Acquisition Frame Rate (Max)  Mono10, Mono12, BayerRG10, BayerRG12, BayerGR10, BayerGR12, BayerGB10, BayerGB12, BayerBG10, BayerBG12			<b>PacketSize 1476</b>	<b>PacketSize 12036</b>
	GOX-5105MC-5GE	49 fps	51 fps	
	GOX-8105MC-5GE	31 fps	33 fps	
	GOX-12405MC-5GE	20 fps	21 fps	
	GOX-16205MC-5GE	16 fps	16 fps	
	GOX-20405MC-5GE	12 fps	13 fps	
	GOX-24505MC-5GE	10 fps	11 fps	
	<p><b>Notes:</b></p> <ul style="list-style-type: none"> <li>• See <a href="#">Notes on Supplying Power via PoE</a> for the frame rate restriction when using the PoE power supply.</li> <li>• The above frame rates are when SensorDigitizationBits is set to 10Bits, NetworkThroughputSafetyMargin is set to 92, and ExtendedIDMode = Off.</li> <li>• If SensorDigitizationBits is set to smaller than the pixel format bits configured in the <a href="#">Pixel Format</a>, the image may have gaps in the histogram.</li> </ul>			
Acquisition Frame Rate (Max)  RGB8			<b>PacketSize 1476</b>	<b>PacketSize 12036</b>
	GOX-5105C-5GE	32 fps	34 fps	
	GOX-8105C-5GE	20 fps	22 fps	
	GOX-12405C-5GE	13 fps	14 fps	
	GOX-16205C-5GE	10 fps	11 fps	
	GOX-20405C-5GE	8 fps	9 fps	
	GOX-24505C-5GE	7 fps	7 fps	
	<p><b>Notes:</b></p> <ul style="list-style-type: none"> <li>• See <a href="#">Notes on Supplying Power via PoE</a> for the frame rate restriction when using the PoE power supply.</li> <li>• The above frame rates are when SensorDigitizationBits is set to 10Bits, NetworkThroughputSafetyMargin is set to 92, and ExtendedIDMode = Off.</li> </ul>			

Item	Monochrome	Color	
Acquisition Frame Rate (Max) RGB10V1Packed, RGB10p32		PacketSize 1476	PacketSize 12036
	GOX-5105C-5GE	24 fps	26 fps
	GOX-8105C-5GE	15 fps	16 fps
	GOX-12405C-5GE	10 fps	10 fps
	GOX-16205C-5GE	8 fps	8 fps
	GOX-20405C-5GE	6 fps	6 fps
	GOX-24505C-5GE	5 fps	5 fps
	<p><b>Notes:</b></p> <ul style="list-style-type: none"> <li>• See <a href="#">Notes on Supplying Power via PoE</a> for the frame rate restriction when using the PoE power supply.</li> <li>• The above frame rates are when SensorDigitizationBits is set to 10Bits, NetworkThroughputSafetyMargin is set to 92, and ExtendedIDMode = Off.</li> <li>• If SensorDigitizationBits is set to smaller than the pixel format bits configured in the <a href="#">Pixel Format</a>, the image may have gaps in the histogram.</li> </ul>		
Digital Image Output Format - Full	GOX-5105MC-5GE: 2472 x 2064 GOX-8105MC-5GE: 2856 x 2848 GOX-12405MC-5GE: 4128 x 3008 GOX-16205MC-5GE: 5328 x 3040 GOX-20405MC-5GE: 4512 x 4512 GOX-24505MC-5GE: 5328 x 4608		
Digital Image Output Format - ROI (Width)	GOX-5105MC-5GE: 96(48) to 2472 (1236), step 8(4) GOX-8105MC-5GE: 96(48) to 2856(1428), step 8(4) GOX-12405MC-5GE: 96(48) to 4128 (2064), step 8(4) GOX-16205MC-5GE: 96(48) to 5328 (2664), step 8(4) GOX-20405MC-5GE: 96(48) to 4512 (2256), step 8(4) GOX-24505MC-5GE: 96(48) to 5328 (2664), step 8(4)		
<p><b>Note:</b> For monochrome models, when BinningHorizontal = 2 or FD2x2BinningMode = On, the value in parenthesis is applicable.</p>			



Item	Monochrome	Color
Digital Image Output Format - ROI (Offset X)	<p>GOX-5105MC-5GE: 0 to [2472 (1236) - Width], step 8(4)                      GOX-8105MC-5GE: 0 to [2856(1428) - Width], step 8(4)                      GOX-12405MC-5GE: 0 to [4128 (2064) - Width], step 8(4)                      GOX-16205MC-5GE: 0 to [5328 (2664) - Width], step 8(4)                      GOX-20405MC-5GE: 0 to [4512 (2256) - Width], step 8(4)                      GOX-24505MC-5GE: 0 to [5328 (2664) - Width], step 8(4)</p> <p><b>Note:</b> For monochrome models, when BinningHorizontal = 2 or FD2x2BinningMode = On, the value in parenthesis is applicable.</p>	
Digital Image Output Format - ROI (Height)	<p>GOX-5105MC-5GE: 8(4) to 2064 (1032), step2(1)                      GOX-8105MC-5GE: 8(4) to 2848 (1424), step2(1)                      GOX-12405MC-5GE: 8(4) to 3008 (1504), step2(1)                      GOX-16205MC-5GE: 8(4) to 3040 (1520), step2(1)                      GOX-20405MC-5GE: 8(4) to 4512 (2256), step2(1)                      GOX-24505MC-5GE: 8(4) to 4608 (2304), step2(1)</p> <p><b>Note:</b> For monochrome models, when BinningVertical = 2 or FD2x2BinningMode = On, the value in parenthesis is applicable.</p>	
Digital Image Output Format - ROI (Offset Y)	<p>GOX-5105MC-5GE: 0 to [2064 (1032) - Height], step2(1)                      GOX-8105MC-5GE: 0 to [2848 (1424) - Height], step2(1)                      GOX-12405MC-5GE: 0 to [3008 (1504) - Height], step2(1)                      GOX-16205MC-5GE: 0 to [3040 (1520) - Height], step2(1)                      GOX-20405MC-5GE: 0 to [4512 (2256) - Height], step2(1)                      GOX-24505MC-5GE: 0 to [4608 (2304) - Height], step2(1)</p> <p><b>Note:</b> For monochrome models, when BinningHorizontal = 2 or FD2x2BinningMode = On, the value in parenthesis is applicable.</p>	
Digital Image Output Format: Binning (H) = 1 and FD2x2BinningMode = Off	<p>GOX-5105M-5GE: 2472                      GOX-8105M-5GE: 2856                      GOX-12405M-5GE: 4128                      GOX-16205M-5GE: 5328                      GOX-20405M-5GE: 4512                      GOX-24505M-5GE: 5328</p>	N/A
Digital Image Output Format: Binning (H) = 2 or FD2x2BinningMode = On	<p>GOX-5105M-5GE: 1236                      GOX-8105M-5GE: 1428                      GOX-12405M-5GE: 2064                      GOX-16205M-5GE: 2664                      GOX-20405M-5GE: 2256                      GOX-24505M-5GE: 2664</p>	N/A

Item	Monochrome	Color
Digital Image Output Format:  Binning (V) = 1 and FD2x2BinningMode = Off	GOX-5105M-5GE: 2064 GOX-8105M-5GE: 2848 GOX-12405M-5GE: 3008 GOX-16205M-5GE: 3040 GOX-20405M-5GE: 4512 GOX-24505M-5GE: 4608	N/A
Digital Image Output Format:  Binning (V) = 2 or FD2x2BinningMode = On	GOX-5105M-5GE: 1032 GOX-8105M-5GE: 1424 GOX-12405M-5GE: 1504 GOX-16205M-5GE: 1520 GOX-20405M-5GE: 2256 GOX-24505M-5GE: 2304	N/A
Digital Image Output Format: Pixel Format	Mono8 (default), Mono10, Mono10Packed, Mono12, Mono12Packed	BayerRG8 (default), BayerRG10, BayerRG10Packed, BayerRG12, BayerRG12Packed, BayerGR8*, BayerGR10*, BayerGR10Packed*, BayerGR12*, BayerGR12Packed*, BayerGB8*, BayerGB10*, BayerGB10Packed*, BayerGB12*, BayerGB12Packed*, BayerBG8*, BayerBG10*, BayerBG10Packed*, BayerBG12*, BayerBG12Packed*, RGB8**, RGB10V1Packed**, RGB10p32**  <div style="border: 1px solid black; padding: 5px; background-color: #f0f0f0;"> <b>Note:</b> * When ReverseX/ReverseY is On.                     </div>
Acquisition Mode	Continuous / SingleFrame / MultiFrame (1 ~ 65535)	
Trigger Selector	<b>Acquisition:</b> AcquisitionStart / AcquisitionEnd <b>Exposure:</b> FrameStart <b>Transfer:</b> AcquisitionTransferStart( Delayed readout)	
Opto Filter	0 ~ 40ms, Step 100ns	
Trigger Overlap	Off / Read out	
Trigger Input Signals	PulseGenerator0-3, UserOutput0-3, Action0-3, Software, Line5 Opt In, Nand0 Out, Nand1 Out	
Exposure Mode	Timed (FrameStartTrigger Off): 3.45* $\mu$ s ~ ExposureTimeMax (The maximum exposure time value under the current setting conditions.) Timed (FrameStartTrigger On): 3.45* $\mu$ s ~ 8Sec TriggerWidth: 3.45* $\mu$ s ~ $\infty$  <div style="border: 1px solid black; padding: 5px; background-color: #f0f0f0;"> <b>Note:</b> *Including the exposure offset duration (2.45 <math>\mu</math>s).                     </div>	
Auto Exposure (Exposure Auto)	Off / Continuous / Once	

Item	Monochrome	Color
Auto Exposure Response Speed (ALCControlRatio)	1 ~ 100%	
Digital I/O	LineSelector (6P): GPIO IN / GPIO OUT	
Black Level Adjustment	Default Level: 8LSB@8bit All (Mono/Color): -133 ~ +255 LSB Red (Color): -64 ~ +64 LSB Blue (Color): -64 ~ +64 LSB Resolution Adjustment: 1LSB@12bit	
Gain Adjustment	Manual Adjustment Range: AnalogAll (Mono/Color): 0db ~ 42dB DigitalRed (Color): -7dB ~ 15dB DigitalBlue (Color): -7dB ~ 15dB Adjustment Auto Gain: Off, Continuous, Once	
White Balance	WhiteBalanceGain: DigitalRed, DigitalBlue :0.447 ~ 5.624, 1STEP = x 0.0001 BalanceWhiteAuto: Off, Continuous, Once, Preset3200K, Preset5000K, Preset6500K, Preset7500K Photometry Area: 16 (4 x 4) Area Adjustment Range: 3000K ~ 9000K	
Blemish Correction	<p><b>Detection:</b> Detect white blemishes using threshold values (100 steps available) (black blemish correction performed only at the factory)</p> <p><b>Correction:</b> Interpolation using adjacent pixels. Continuous blemishes can be corrected up to 3 horizontal pixels (up to 3 horizontal pixels of the same Bayer color, for color models).</p> <p><b>Correctable pixels:</b> 2000 pixels</p>	
ALC	Video level adjusted automatically using AGC and ASC	
Gamma	0.45, 0.5, 0.55, 0.6, 0.65, 0.75, 0.8, 0.9, 1.0 (9 steps available)	
LUT	OFF : $\gamma = 1.0$ , ON = 257 points can be set	
Vibration Resistance	10G (20 Hz ~ 200 Hz X-Y-Z direction)	
Impact Resistance	80G	
Power Supply	PoE	Input Range: DC +36 ~ +57V Consumption: 6.7W typical (Default setting/ 25 °C Environment) @DC +48 V, 198mA / 9.5W (Max)
	6-pin Connector	Input Range: DC +10V ~ +25V Consumption: 5.1 W typical (Default setting/ 25 °C Environment) @ DC +12 V, 666mA/8.0W (Max)
Lens Mount	<ul style="list-style-type: none"> <li>C-Mount</li> <li>Lens mount protrusion length of 9 mm or less is supported.</li> </ul>	

Item	Monochrome	Color
Flange Back	17.526mm, tolerance: 0 mm ~ -0.05 mm	
Optical Filter	IR cut filter (color model only)	
Verified Performance Temperature/Humidity	-5°C ~ +45°C / 20% ~ 80% (non-condensing) <b>Note:</b> It may change depending on the installation environment. Please refer to the Cautions.	
Storage Temperature/Humidity	-25°C ~ +60°C / 20% ~ 80% (non-condensing)	
Regulations (Tentative)	CE [EN 55032:2015(CISPR32:2015) Class A, EN 55035:2017 (CISPR35:2016)], FCC Part 15 Class A, EU RoHS/WEEE, China RoHS, KC	
Housing	29mm x 29mm x 68mm(WHD, excluding connectors)	
Weight	95g	

**Notes:**

- Design and specifications are subject to change without notice.
- Approximately 30 minutes of warm-up are required to achieve these specifications.

**Cautions:**

The performance specifications given for this camera have been verified for the Operating Temperature range shown in the Specifications table. The camera may be able to perform outside of the specified temperature range, but such performance has not been verified and is therefore not guaranteed.

- The camera's internal temperature should not exceed the following maximum temperature. You can monitor the camera's internal temperature by DeviceTemperature ([DeviceControl](#)).

Measurement Area	Maximum Temperature Allowed
FPGA	95°C
Sensor	100°C
PHY	100°C

If the above temperature conditions are exceeded, take measures to dissipate heat according to your installation environment and conditions.

Note that the camera will become uncontrollable from the host side if any of the above temperatures are reached. For more information, see [Temperature Warning Mode](#).

# Spectral Response (GOX-5105M-5GE/GOX-5105C-5GE)

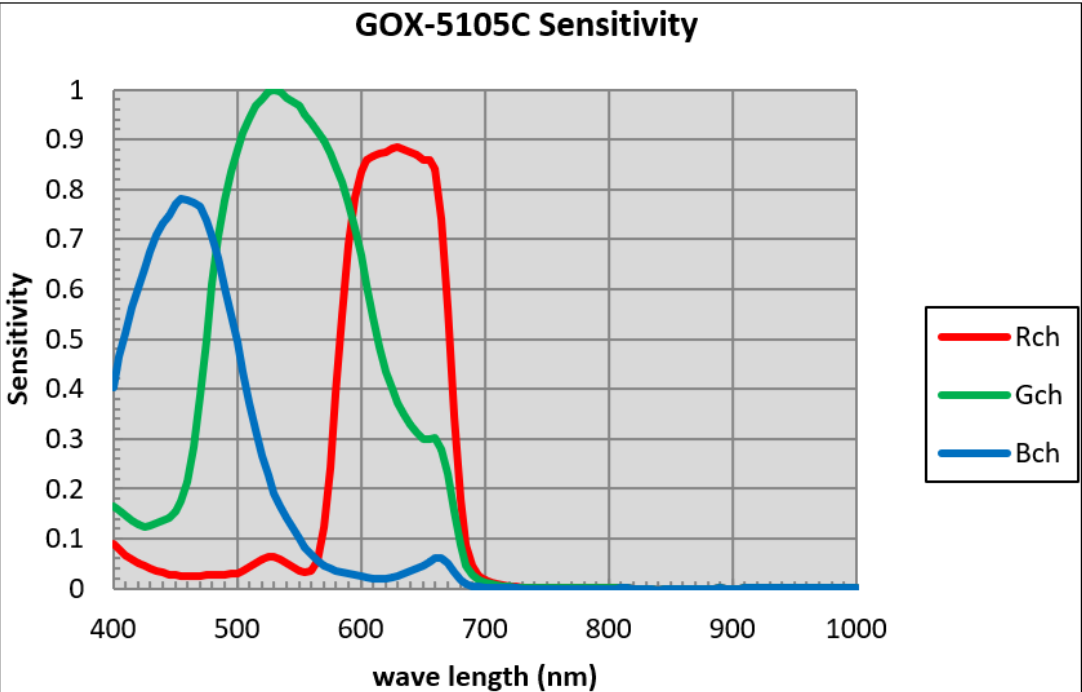
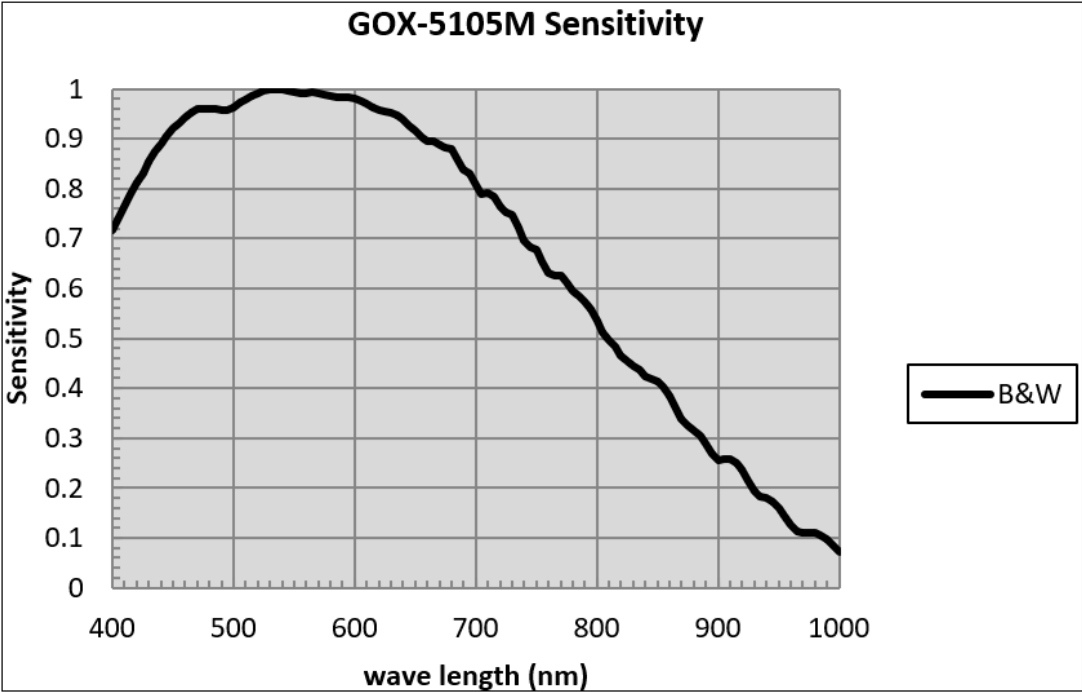

# Spectral Response (GOX-8105M-5GE/GOX-8105C-5GE)

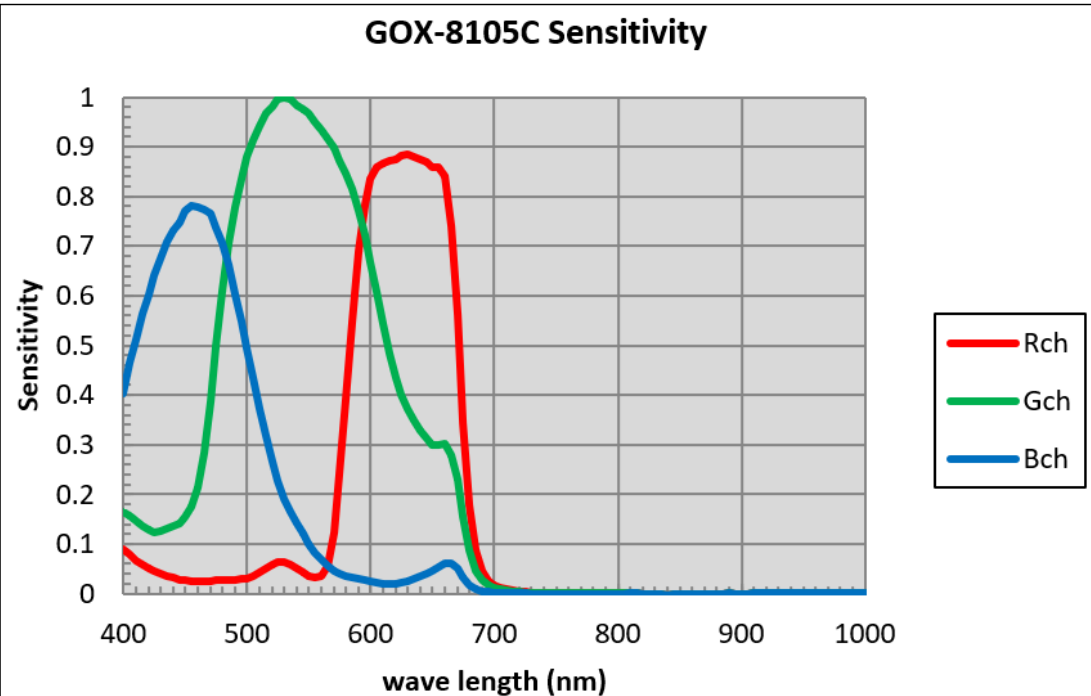
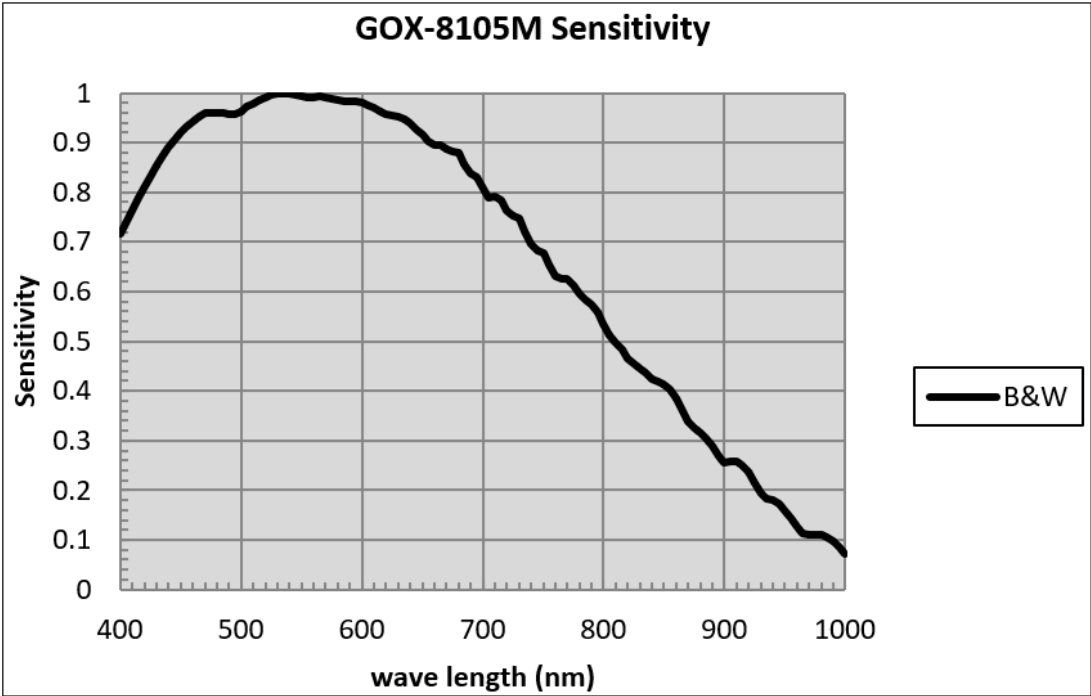

## Spectral Response (GOX-12405M-5GE/GOX-12405C-5GE)

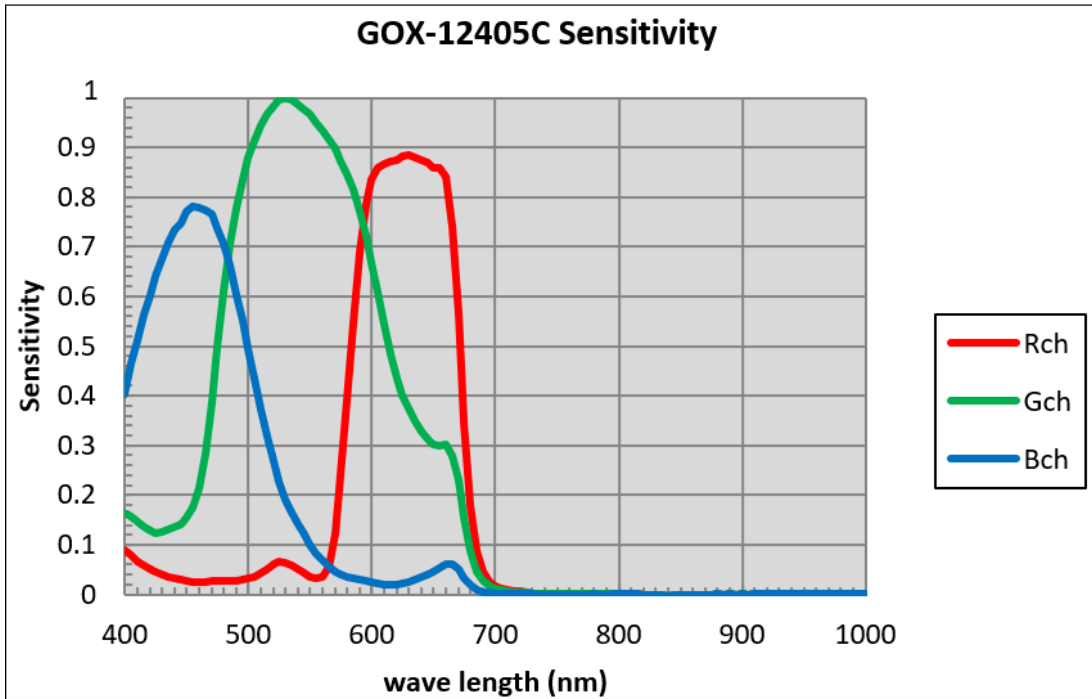
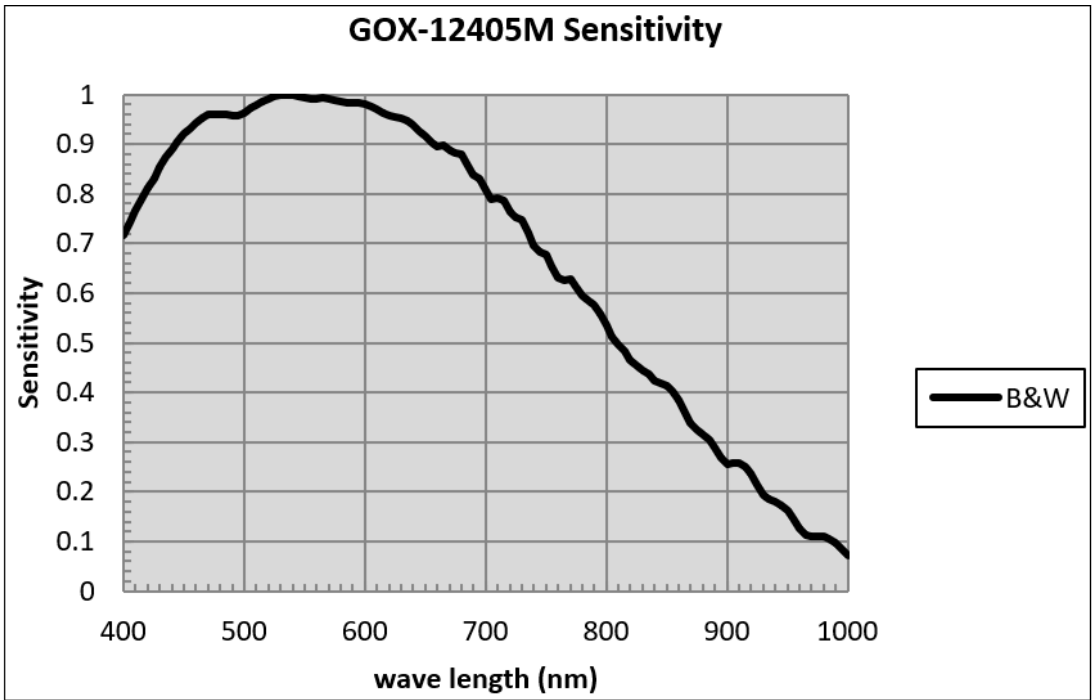

## Spectral Response (GOX-16205M-5GE/GOX-16205C-5GE)

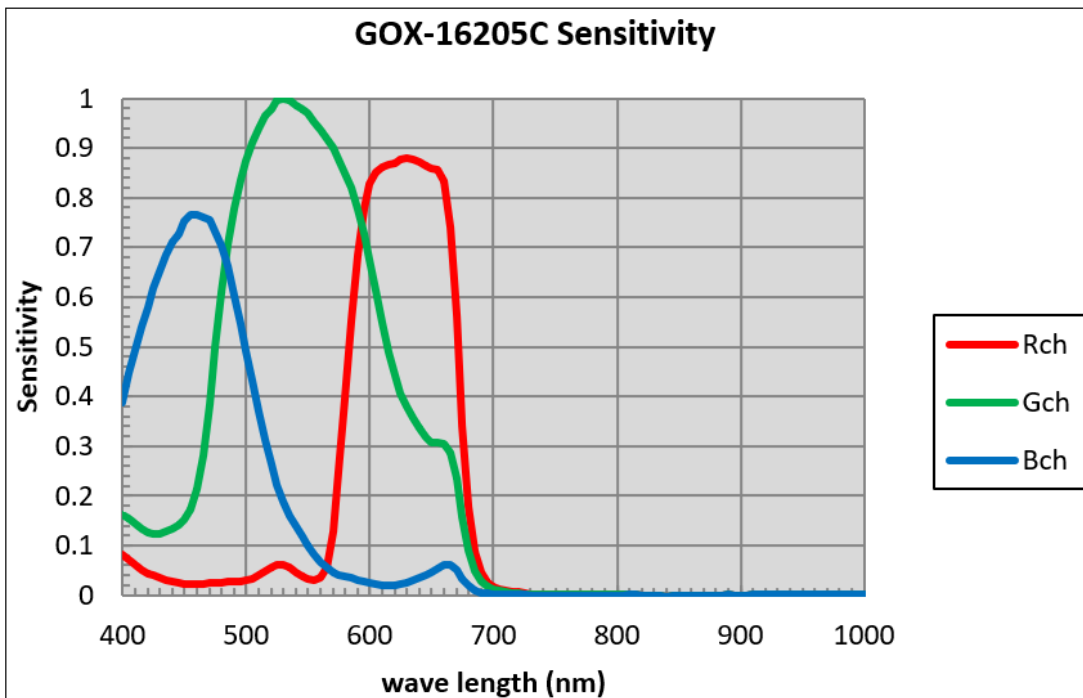
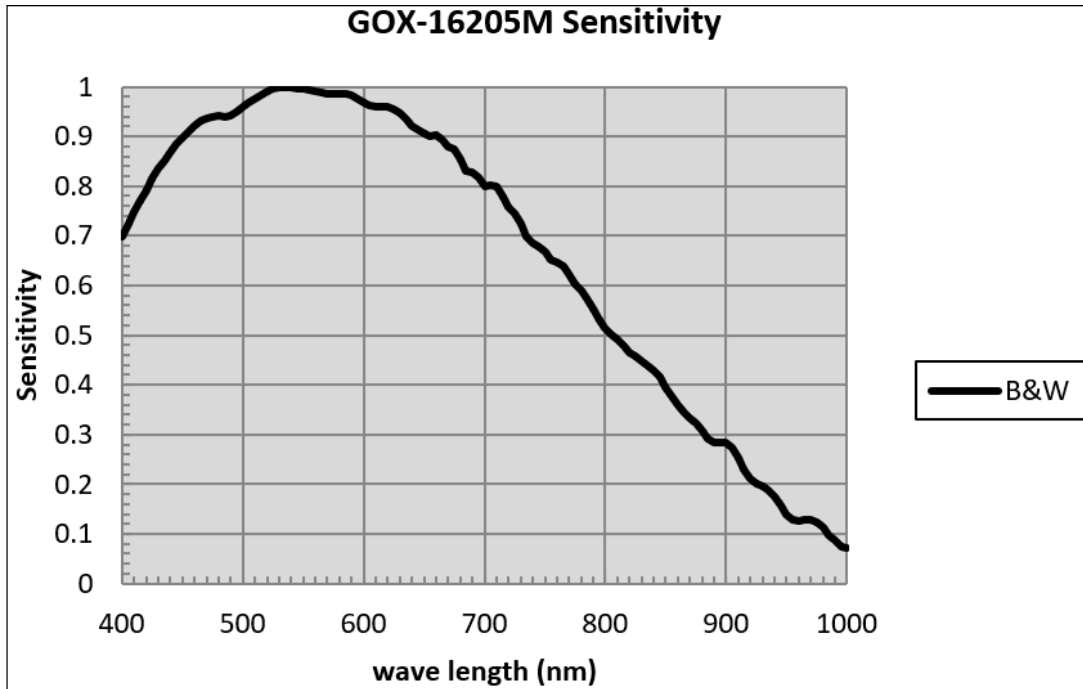



# Spectral Response (GOX-20405M-5GE/GOX-20405C-5GE)

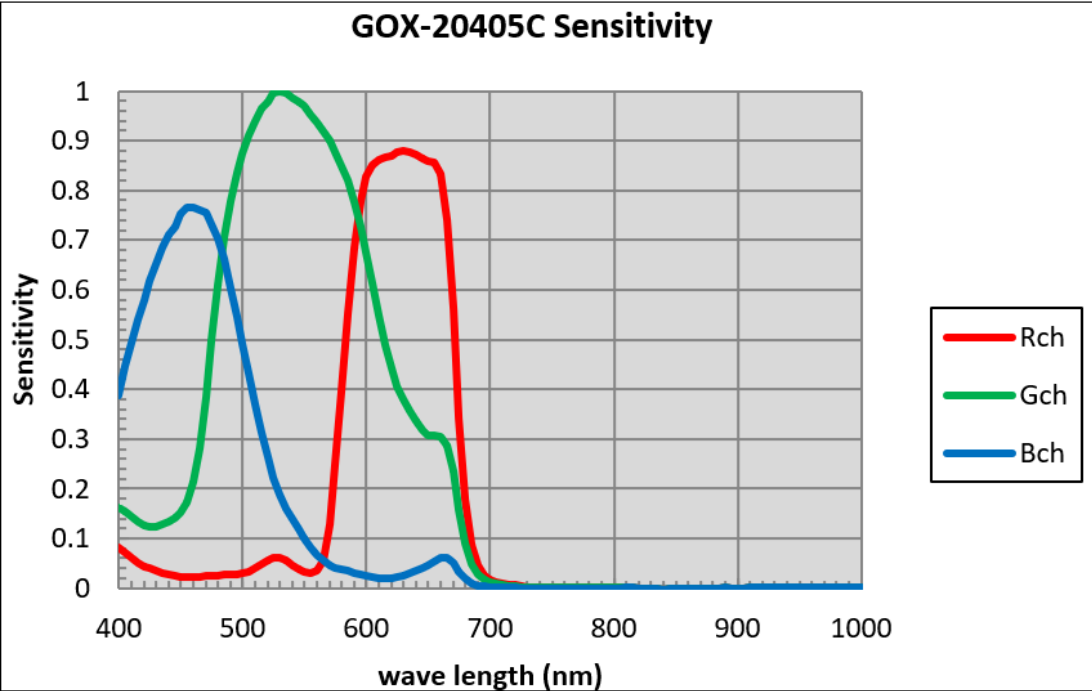
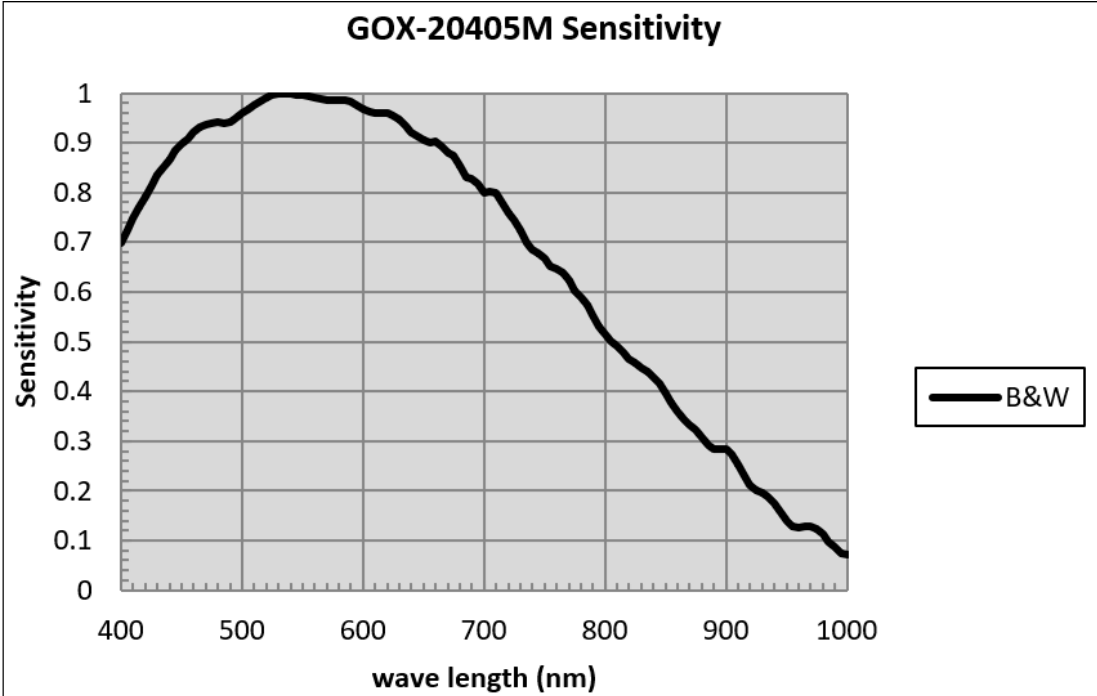

## Spectral Response (GOX-24505M-5GE/GOX-24505C-5GE)

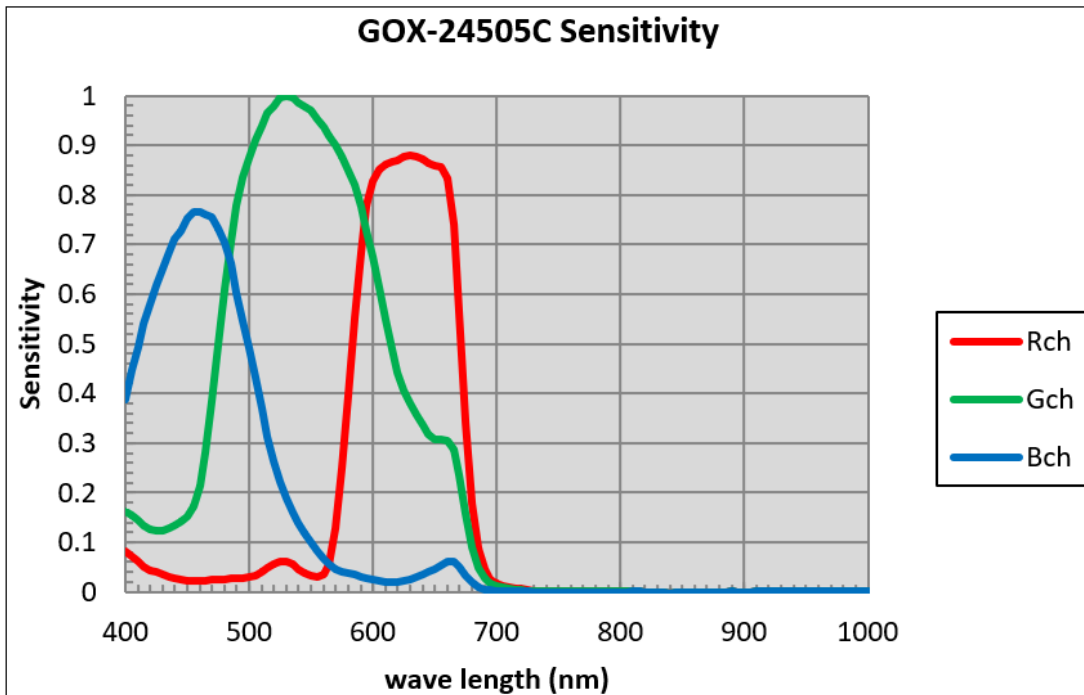
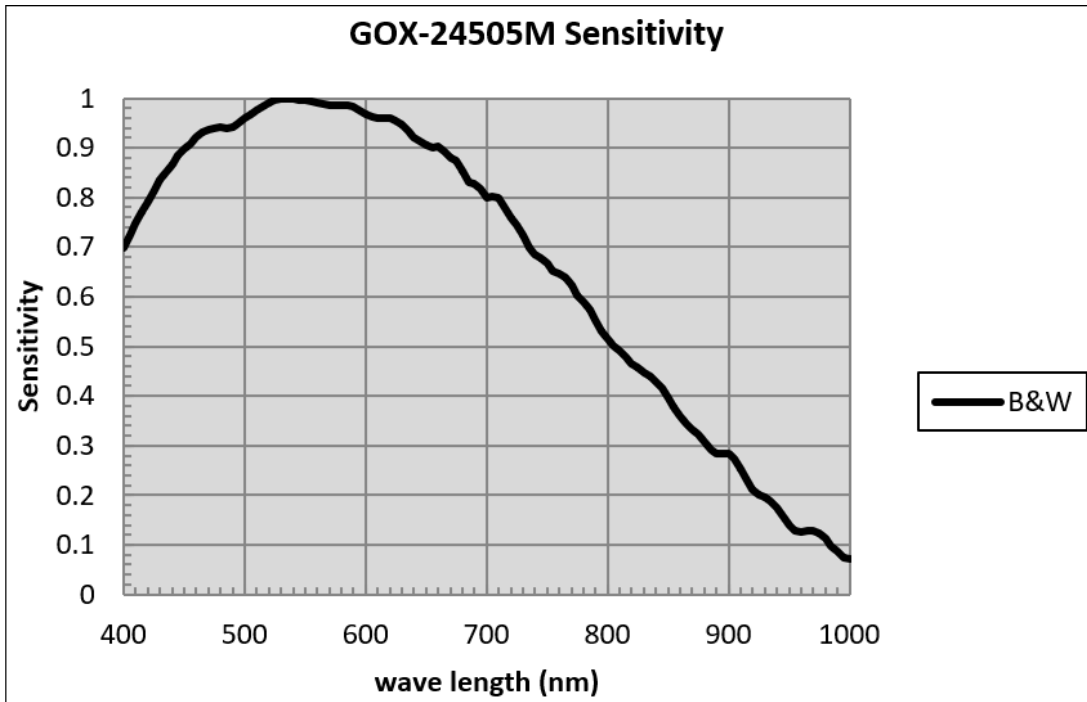

## Dimensions

This section shows the dimensions for this camera and the JAI HS-02 heatsink set).

### Camera

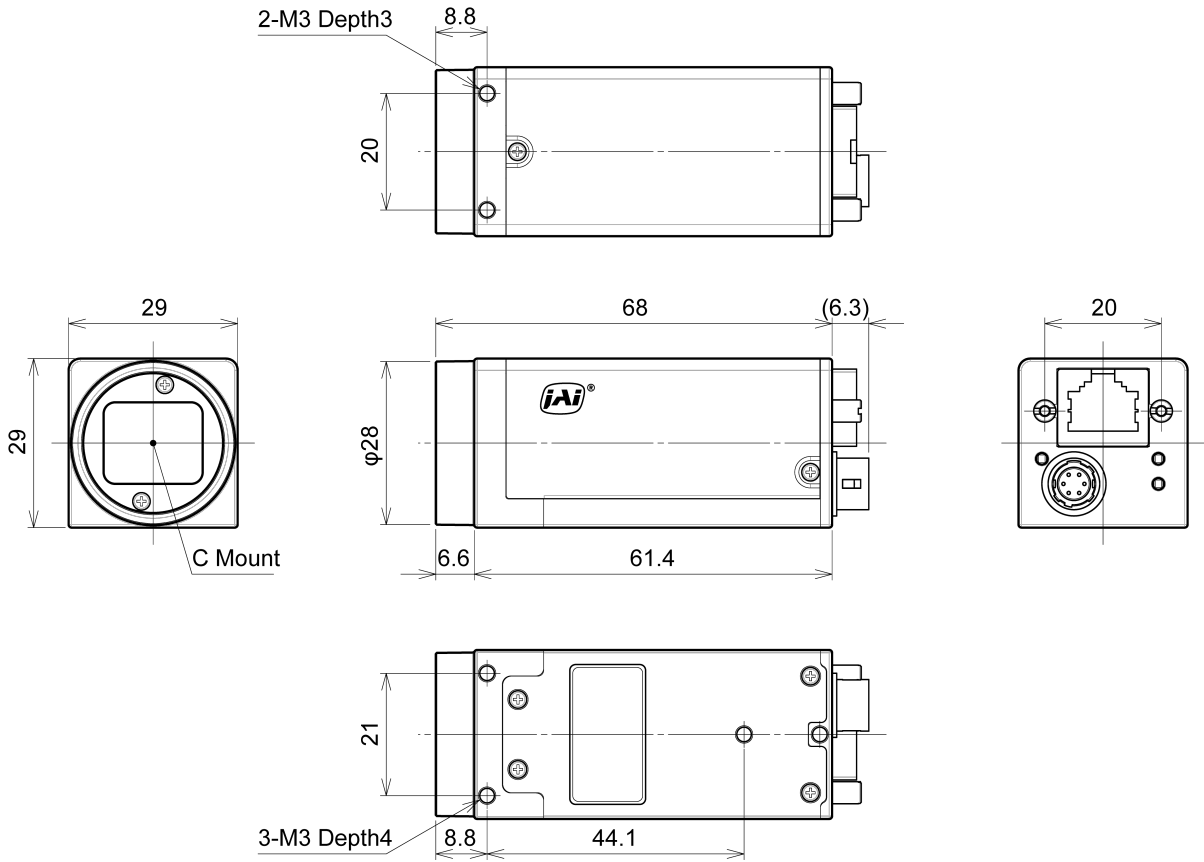

#### Notes:

- Dimensional tolerance:  $\pm 0.3\text{mm}$
- Unit: mm

# JAI HS-02 Heatsink Set

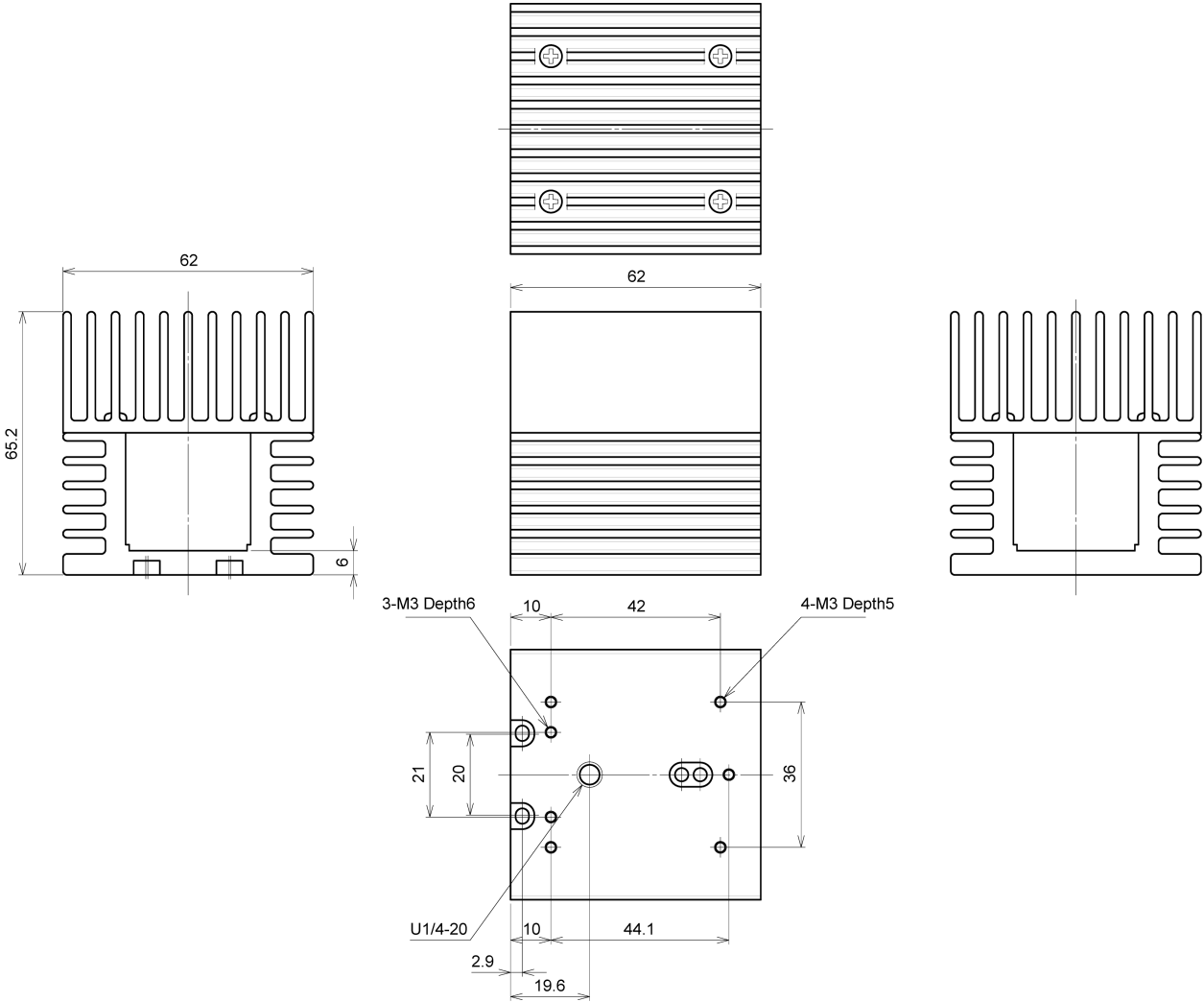

**Notes:**

- Dimensional tolerance:  $\pm 0.3\text{mm}$
- Unit: mm

### JAI HS-02 Heatsink Set with the Camera

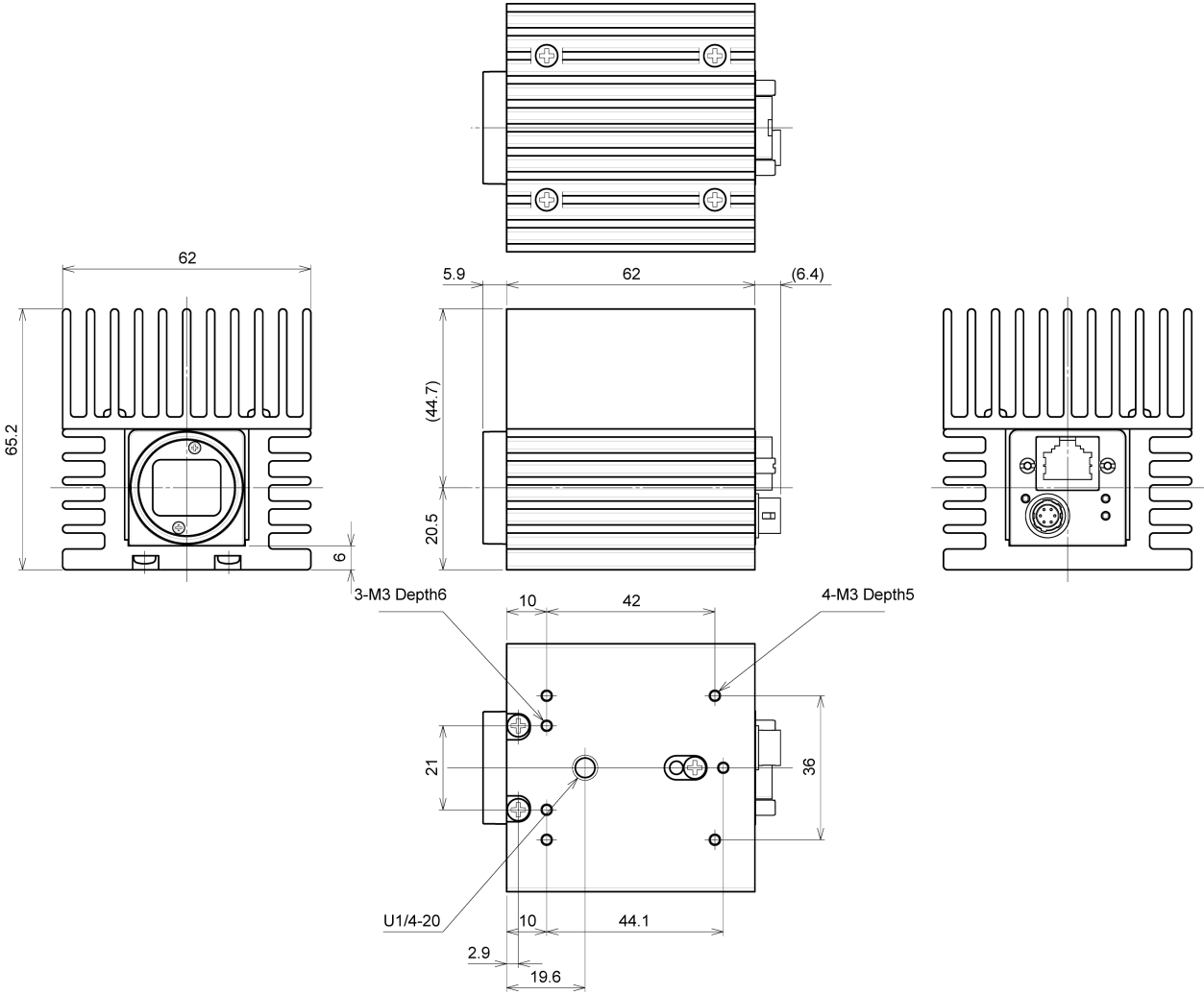

- Notes:**
- Dimensional tolerance:  $\pm 0.3\text{mm}$
  - Unit: mm

## Comparison of the Decibel Display and Multiplier Display

Decibels [dB]	Multipliers [X]	Remarks
-6	0.501	
-5	0.562	
-4	0.631	
-3	0.708	
-2	0.794	
-1	0.891	
0	1	
1	1.122	
2	1.259	
3	1.413	
4	1.585	
5	1.778	
6	1.995	
7	2.239	
8	2.512	
9	2.818	
10	3.162	
11	3.548	
12	3.981	
13	4.467	
14	5.012	
15	5.623	
16	6.31	
17	7.079	
18	7.943	
19	8.913	
20	10	
21	11.22	
22	12.589	
23	14.125	
24	15.849	
25	17.783	
26	19.953	
27	22.387	
28	25.119	
29	28.184	
30	31.623	
31	35.481	

GOX-5105MC-5GE | GOX-8105MC-5GE | GOX-12405MC-5GE | GOX-16205MC-5GE | GOX-20405MC-5GE | GOX-24505MC-5GE

Decibels [dB]	Multipliers [X]	Remarks
32	39.811	
33	44.668	
34	50.119	
35	56.234	
36	63.096	
37	70.795	
38	79.433	
39	89.125	
40	100	
41	112.202	
42	125.893	

## User's Record

---

Camera type: Go-X Series Global Shutter with 5GigE interface

Model name: .....

Revision: .....

Serial No: .....

Firmware version: .....

For camera revision history, please contact your local JAI distributor.

## Appendix

### Related Topic: [Notes on Supplying Power via PoE](#)

This section provides information on the camera's temperature (°C) when the camera is operating with a PoE power supply with the JAI HS-02 heatsink set) attached.

**Note:** You can monitor the camera's internal temperature by DeviceTemperature ([DeviceControl](#)).

	FPGA	Sensor	PHY	Camera Top Plate	Comment
Max Temperature Allowed	95°C	100°C	100°C	-	-
Temperature with the JAI HS-02 Heatsink Set	86°C	82°C	94°C	76°C	Time to Reach Steady State Temperature: 120 minutes
Conditions: LAN Cable: 100m, Ambient Temperature: 45°C, Model: GOX-24505C-5GE, Frame Rate: Full (Fastest)					

**Warning:** As shown here, even when operating with the JAI HS-02 Heatsink Set attached, the camera can reach temperatures that trigger [Temperature Warning Mode](#) to reduce the camera's frame rate. In these situations, you should take additional steps to cool the camera.



# Revision History

Revision	Date	Device Version	Changes
1.3	2024/05/17	DV0103	Added a note regarding the test environment ( <a href="#">Notes on Supplying Power via PoE</a> ).
1.2	2024/01/17	DV0103	Added ReverseXY ( <a href="#">Image Flip Function</a> ).
1.1	2023/08/18	DV0102	<p>New functions: <a href="#">Temperature Warning Mode</a> and <a href="#">ROI Centered</a>.</p> <p>Updated the <a href="#">Timing Chart</a> chapter.</p> <p>Added LineSource to the table in the <a href="#">GPIO (Digital Input/Output Settings)</a> topic.</p> <p>Added the description about ExposureTimeMax (<a href="#">AutoLevelControl</a>, etc).</p> <p><a href="#">Decimation Mode</a>: Added a note indicating that the parameters cannot be set individually.</p> <p>Added notes to <a href="#">Overlay Mode</a>.</p> <p>Updated <a href="#">China RoHS</a>.</p>
1.0	2023/03/07	DV0101	First Version

## Trademarks

Systems and product names described in this document are trademarks or registered trademarks of their respective owners. The ™ and ® symbols are not used in this document.

### Europe, Middle East & Africa

Phone +45 4457 8888  
Fax +45 4491 8880

### Asia Pacific

Phone +81 45 440 0154  
Fax +81 45 440 0166

### Americas

Phone (Toll-Free) 1 800 445 5444  
Phone +1 408 383 0300

Visit our website on [www.jai.com](http://www.jai.com)



See the possibilities