



See the possibilities

User Manual

FSFE-3200T-10GE (Flex-Eye)

Digital 3CMOS Progressive Scan Customized Camera

Document Version: 1.1

FSFE-3200T-10GE-Flex-Eye_Ver.1.1_Nov.2022

Thank you for purchasing this product.

 Be sure to read this manual before use.

This manual includes important safety precautions and instructions on how to operate the unit. Be sure to read this manual to ensure proper operation.

The contents of this manual are subject to change without notice for the purpose of improvement.

© 2020 - 2022 JAI

Contents

Notice/Warranty/Certifications	4	Gamma Function	55
Usage Precautions	6	Lookup Table (LUT)	56
Features	7	Blemish Compensation	57
Parts Identifications	8	Shading Correction	58
Preparation	14	Binning Function	59
Preparation Process	14	ROI (Regional Scanning Function)	60
Step 1:Installing the Software	14	Multi ROI	61
Step 2:Connecting Devices	15	Sequencer Function	62
Step 3:Verifying Camera Operation	17	Chunk Data Function	64
Step 4:Verifying the Connection between the Camera and PC	17	Pulse Generator	65
Step 5:Configuring Basic Settings for the Camera	20	Event Control Function	66
Step 6:Adjusting the Image Quality	21	Action Control Function	67
Step 7:Saving the Settings	23	Counter And Timer Control Function	68
Three stream transmission	24	PTP (Precision Time Protocol)	70
Display video in Sensor 1/Stream 1	25	Setting List	70
Simultaneous transmission/display of all three streams	27	Feature Properties	70
Main Functions	30	Miscellaneous	84
Three Image Sensors	30	Troubleshooting	84
Pixel format	35	Specifications	85
Video Process Bypass Mode	36	Maximum Frame Rate Reference	87
Bandwidth of two streams	36	Dimensions	89
Acquisition Control	37	Comparison of the Decibel Display and Multiplier Display	90
Exposure Mode	38	User's Record	91
Trigger Control	40	Index	92
GPIO (Digital Input/Output Settings)	42	Revision history	93
Use case (1)	45		
Use case (2)	46		
Basic Function Matrix	47		
Calculate the maximum frame rate (approximate)	48		
Gain Control	53		
ALC (Automatic Level Control) Function	54		

Notice

The material contained in this manual consists of information that is proprietary to JAI Ltd., Japan and may only be used by the purchasers of the product. JAI Ltd., Japan makes no warranty for the use of its product and assumes no responsibility for any errors which may appear or for damages resulting from the use of the information contained herein. JAI Ltd., Japan reserves the right to make changes without notice. Company and product names mentioned in this manual are trademarks or registered trademarks of their respective owners.

Warranty

For information about the warranty, please contact your factory representative.

Certifications

CE compliance

As defined by the Directive 2004/108/EC of the European Parliament and of the Council, EMC (Electromagnetic compatibility), JAI Ltd., Japan declares that FS-3200T-10GE-NNC complies with the following provisions applying to its standards.

EN 55032:2015(CISPR32:2015)

EN 55035:2017(CISPR35:2016)

FCC

This equipment has been tested and found to comply with the limits for a Class B digital device, pursuant to Part 15 of the FCC Rules. These limits are designed to provide reasonable protection against harmful interference in a residential installation. This equipment generates, uses and can radiate radio frequency energy and, if not installed and used in accordance with the instructions, may cause harmful interference to radio communications. However, there is no guarantee that interference will not occur in a particular installation. If this equipment does cause harmful interference to radio or television reception, which can be determined by turning the equipment off and on, the user is encouraged to try to correct the interference by one or more of the following measures:

- Reorient or relocate the receiving antenna.
- Increase the separation between the equipment and receiver.
- Connect the equipment into an outlet on a circuit different from that to which the receiver is connected.
- Consult the dealer or an experienced radio/TV technician for help.

Warning

Changes or modifications to this unit not expressly approved by the party responsible for FCC compliance could void the user's authority to operate the equipment.

Supplement

The following statement is related to the regulation on “Measures for the Administration of the control of Pollution by Electronic Information Products”, known as “China RoHS”. The table shows contained Hazardous Substances in this camera.

 mark shows that the environment-friendly use period of contained Hazardous Substances is 15 years.

重要注意事项

有毒，有害物质或元素名称及含量表

根据中华人民共和国信息产业部『电子信息产品污染控制管理办法』，本产品《有毒，有害物质或元素名称及含量表》如下。

部件名称	有毒有害物质或元素					
	铅 (Pb)	汞 (Hg)	镉 (Cd)	六价铬 (Cr (VI))	多溴联苯 (PPB)	多溴二苯醚 (PBDE)
棱镜	×	○	○	○	○	○
光学滤镜	×	○	×	○	○	○
连接插头	×	○	○	○	○	○
电路板	×	○	○	○	○	○
.....

○: 表示该有毒有害物质在该部件所有均质材料中的含量均在GB/T 26572-2011规定的限量要求以下。
 ×: 表示该有毒有害物质至少在该部件的某一均质材料中的含量超出GB/T 26572-2011规定的限量要求。
 (企业可在此处,根据实际情况对上表中打“×”的技术原因进行进一步说明。)



环保使用期限

电子信息产品中含有的有毒有害物质或元素在正常使用的条件下不会发生外泄或突变、电子信息产品用户使用该电子信息产品不会对环境造成严重污染或对基人身、财产造成严重损害的期限。

数字「15」为期限15年。

Usage Precautions

Notes on cable configurations

The presence of lighting equipment and television receivers nearby may result in video noise. In such cases, change the cable configurations or placement.

Notes on temperature conditions

The guaranteed operating temperature and humidity of this camera are -5°C to $+45^{\circ}\text{C}$, 20% to 80% (non-condensing). Please make sure the following temperature condition is met when operating the unit.

- 1) The camera's internal temperature sensor detects temperatures of 101°C or less during operation.

If the above temperature conditions are exceeded, take measures to dissipate heat according to your installation environment and conditions.

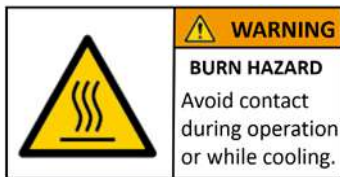

Depending on the operating environment, the surface of the camera may become very hot during operation. Do not touch the camera during operation and while it is being cooled. Also, make sure that the cable surface and other easily deformable items do not contact the surface of the camera.

Notes on attaching the lens

Avoiding dust particles

When attaching the lens to the camera, stray dust and other particles may adhere to the sensor surface and rear surface of the lens. Be careful of the following when attaching the lens.

- Work in a clean environment.
- Do not remove the caps from the camera and lens until immediately before you attach the lens.
- To prevent dust from adhering to surfaces, point the camera and lens downward and do not allow the lens surface to come into contact with your hands or other objects.
- Always use a blower brush to remove any dust that adheres. Never use your hands or cloth, blow with your mouth, or use other methods to remove dust.

Phenomena specific to CMOS image sensors

The following phenomena are known to occur on cameras equipped with CMOS image sensors. These do not indicate malfunctions.

- Aliasing
When shooting straight lines, stripes, and similar patterns, vertical aliasing (zigzag distortion) may appear on the monitor.
- Blooming
When strong light enters the camera, some pixels on the CMOS image sensor may receive much more light than they are designed to hold, causing the accumulated signal charge to overflow into surrounding pixels. This "blooming" phenomenon can be seen in the image, but does not affect the operation of the camera.
- Fixed pattern noise
When shooting dark objects in high-temperature conditions, fixed pattern noise may occur throughout the entire video monitor screen.
- Defective pixels
Defective pixels (white and black pixels) of the CMOS image sensor are minimized at the factory according to shipping standards. However, as this phenomenon can be affected by the ambient temperature, camera settings (e.g., high sensitivity and long exposure), and other factors, be sure to operate within the camera's specified operating environment.

Notes on exportation

When exporting this product, please follow the export regulations of your country or region.

Features

The FSFE-3200T-10GE (Flex-Eye) model is a customizable prism-based multispectral camera equipped with three 3.2-megapixel CMOS sensors. Each customer defines in advance the spectral range (wavelengths) that will be captured by each of the camera's three sensors.

The camera's three wavebands can all be located within the visible spectrum (405 nm to 680 nm) or the user can place the wavebands in locations throughout the visible and NIR spectrums from 405 nm to 1000 nm. Wavebands must be a minimum of 25 nm wide with a minimum step of 5 nm.

For any waveband located in the visible spectrum, the customer can specify whether to use a Bayer color sensor or a monochrome sensor.

The camera features a 10GBASE-T interface which enables it to support a 10 Gigabit Ethernet connection. The interface will auto-negotiate to lower speeds depending on the capability of the PC or network.

Feature overview

- Three global shutter high resolution CMOS image sensors.
- Effective pixels: 2048(h) x 1536(v).
- 1/1.8-inch optical format.
- Pixel size is 3.45 μ m x 3.45 μ m.
- It can output three video streams simultaneously.
- Two operation modes are available: asynchronous mode in which imaging conditions for three image streams can be set individually, and synchronous mode in which imaging conditions are synchronized.
- For Bayer color sensors, available pixel formats are BayerRG8, BayerRG10, BayerRG10Packed, BayerRG12, and BayerRG12Packed.
- For monochrome image sensors, available pixel formats are Mono8, Mono10, Mono10Packed, Mono12, and Mono12Packed.
- The camera supports the following Ethernet standards:
1000Base-T, 2.5GBase-T, 5GBase-T, 10GBase-T
- High-speed scanning (Maximum line rate)
Pixel Format BayerRG8 or Mono8: 107.2 fps
- Supports 1x2, 2x1, or 2x2 binning function.
(monochrome image sensors only)
- Supports FlatShading and ColorShading.
- Excellent shock and vibration resistance.
- GenICam compliant.

Connection example)

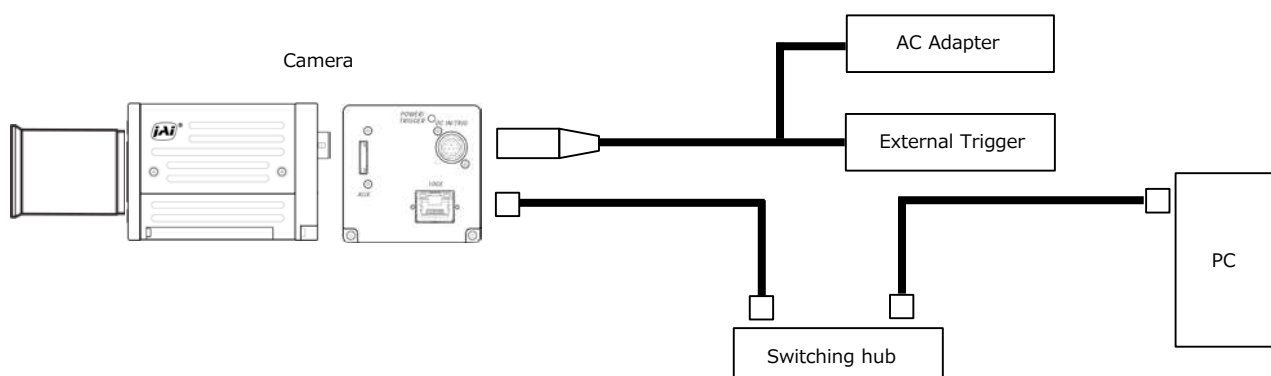

Parts Identification

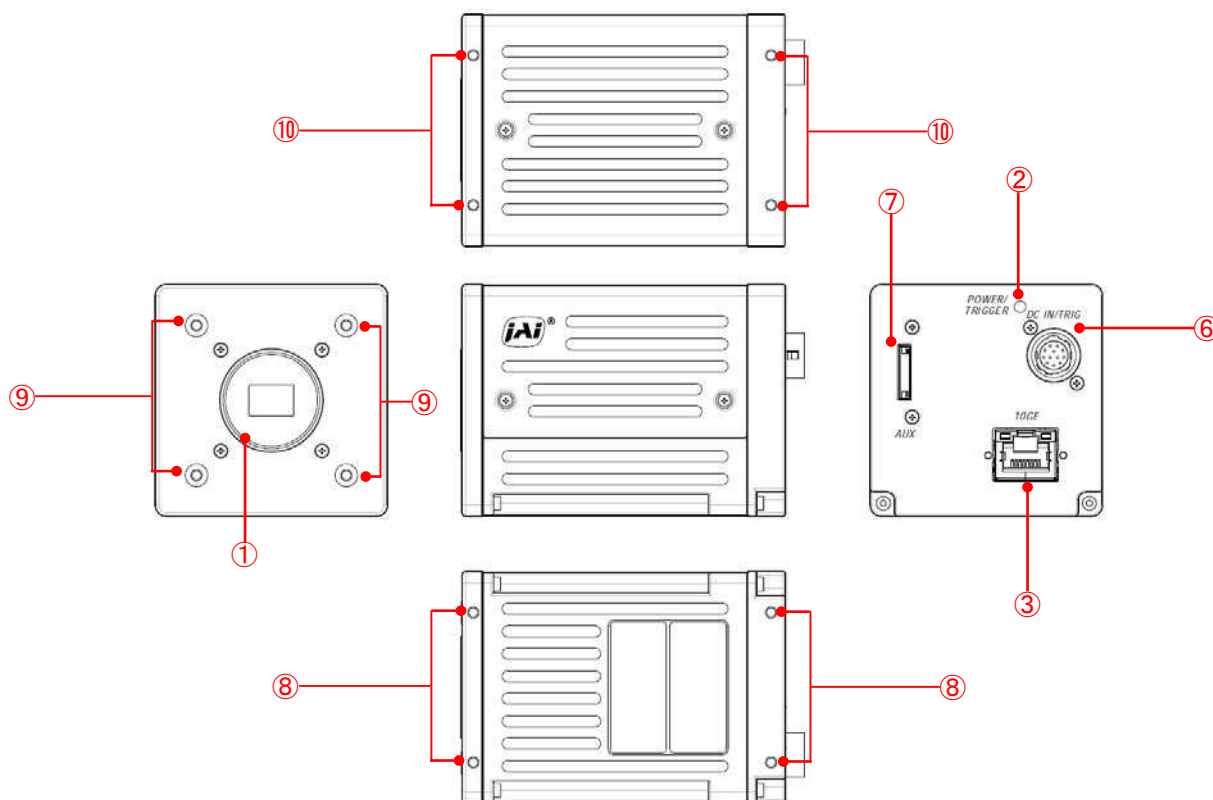

① Lens mount (C-mount)

Mount a C-mount lens, microscope adapter, etc. here.

❖ Before mounting a lens, be sure to refer to “Step 2:Connecting Devices” and confirm the precautions for attaching a lens and the supported lens types.

② POWER/TRIG LED

Indicates the power and trigger input status.

LED status and camera status

LED	Light	Status
POWER/ TRIG LED	● (Lit amber)	Camera initializing.
	● (Lit green)	Camera in operation.
	✱ (Blinking green)	During operation in trigger mode, trigger signals are being input. ❖ The blinking interval is not related to the actual input interval of the external trigger.

③ **RJ-45 connector**

The camera supports the following Ethernet standards.
(1000Base-T, 2.5GBase-T, 5GBase-T, 10GBase-T)

Depending on the Ethernet standard to be used, the cable type and the maximum cable length are limited.

For details, refer to "Step 2 Connecting Devices".

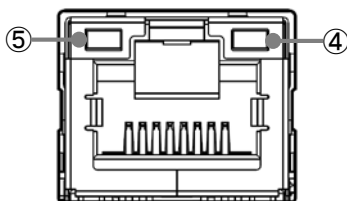

④ **LINK LED**

Indicates the link status of the network.

LED	Light	Status
LINK	● (Lights off)	Network Link is not established.
	● (Blinking green slowly)	1000Base-T Link is established. (Interval 1sec)
	● (Blinking green quickly)	2.5GBase-T Link or 5GBase-T Link is established. (Interval 200 msec)
	● (Lit green)	10GBase-T Link is established.

⑤ **ACT LED**

Indicates the network communication status.

LED	Light	Status
ACT	● (Lights off)	No network communication
	● (Blinking green)	(Tx) Network communication in progress.
	● (Blinking yellow)	(Rx) Network communication in progress.

⑥ DC IN/TRIG connector (12-pin round)

Connect the cable for a power supply (optional) or for DC IN / trigger IN here.

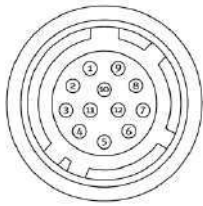

Compatible connectors

Camera side : HR10A-10R-12PB (71) (Hirose Electric or equivalent)

Cable side : HR-10A-10P-12S (plug) (Hirose Electric or equivalent)

Pin No.	Input/Output	Signal	Description
1		GND	
2	Power In	DC In	DC 10 V ~ 25 V
3	In	Opto In 2-	Line 6
4	In	Opto In 2+	
5	In	Opto In 1-	Line 5
6	In	Opto In 1+	
7	Out	Opto Out 1-	Line 2
8	Out	Opto Out 1+	
9	Out	TTL Out 1	Line 1
10	In	TTL In 1	Line 4
11	Power In	DC In	DC 10 V ~ 25 V
12		GND	

Note

Be sure to use a power supply that can support the maximum power consumption of this camera.

This camera cannot be powered by PoE (Power over Ethernet).

TTL signal specification

TTL out signal specification (Typ.)

Output voltage : Low 0.0V
 High 5.0V

Input/Output current : +/-32mA

TTL in signal specification (Typ.)

Input voltage : Low 0.0~0.8V
 High 2.0~5.5V

Caution

About Opto In. Check the recommended external input circuit diagram (reference example) and connect correctly. If you connect Opto In 1 and Opto In 2 in reverse, camera may be damaged.

Recommended external input circuit diagram (reference example)

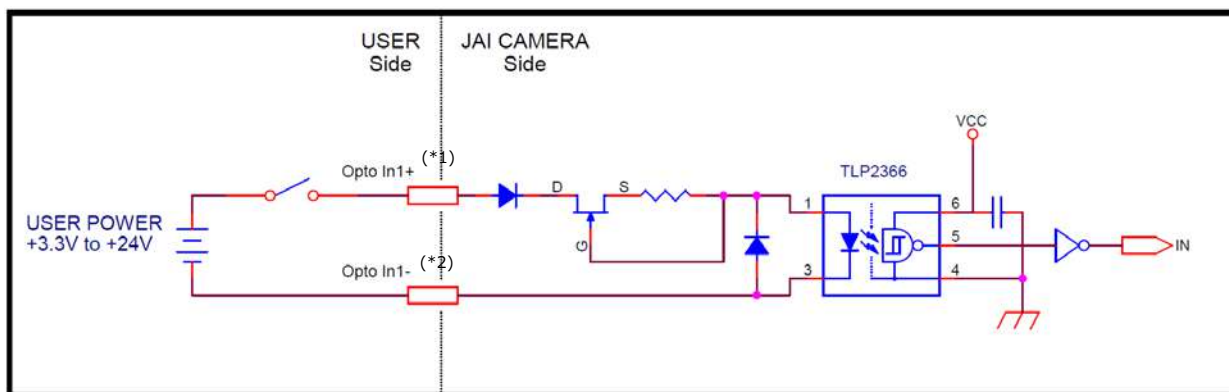

Opto In 1 :
 (*1) Pin6 (Opto In 1 +)
 (*2) Pin5 (Opto In 1 -)

Opto In 2 :
 (*1) Pin4 (Opto In 2 +)
 (*2) Pin3 (Opto In 2 -)

Recommended external output circuit diagram (reference example)

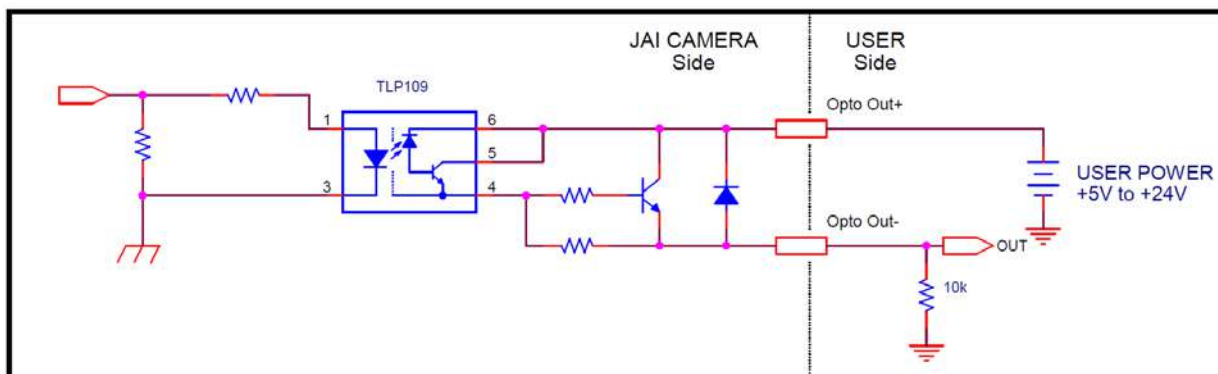

Characteristics of the recommended circuits for Opto OUT

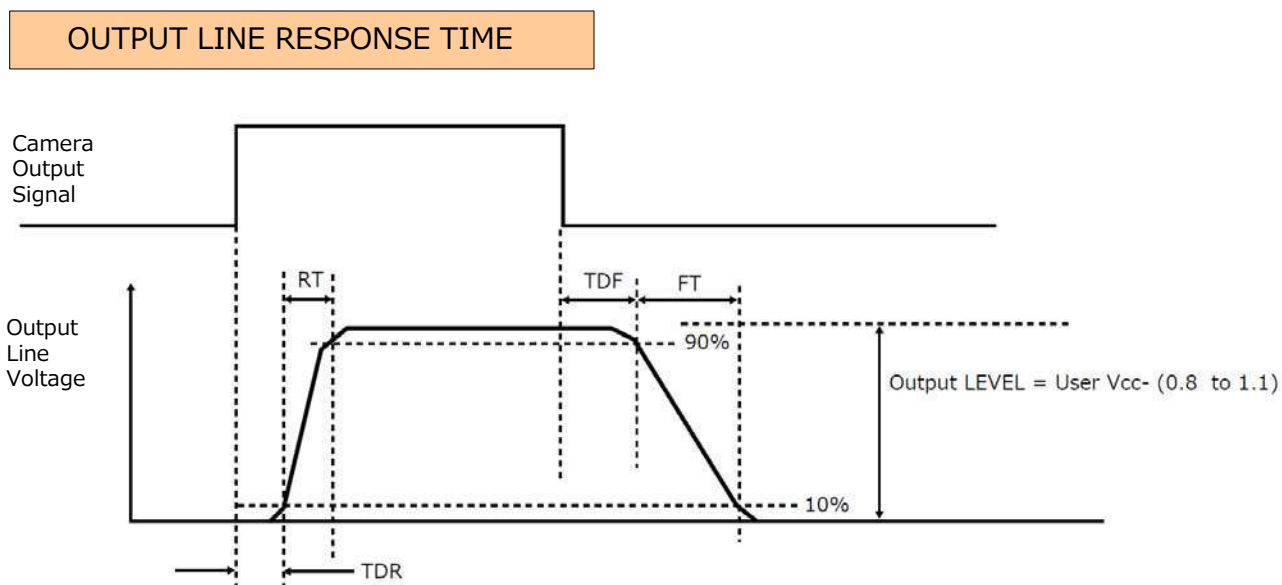

For the operating conditions of applied voltage (User Power) +12V, load resistance 10kΩ, and cable length 1m, the timing is shown in the table below.

Item	Result (Typ)
TDR(Time Delay Rise) (μs)	0.48
RT(Risc Time) (μs)	3.08
TDF(Time Delay Fall) (μs)	3.16
FT(Fall Time) (μs)	52.4

*) Since it varies depending on the applied voltage, load resistance, cable length, etc., check the actual environment before use.

Caution

Please note that the recommended load resistance of Opto output is 10 kΩ (rated 1/10 W) or more. The 270 Ω resistor shown in the circuit diagram is the MINIMUM resistance that should be used. The response speed from On (High) to Off (Low) depends on the voltage applied to Opto output and the value of the load resistance. Higher load resistance results in slower response. If the response at 10 kΩ is slower than desired, you can try reducing the load resistance in order to increase the response speed but DO NOT go below the minimum 270 Ω value.

The load resistance loss can be calculated as follows.

$$\text{load resistance loss} \approx (\text{voltage applied to Opto output})^2 / (\text{load resistance})$$

⑦ AUX connector (10-pin)

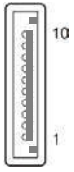

Compatible connectors

Camera side : 3260-10S3 (55) (Hirose Electric or equivalent)

Cable side : 3240-10P-C (50) (Hirose Electric or equivalent)

Pin No.	Input/Output	Signal	Description
1	Out	TTL_OUT2	Line 8
2		N.C.	
3	In	TTL_IN2	Line 10
4		N.C.	
5	GND	GND	
6		N.C.	
7	Out	Opto Out 2-	Line3
8	Out	Opto Out 2+	
9	GND	GND	
10	GND	GND	

⑧ Camera locking screw holes (M3, 5 mm depth)

Use these holes when attaching an MP-41 tripod adapter plate (optional) or mounting the camera directly to a wall or other structural system.

⑨ Camera locking screw holes (M3, 5 mm depth)

Use these holes when mounting the camera directly to a wall or other structural system.

⑩ Camera locking screw holes (M3, 5 mm depth)

Use these holes when mounting the camera directly to a wall or other structural system.

Preparation

Preparation Process

Step 1	Installing the Software (first time only) Install the software for configuring and controlling the camera (eBUS SDK for JAI) on the computer.
	↓
Step 2	Connecting Devices Connect the lens, network cable, AC adapter, computer, and other devices.
	↓
Step 3	Verifying Camera Operation Verify whether the camera is turned on and ready for use.
	↓
Step 4	Verifying the Connection between the Camera and PC Verify whether the camera is properly recognized via eBUS SDK for JAI.
	↓
Step 5	Configuring Basic Settings for the Camera Refer to the procedures for basic settings.
	↓
Step 6	Adjusting the Image Quality Refer to the procedures for adjusting the gain, white balance, and black level as examples, and adjust the image quality.
	↓
Step 7	Saving the Settings Save the current setting configurations in user memory.

Step 1: Installing the Software (first time only)

When using the camera for the first time, install the software for configuring and controlling the camera (eBUS SDK for JAI) on the computer.

❖ When you install eBUS SDK for JAI, eBUS SDK for JAI player will also be installed.

1 Download the eBUS SDK for JAI from the JAI website.
URL <https://www.jai.com/jp/support-software/jai-software>

2 Install eBUS SDK for JAI on the computer.

Caution

eBUS SDK for JAI was released in April 2018 and is the latest software for setting and controlling JAI cameras.

When JAI SDK and eBUS SDK for JAI are installed on the same machine, conflicts can occur. Therefore, JAI strongly recommends that JAI SDK is uninstalled before installing eBUS SDK for JAI.

Step 2: Connecting Devices

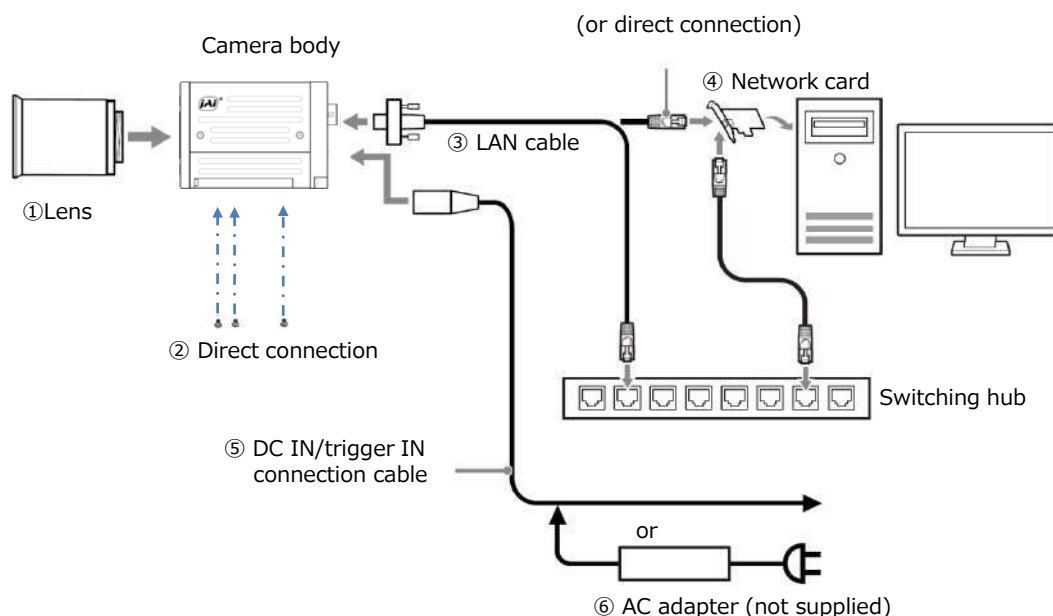

① Lens

- C-mount lenses with lens mount protrusions of 4 mm or less can be attached.

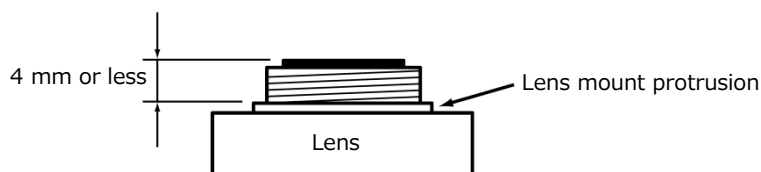

- The diagonal of the camera's CMOS image sensor is 8.89 mm, the size of standard 1/1.8-inch lenses. To prevent vignetting and to obtain the optimal resolution, use a lens that will cover the 8.89 mm diagonal. Some lens manufacturers offer lenses with an 8.89 mm format. If not, a 1/1.8-inch lens is recommended.

Caution

- The maximum performance of the camera may not be realized depending on the lens.
- Attaching a lens with a mount protrusion of 4 mm or longer may damage the lens or camera.

Note

The following formula can be used to estimate the focal length.

$$\text{Focal length} = \text{WD} / (1 + \text{W}/\text{w})$$

WD : Working distance (distance between lens and object)

W : Width of object

w : Width of sensor (7.12 mm on this camera)

② Direct connection (or MP-41 tripod adapter plate)

When mounting the camera directly to a wall or other device, use screws that match the camera locking screw holes on the camera (M3, depth: 5 mm). Use the supplied screws to attach the tripod adapter plate.

Caution

For heavy lenses, be sure to support the lens itself. Do not use configurations in which its weight is supported by the camera.

③ LAN cable

Connect a LAN cable to the RJ-45 connector.

- The camera supports the following Ethernet standards. (1000Base-T, 2.5GBase-T, 5GBase-T, 10GBase-T)
- The longest cable length varies depending on the type of LAN cable and the Ethernet standard. Below, the table shows the relationship diagram between LAN cable type and Ethernet standard. Correctly select the LAN cable type according to the Ethernet standard to be used.

■ About the longest cable length

LAN cable type Ethernet standard	Cat5e	Cat6/Cat6e	Cat6A	Cat7
1000Base-T	100m	100m	100m	100m
2.5GBase-T	100m	100m	100m	100m
5GBase-T	-	100m	100m	100m
10GBase-T	-	55m	100m	100m

- Refer to the specifications of the cable for details on its bend radius.

Caution

Secure the locking screws on the connector manually, and do not use a driver. Do not secure the screws too tightly. Doing so may wear down the screw threads on the camera. (Tightening torque: 0.147 Nm or less)

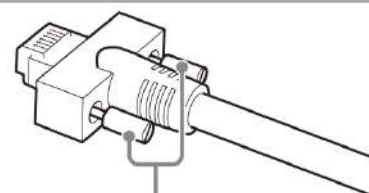

Secure manually.
Do not secure too tightly.

④ Network card

Install this in the computer that will be used to configure and operate the camera. Refer to the instruction manual of the network card, and configure settings on the computer as necessary.

⑤ DC IN / trigger IN connection cable**⑥ AC adapter (power supply)**

Connect the AC adapter and the round connector of the connection cable to the DC IN / TRIG IN connector on the camera.

Step 3: Verifying Camera Operation

When power is supplied to the camera while the necessary equipment is connected, the POWER/TRIG LED at the rear of the camera lights amber, and initialization of the camera starts. When initialization is complete, the POWER/TRIG LED lights green.

Verify whether power is being supplied to the camera by checking the rear LED.

When properly turned on

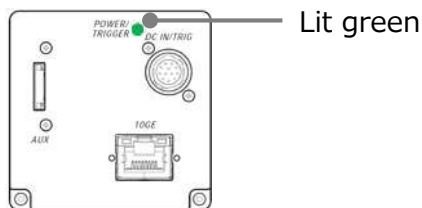

- For details on how to read the LEDs, see “LED status and camera status” in the “Parts Identification” section.

Step 4: Verifying the Connection between the Camera and PC

Verify whether the camera is properly recognized via Control Tool.

Connecting the Camera to Control Tool

1 Startup eBUS Player for JAI



eBUS Player for
JAI

eBUS Player for JAI startup screen appears.

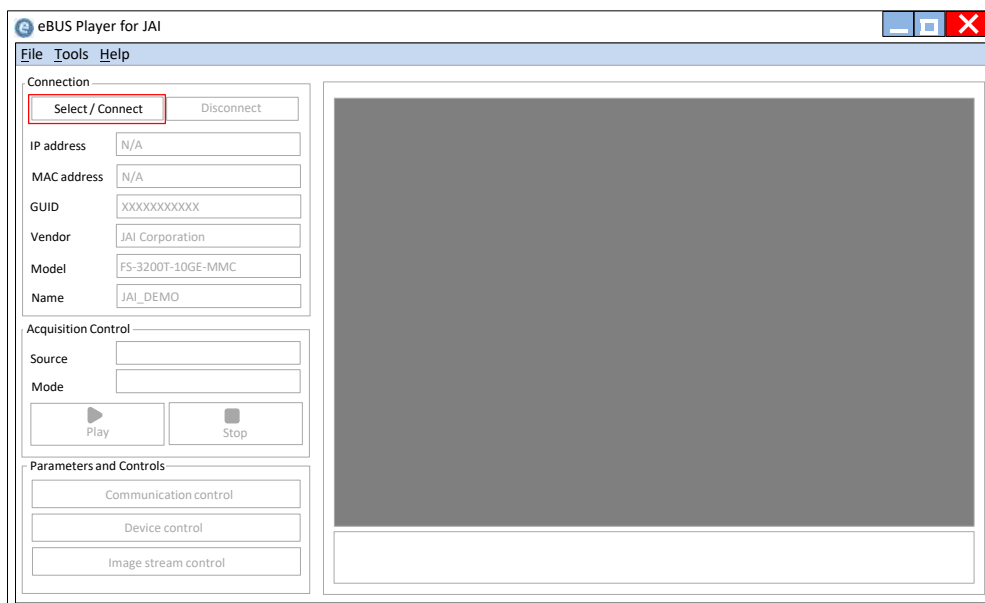

2 Select the camera you want to configure.

Push **Select / Connect** button

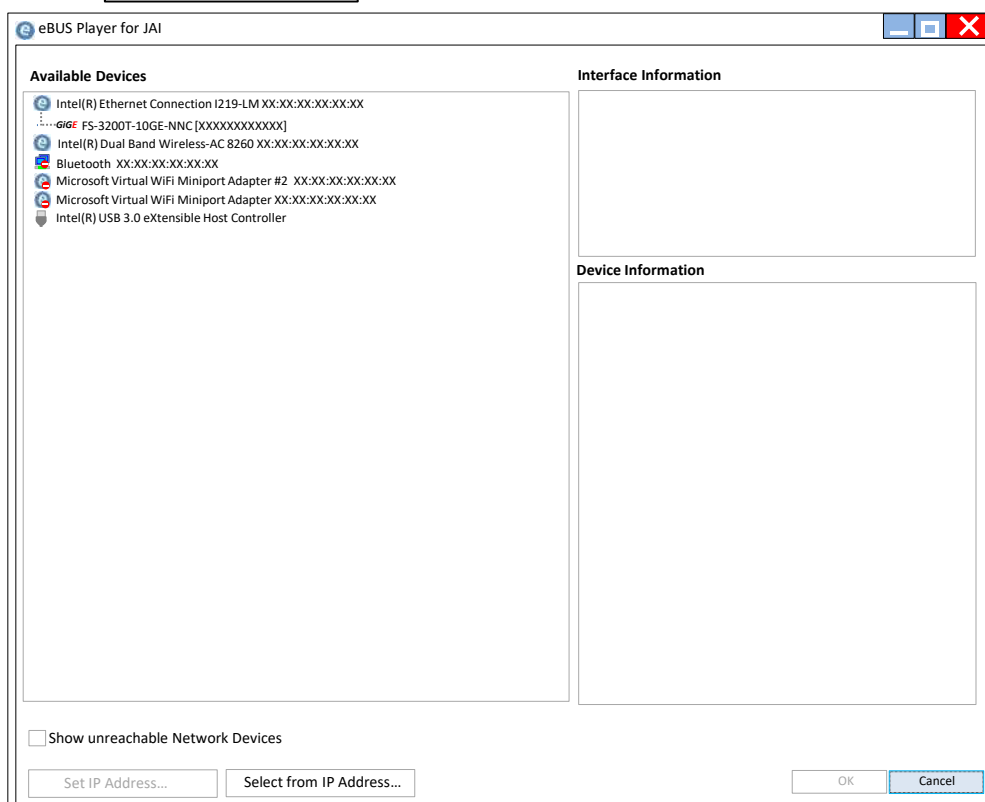

The connected camera is listed.
Please select one camera.

3 Check that the settings of the selected camera are displayed.

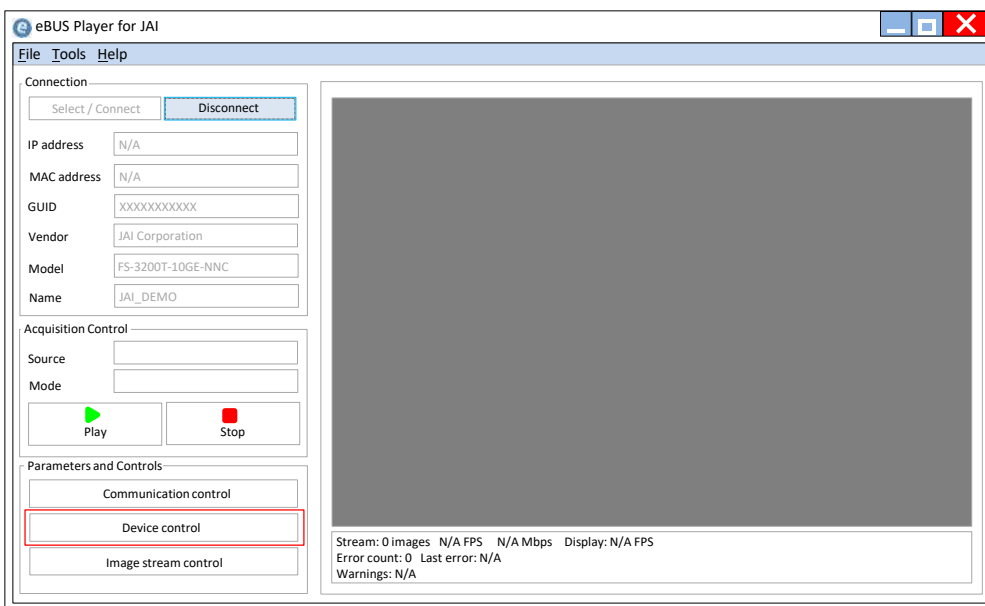

Push the Device control button.
The screen shown below will be displayed. In this window you can adjust various settings of the camera.

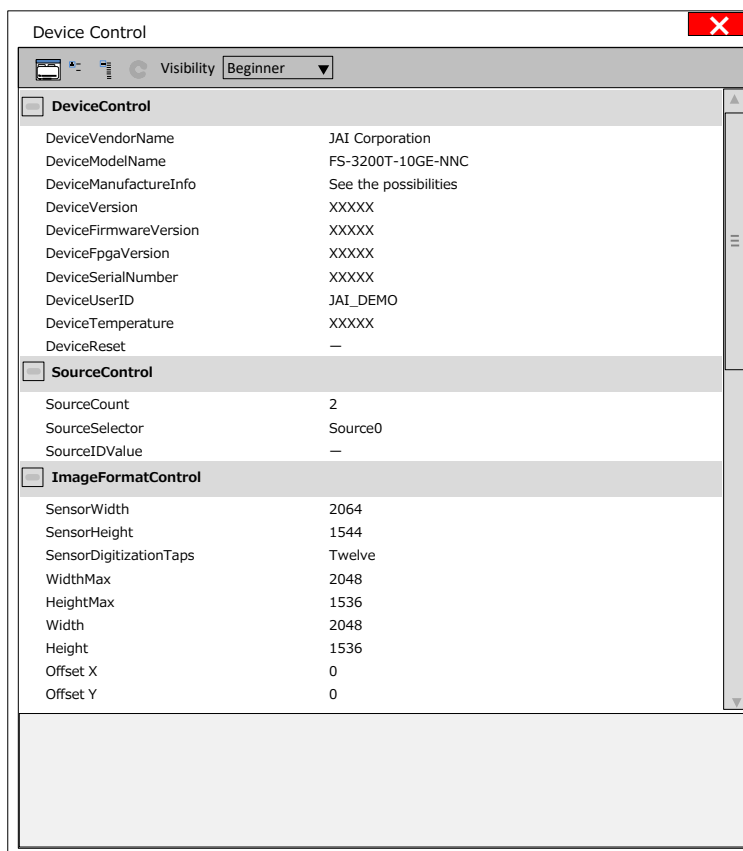

This completes the procedure for verifying whether the camera is properly recognized and whether control and settings configuration are possible.

Step 5 Configuring Basic Settings for the Camera

This section explains how to change settings by describing the procedure for changing the output format as an example.

(This camera has three image sensors. This chapter will explain how to set Sensor 0 / Stream 0 for images. How to set Sensor 1 / Stream 1 and Sensor 2 / Stream 2 for images will be explained in the next chapter and subsequent chapters.)

Set the output format

Set the size, position, and pixel format of the image to be captured.
The factory default settings are as follows. Change the settings as needed.

The factory default settings (Sensor 0/Stream 0)

Item	Default	
ImageFormatControl	Width	2048
	Height	1536
	OffsetX	0
	OffsetY	0
	PixelFormat	Mono8 / BayerRG8

1 The following example shows how to change the [ImageFormatControl] -> [Width] setting.

If you select the [Width] item, you can change the value as shown below.

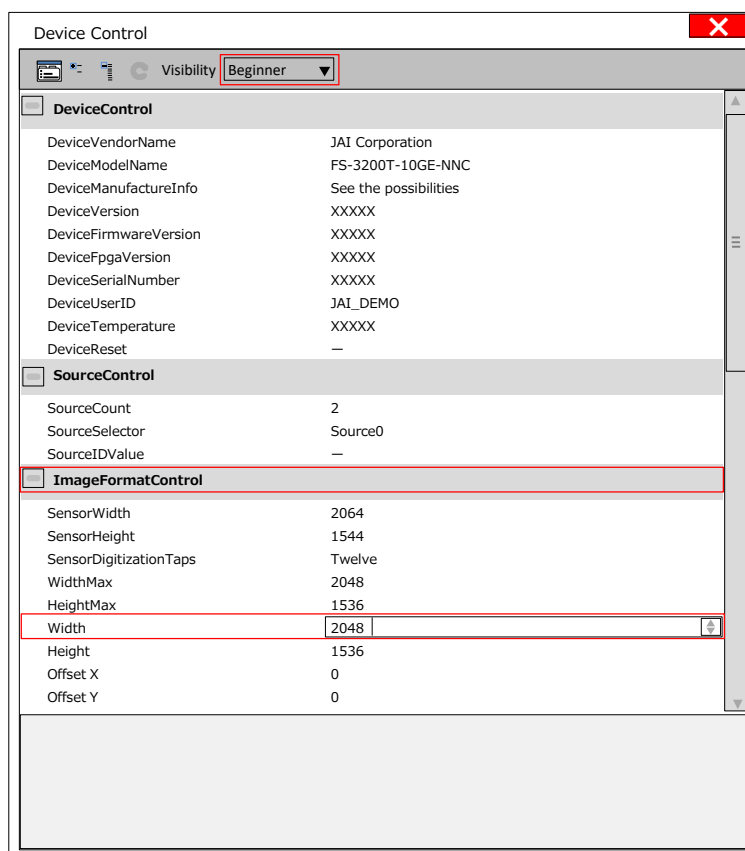

Note

Depending on the setting items, you need to change the visibility.
If necessary, switch between Visibility (Beginner / Expert / Guru).

Step 6: Adjusting the Image Quality

Display the camera image and adjust the image quality.

Displaying the Image

Display the image captured by the camera.

When you push [Play] button, the camera image appears in right area.

*) By default settings, the video in the visible region are displayed.

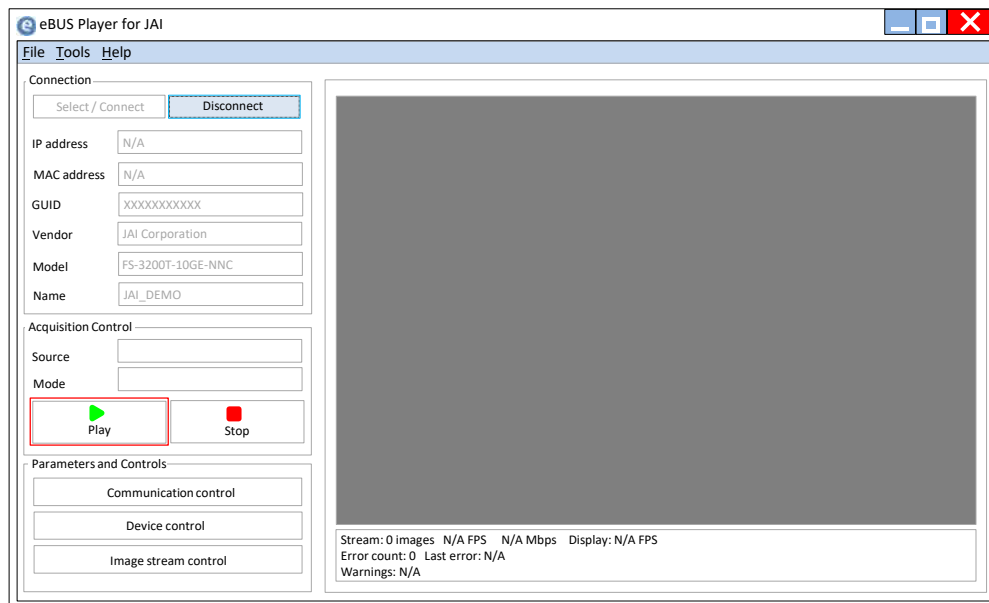

Note

It is recommended to set [GevGVCPPendingAck] in [TransportLayerControl] to True. When a time-consuming process such as white balance is performed, this camera returns an Ack response when the process is completed.

In this case, some camera control software may cause a timeout error without waiting for an Ack response from the camera. When the [GevGVCPPendingAck] setting is enabled, if a time-consuming process is performed, the camera immediately returns a Pending Ack response and returns an Ack response when the processing is completed. The Timeout errors are prevented.

Adjusting the Gain

To adjust the image quality

The Visibility must be changed from [Beginner] to [Guru].

Adjust the sensitivity via the analog gain (i.e., master gain).

For details on gain control, see "Gain Control" in the "Main Functions" section.

■ Manual adjustment

1 Expand [AnalogControl], and set [GainAuto] to [Off].

([Off] is default setting.)

2 Configure the gain.

- ① Expand [AnalogControl], and select the gain you want to configure in [GainSelector].
[AnalogAll] (master gain), [DigitalRed]* (digital R gain), and [DigitalBlue]* (digital B gain) can be configured.
- ② Configure the gain value in [Gain].
 - [AnalogAll] (master gain) can be set to a value from x1 to x16 the analog gain value. The resolution is set in about 0.1dB steps. Values are configured by multipliers.
 - The [DigitalRed]* (digital R gain) and [DigitalBlue]* (digital B gain) can be set to a value from x0.447 to the [AnalogAll] (master gain) value. The resolution is set in 0.000122 steps. Values are configured by multipliers.

Adjusting the White Balance *) Bayer color only

Adjust the white balance using the automatic adjustment function.

■ Automatic white balance adjustment

1 Place a white sheet of paper or similar object under the same lighting conditions as the intended subject, and zoom in to capture the white.

White objects near the subject, such as a white cloth or wall, can also be used. Be sure to prevent the high-intensity spot lights from entering the screen.

2 Select the [BalanceWhiteAuto] tab, and select [Continuous] or [Once] for the adjustment method.

The white balance is automatically adjusted.

Note

[Continuous] and [Once] adjust the white balance by gain adjustment.

Adjusting the Black Level *) Red & Blue are for Bayer color only

1 Expand [AnalogControl], and select the black level you want to configure in [BlackLevelSelector].

[DigitalAll] (master black), [DigitalRed]* (digital R), and [DigitalBlue]* (digital B) can be configured.

2 Specify the adjustment value in [BlackLevel].

Step 7: Saving the Settings

The setting values configured in the player (eBUS SDK for JAI) will be deleted when the camera is turned off. By saving current setting values to user memory, you can load and recall them whenever necessary. You can save up to three sets of user settings in the camera. (User Set1 to 3)

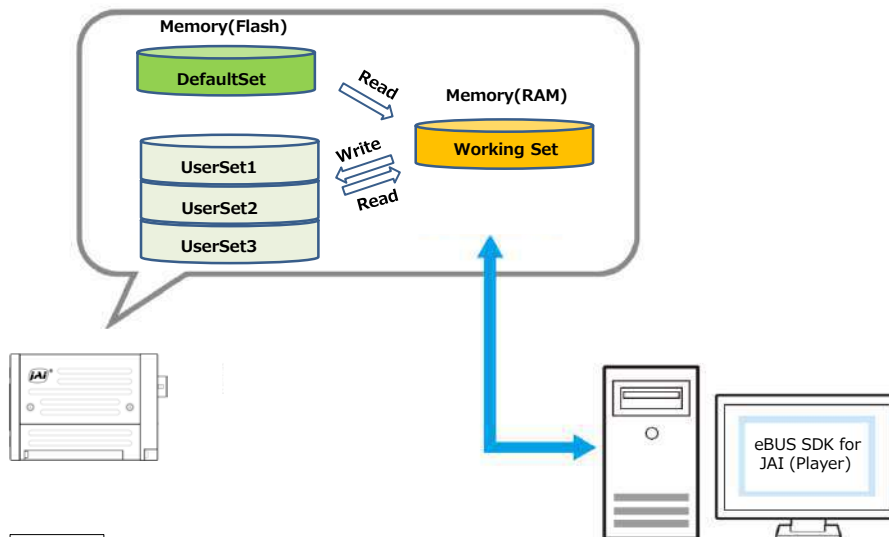

Note

Changes to settings are not saved to the computer (eBUS SDK for JAI).

■ To save user settings

- 1** Stop image acquisition.
- 2** Expand [UserSetControl], and select the save destination ([UserSet1] to [UserSet3]) in [UserSetSelector].

Note

The factory default setting values are stored in [Default] and cannot be overwritten.

Caution

Settings can only be saved when image acquisition on the camera is stopped.

- 3** Select [UserSetSave], and click [Execute 'UserSetSave' Command].

The current setting values are saved as user settings.

■ To load user settings

- 1** Stop image acquisition.
User settings can only be loaded when image capture on the camera is stopped.
- 2** Select the settings to load (UserSet1 to UserSet3) in [UserSetSelector].
- 3** Select [UserSetLoad], and click [Execute 'UserSetLoad' Command].

The selected user settings are loaded.

Three stream transmission

This camera has three image sensors, which provide three images. Video captured by the three image sensors is output from the camera as three streams over a single GigE Vision interface.

Each stream requires a destination IP address and a destination port number in order for its image data to be transmitted to the host PC.

In the previous chapter, the image data from Sensor 0/Stream 0 was displayed without needing to set any stream transmission parameters. This is because the data reception settings of the eBUS Player for JAI are automatically set for Sensor 0/Stream 0 as soon as the camera is connected.

However, the stream transmission settings for 2nd and 3rd channels (Sensor 1/Stream 1, Sensor 2/Stream 2) are not automatically set (see below). Unless these settings are provided, the image data from these two streams will not be received by the host PC. Only a single stream will be transmitted.

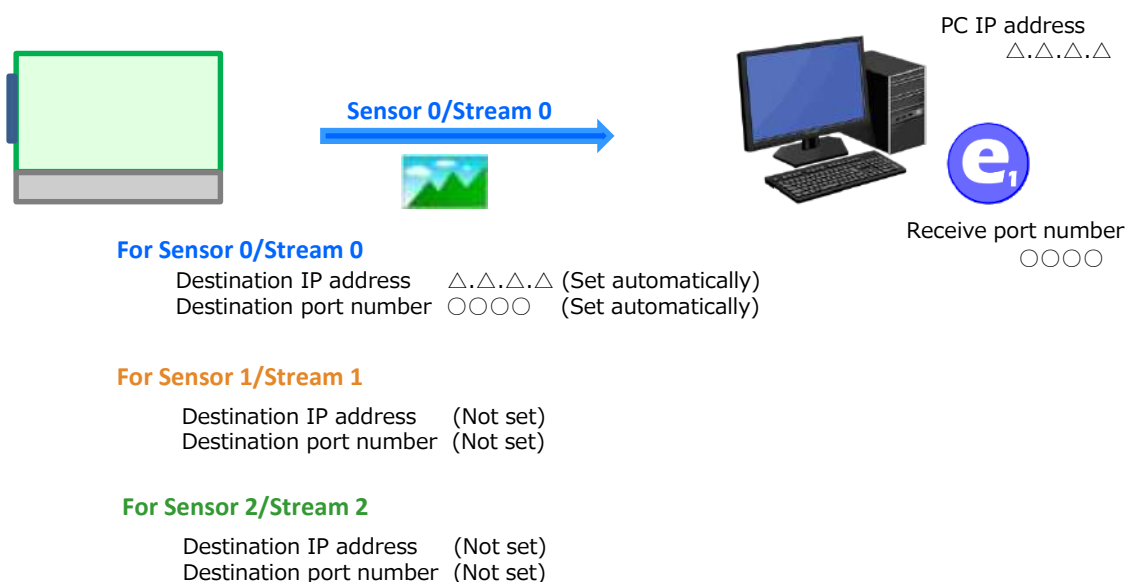

You can change which stream is transmitted and viewed in the eBUS Player for JAI by switching the settings for Sensor 0/Stream 0 to one of the other sensors/streams. This procedure is described in the next section.

To transmit all three streams simultaneously requires manually setting the destination information for two of the streams, as will be explained in the following chapter. You can display all three streams at the same time by starting three instances of the eBUS Player for JAI.

Display video in the near-infrared region

Previous sections have described how to output and control video in 1st channel (Sensor 0/Stream 0). This is the default stream when the eBUS Player for JAI is connected to a camera.

By swapping the destination IP address and destination port number between Sensor 0/Stream 0 and one of the other two channels you can easily change the stream being displayed and the transmission to the host PC as shown below.

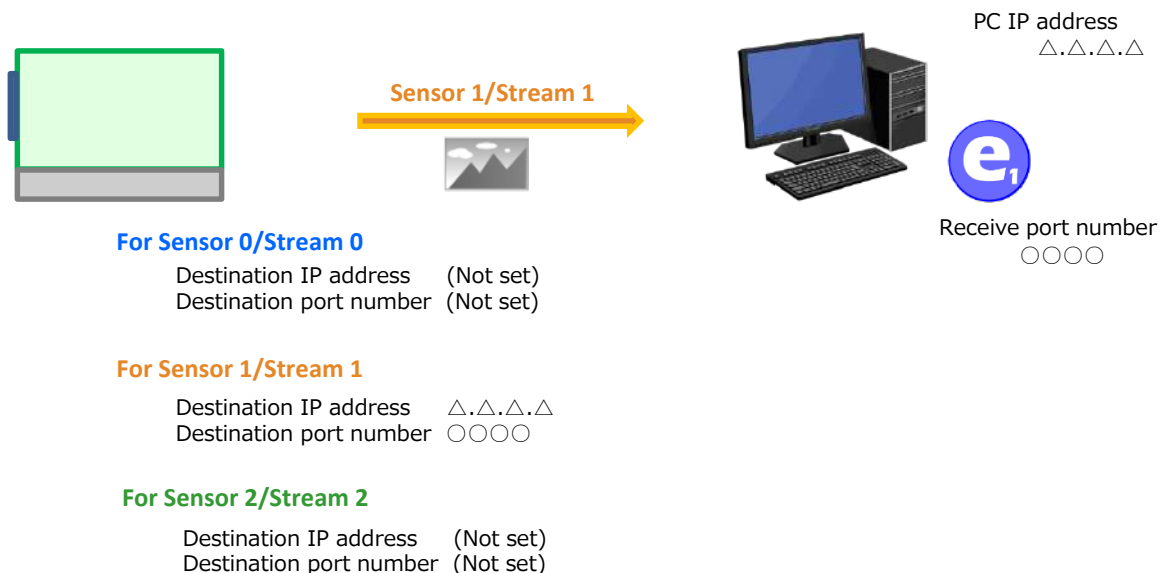

The following steps describe how to switch the transmission and display to Sensor 1 /Stream 1:

- a. Check the Sensor 0/Stream 0 settings.
 - Select "0" in [TransportLayerControl]->[GevStreamChannelSelector].
 - Check the destination port number in [GevSCPHostPort] setting. (Example: Y0YYY)
 - Check the destination IP address in [GevSCDA] setting. (Example: X0.XX.XX.XX)
- b. Change the Sensor 1/Stream 1 settings.
 - Select "1" in [TransportLayerControl]->[GevStreamChannelSelector].
 - Set "Y0YYY" to [GevSCPHostPort].
 - Set "X0.XX.XX.XX" to [GevSCDA].
- c. Change the Sensor 0/Stream 0 settings.
 - Select "0" in [TransportLayerControl]->[GevStreamChannelSelector].
 - Set "0" to [GevSCPHostPort].
 - Set "0.0.0.0" to [GevSCDA].

Be sure to select "Source 1" in [SourceControl]-> [SourceSelector], before changing the settings related to Sensor 1/Stream 1. For Sensor 2 / Stream 2, select "Source 2."

[SourceControl]->[SourceSelector]

Source0: When setting Sensor 0/Stream 0.

Source1: When setting Sensor 1/Stream 1.

Source2: When setting Sensor 2/Stream 2.

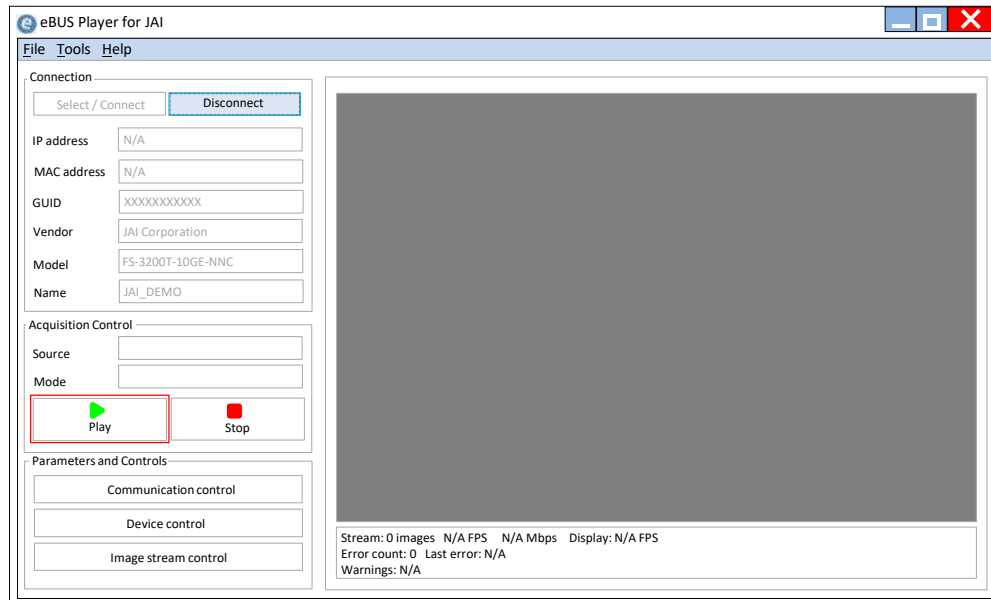

The video display target has now been switched to Sensor 1/Stream 1. Push the [Play] button to display video in the near infrared region (Sensor 1/Stream 1).

*) When the settings are restored in Source 0, or if the camera is disconnected and reconnected, the video in the visible region (Sensor 0/Stream 0) is once again displayed.

Simultaneous transmission/display of all three streams

As noted previously, each of the camera's three streams requires a destination IP address and a destination port number in order for its image data to be transmitted to the host PC. This section will first explain how to display all three streams (1st channel + 2nd channel + 3rd channel) simultaneously while they are also being transmitted to the host PC.

- Open a first instance of the eBUS Player for JAI and connect it to the camera as described previously. You can press play to make sure that the video from the visible channel can be displayed.
- Stop the video on the first eBUS Player for JAI before continuing.
- Without closing the first eBUS Player for JAI, start a second eBUS Player for JAI.
- In the second eBUS Player for JAI, execute [Tools]->[Setup]. (Do not connect with the camera yet).

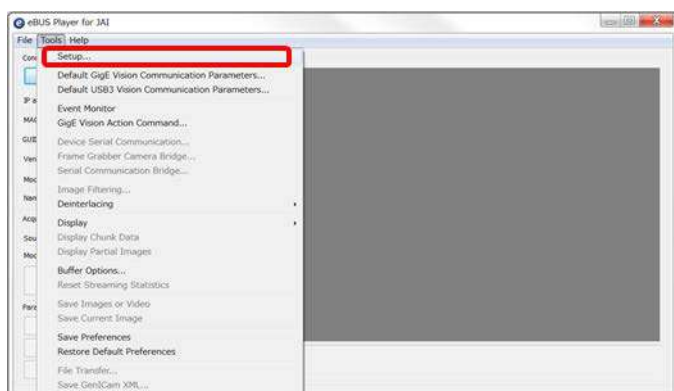

- Change the following two settings on the Setup menu.

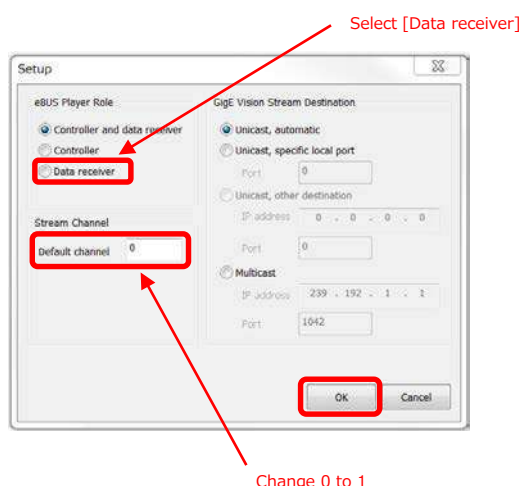

f. Now connect to the camera.

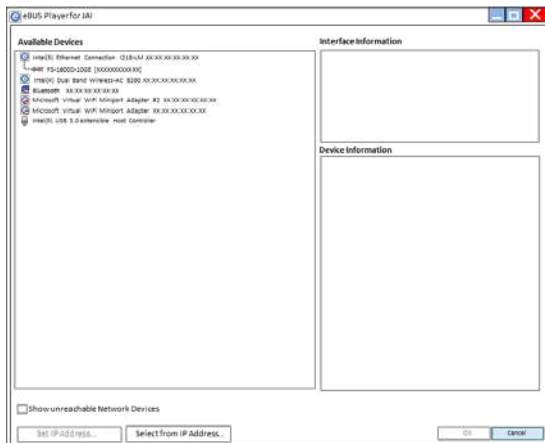

g. Repeat steps C, D, E, & F to open, configure, and connect a third eBUS Player for JAI. When changing the settings on the Setup menu, be sure to change Stream Channel-> Default Channel to "2".

We can now change the settings in the Transport Layer Control section of the first eBUS Player for JAI to achieve simultaneous three-stream transmission/display.

h. Check the automatically assigned receiving port number and local IP address of the second eBUS Player for JAI by clicking on [Image Stream Control] and scrolling to the [Connection] section.

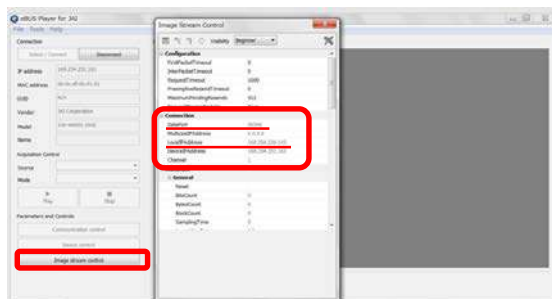

Example
 Receiving DataPort = 56596
 Receiver side LocalIP Address = 169.254.226.143

i. Then in the first eBUS Player for JAI, click on [Device Control] and scroll to [TransportLayerControl].

- Select "1" in [GevStreamChannelSelector]
- Set the value of [GevSCPHostPort] to the DataPort value of the second eBUS Player for JAI
- Set the value of [GevSCDA] to the LocalIP Address of the second eBUS Player for JAI. (Note: because all streams are connected via a single cable to the same NIC, the LocalIP Address is generally the same for all streams)

- j. Now, check the automatically assigned receiving port number and local IP address of the third eBUS Player for JAI by clicking on [Image Stream Control] and scrolling to the [Connection] section.
- k. Again, in the first eBUS Player for JAI, click on [Device Control] and scroll to [TransportLayerControl].
 - Select "2" in [GevStreamChannelSelector]
 - Set the value of [GevSCPHostPort] to the DataPort value of the third eBUS Player for JAI
 - Set the value of [GevSCDA] to the LocalIPAddress of the third eBUS Player for JAI.
- l. Now that settings for all three streams have been defined, we can push the [Play] button in the first eBUS Player for JAI. The video for the visible spectrum (Sensor0/Stream 0) will be displayed in the first eBUS Player for JAI. The NIR video from Sensor 1/Stream 1 will be displayed in the second player, and the NIR video from Sensor 2/Stream 2 will be displayed in the third player. All three streams will be transmitted to the host PC via the designated port assignments.

The first eBUS Player for JAI

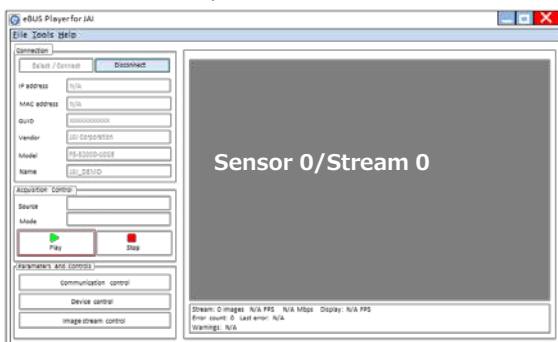

Camera settings can be checked / changed

The second eBUS Player for JAI

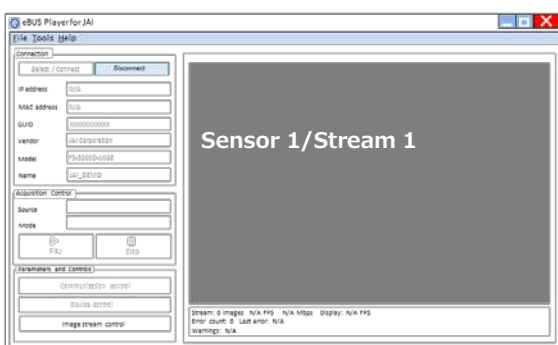

Only receive and display images

The third eBUS Player for JAI

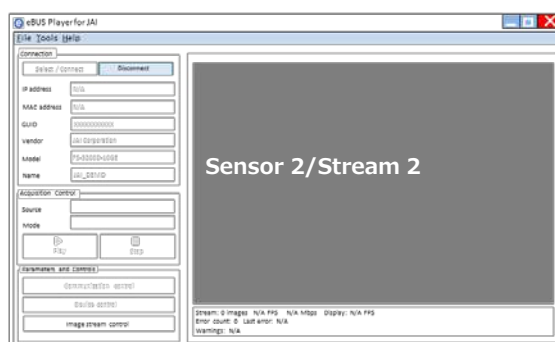

Only receive and display images

Important Reminders!

- It is not necessary to set the stream transmission destination on the camera side to receive the image of Sensor 0/Stream 0, but it is necessary to set it to receive the image of Sensor 1/Stream 1 and Sensor 2/Stream 2.
- The second and third eBUS Player for JAI must be started as Data Receivers.
- Only the first eBUS Player for JAI can change the camera settings.

Main Functions

Three Image Sensors

This camera has three image sensors as shown below. Video in the visible region and video in the near-infrared region x 2 can be output as a triple stream.

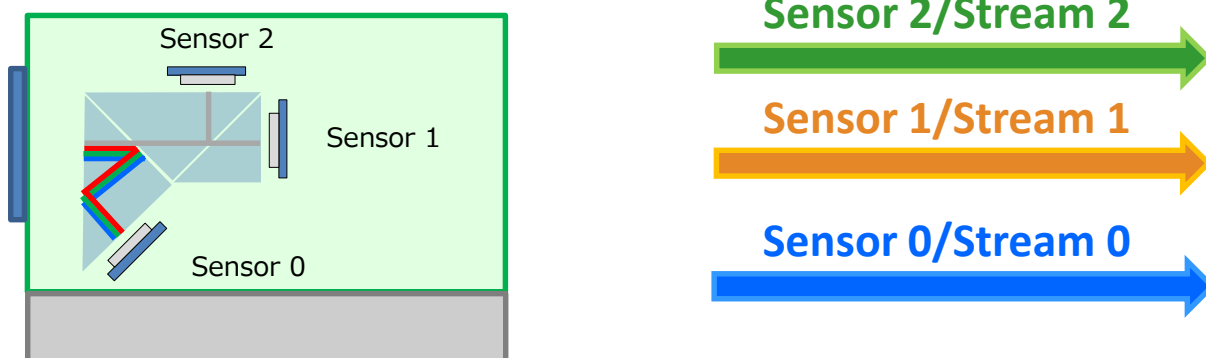

■ Set imaging conditions for each image sensor individually.

The settings below can be managed separately for Sensor 0/Stream 0, Sensor 1/Stream 1 and Sensor 2/Stream 2.

In order to do setting individually, set target beforehand with [SourceControl]-> [SourceSelector].

- Source0 : When setting Sensor 0/Stream 0.
- Source1 : When setting Sensor 1/Stream 1.
- Source2 : When setting Sensor 1/Stream 1.

After that, set any items.

c) ImageFormatControl	Configure image format settings.
SensorDigitizationBits	It shows how many bits the sensor is operating.
WidthMax	Display the maximum image width.
HeightMax	Display the maximum image height.
Width	Set the image width.
Height	Set the image height.
OffsetX	Set the horizontal offset.
OffsetY	Set the vertical offset.
BinningHorizontalMode	Set the mode for horizontal binning.
BinningHorizontal	Set the number of pixels in the horizontal direction for which to perform binning.
BinningVerticalMode	Set the mode for vertical binning.
BinningVertical	Set the number of pixels in the vertical direction for which to perform binning.
PixelFormat	Set the pixel format.
TestPattern	Select the test image.

d) AcquisitionControl	Configure image capture settings.
AcquisitionMode	Select the image capture mode.
AcquisitionFrameCount	In [MultiFrame] mode, set the number of frames to capture.
AcquisitionFrameRate	Display the frame rate as a frequency. (unit: Hz)
TriggerSelector	Select the trigger operation.
TriggerMode	Select the trigger mode.
TriggerSoftware	Execute the software trigger.
TriggerSource	Select the trigger signal source.
TriggerActivation	Select the polarity of the trigger signal (i.e., location of signal at which trigger is applied).
TriggerOverlap	Select the trigger overlap operation.
TriggerDelay	Set the time of exposure start from trigger input. (unit: μ s)
ExposureMode	Select the exposure mode.
ExposureTime	Set the exposure time. (μ s)
ExposureAuto	Set whether to enable auto exposure.
ExposureModeOption	Set whether to enable RCT mode.
AcquisitionSyncMode	Set an AcquisitionSyncMode.
e) AnalogControl	Configure analog control settings.
GainSelector	Select the gain to configure.
Gain	Set the gain value for the gain setting selected in [GainSelector].
GainAuto	Enable/disable gain auto adjustment.
BlackLevelSelector	Select the black level to configure.
BlackLevel	Set the black level value.
BalanceWhiteAuto	Enable/disable auto white balance.
BalanceWhiteAutoAreaSelector	Select the area for which to configure [BalanceWhiteAutoAreaEnable].
BalanceWhiteAutoAreaEnable	Enable/disable the photometry area selected in [BalanceWhiteAutoAreaSelector].
BalanceWhiteAutoAreaEnableAll	Enable/disable BalanceWhiteAuto with all areas designated as photometry areas.
BalanceWhiteAutoSpeed	Set the response speed for BalanceWhiteAuto. (8 is the fastest)
BalanceWhiteAutoResult	Display the results of BalanceWhiteAuto.
Gamma	Set the gamma value.
LUTMode	Select the LUT mode.
f) AutoLevelControl	Configure AutoLevelControl.
ALCReference	Set the target level for ALC. (unit: %)
ALCAreaSelector	Select the area for which to configure [ALCAreaEnable].
ALCAreaEnable	Enable/disable the photometry area selected in [ALCAreaSelector].
ALCAreaEnableAll	Enable/disable ALC with all areas designated as photometry areas
ALCControlSpeed	Set the response speed for ALC. (8 is the fastest.)
AutoControlStatus	Allows confirmation of the current operation area during ALC operation.
ExposureAutoControlMin	Set the minimum value for the ExposureTime control range
ExposureAutoControlMax	Set the maximum value for the ExposureTime control range
GainAutoControlMin	Set the minimum value for the GainAuto control range
GainAutoControlMax	Set the maximum value for the GainAuto control range
g) LUTControl	Configure LUT settings.
LUTSelector	Select the LUT channel to control.
LUTIndex	Set the LUT index table number.
LUTValue	Set the LUT value.

i) CounterAndTimerControl		Configure counter settings.
CounterSelector		Select the counter.
	CounterEventSource	Assign the counter event signal for which you want to read the count value to a dedicated counter, and read the value.
	CounterEventActivation	Set the count timing.
	CounterReset	Reset the counter.
	CounterValue	Display the count value.
	CounterStatus	Display the counter status.
m) SequencerControl		Configure sequencer settings.
SequencerMode		Enable/disable [SequencerMode].
SequencerModeSelect		Select the sequencer mode.
SequencerSetSelector		Select the index number to configure.
	SequencerWidth	Set the width of the selected SequencerIndex.
	SequencerHeight	Set the height of the selected SequencerIndex.
	SequencerOffsetX	Set the horizontal offset value for the selected SequencerIndex.
	SequencerOffsetY	Set the vertical offset value for the selected SequencerIndex.
	SequencerBinningHorizontal	For the selected SequencerIndex, set the number of pixels in the horizontal direction for which to perform binning.
	SequencerBinningVertical	For the selected SequencerIndex, set the number of pixels in the vertical direction for which to perform binning.
	SequencerFrameCount	Set the FrameCount value for the selected SequencerIndex.
	SequencerExposureTime	Set the exposure time for the selected SequencerIndex.
	SequencerGainAnalogAll	Set the GainAnalogAll value.
	SequencerGainDigitalRed	Set the DigitalRed Gain value for the selected SequencerIndex.
	SequencerGainDigitalBlue	Set the DigitalBlue Gain value for the selected SequencerIndex.
	SequencerBlackLevelAll	Set the BlackLevelAll value for the selected SequencerIndex.
	SequencerLutEnable	Set the LutEnable value for the selected SequencerIndex.
	SequencerSetNext	Set the next index to be displayed for the selected SequencerIndex.
SequencerRepetition		Set the repeat count for the sequencer.
SequencerSetActive		Displays the sequencer set number.
SequencerSetStart		Specify the first index number to switch to when starting [TriggerSequencerMode].
SequencerCommandIndex		Set this to change the SequencerIndex. (Enabled only for CommandSequencer.)
SequencerReset		In [TriggerSequencerMode], reset the current index number to the number configured in [SequencerSetStart].
n) ChunkDataControl		Configure chunk control settings.
ChunkModeActive		Set whether to enable ChunkData
ChunkBinningHorizontal		(ChunkID 2022h : DataType Float)
ChunkBinningVertical		(ChunkID 2023h : DataType Float)
ChunkTimestamp		(ChunkID 2014h : DataType Float)
ChunkLineStatusAllOnExposureStart		(ChunkID 2015h : DataType String)
ChunkLineStatusAllOnFVALStart		(ChunkID 2016h : DataType String)
ChunkCounterSelector		Select the counter to display the ChunkCounterValue.
	ChunkCounterValue	CounterValue[FrameTrigger]: 200Eh CounterValue[ExposureStart]: 200Fh CounterValue[SensorReadout]: 2010h
ChunkExposureTime		(ChunkID 2004h : DataType Float)
ChunkGainSelector		Select the Gain to display the ChunkGain.
	ChunkGain	Gain[DigitalRed]: 2006h Gain[AnalogAll]: 201Fh Gain[DigitalBlue]: 2007h
ChunkBlackLevelSelector		Select the BlackLevel to display the ChunkBlackLevel.
	ChunkBlackLevel	BlackLevel[DigitalRed]: 2009h BlackLevel[DigitalAll]: 2008h BlackLevel[DigitalBlue]: 200Ah
ChunkDeviceSerialNumber		(ChunkID 2017h : DataType String)
ChunkDeviceTemperatureSelector		Select the device to display the ChunkDeviceTemperature.
	ChunkDeviceTemperature	(ChunkID 2019h : DataType Float)
ChunkDeviceUserID		(ChunkID 2018h : DataType String)

r) Shading	Configure shading correction settings.
ShadingCorrectionMode	Select the shading correction method.
ShadingMode	Set the area to which to save shading correction data.
PerformShadingCalibration	Execute shading correction.
ShadingDetectResult	Display the shading correction results.
s) Correction	Correct variations due to sensors and lenses.
VideoProcessBypassMode	Enable/disable VideoProcessBypass mode.
EdgeEnhancer	
EdgeEnhancerEnable	Enable/disable EdgeEnhancer.
EdgeEnhancerLevel	Set the Level for EdgeEnhancer.
ColorEnhancer	
ColorEnhancerEnable	Enable/disable ColorEnhancer.
ColorEnhancerSelector	Index for advanced ColorEnhancer settings.
ColorEnhancerValue	Specify the ColorEnhancer emphasis levels for each color component.
t) BlemishControl	Configure settings for JAI white blemish correction.
BlemishEnable	Enable/disable blemish correction.
BlemishDetect	Execute blemish detection.
BlemishDetectThreshold	Set the blemish detection threshold.
BlemishStore	Stores the Blemish data that to be entered by BlemishCompensationPositionX and BlemishCompensationPositionY.
BlemishCompensationIndex	Select the index for the target blemish coordinates (BlemishDataPosition X/Y).
BlemishCompensationPositionX	Display the X coordinate (horizontal pixel position) of the target blemish selected in [BlemishCompensationIndex].
BlemishCompensationPositionY	Display the Y coordinate (vertical pixel position) of the target blemish selected in [BlemishCompensationIndex].
BlemishCompensationDataClear	Delete detected or specified blemish information selected in [BlemishCompensationIndex].
BlemishCompensationNumber	Display the number of target blemishes.
u) MultiROIControl	Configure settings for Multi ROI.
MultiRoiMode	Enable/disable Multi Roi.
MultiRoiIndex	Select the index for the Multi Roi mode.
MultiRoiWidth	Set the width for the selected Multi Roi index.
MultiRoiHeight	Set the height for the selected Multi Roi index.
MultiRoiOffsetX	Set the horizontal offset for the selected Multi Roi index.
MultiRoiOffsetY	Set the vertical offset for the selected Multi Roi index.
MultiRoiHorizontalEnableNumber	Set the maximum number of valid horizontal index numbers.
MultiRoiVerticalEnableNumber	Set the maximum number of valid vertical index numbers.

■ Two operating modes

There are two operating modes.

Acquisition SyncMode : A mode to synchronize Acquisition operations of all three sensors/streams.

Acquisition AsyncMode : A mode to operate Acquisition operations of Sensor 0/Stream 0, Sensor 1/Stream 1, and Sensor 2/Stream 2 asynchronously.

■ Acquisition SyncMode

The operation mode is set by [AcquisitionControl]-> [AcquisitionSyncMode].

In Acquisition synchronous mode, Any items (yellow items in the table below) are common settings for all three sensors/streams.

(Except for the two items in [ExposureTime] and [ExposureAuto] in the [AcquisitionControl] setting.)

d) AcquisitionControl		Configure image capture settings.
AcquisitionMode		Select the image capture mode.
AcquisitionFrameCount		In [MultiFrame] mode, set the number of frames to capture.
AcquisitionFrameRate		Display the frame rate as a frequency. (unit: Hz)
TriggerSelector		Select the trigger operation.
TriggerMode		Select the trigger mode.
TriggerSoftware		Execute the software trigger.
TriggerSource		Select the trigger signal source.
TriggerActivation		Select the polarity of the trigger signal (i.e., location of signal at which trigger is applied).
TriggerOverlap		Select the trigger overlap operation.
TriggerDelay		Set the time of exposure start from trigger input. (unit: μ s)
ExposureMode		Select the exposure mode.
ExposureTime		Set the exposure time. (μ s)
ExposureAuto		Set whether to enable auto exposure.
ExposureModeOption		Set whether to enable RCT mode.
AcquisitionSyncMode		Set an AcquisitionSyncMode.

In addition, other items listed in the table below are common settings.

m) SequencerControl		Configure sequencer settings.
SequencerMode		Enable/disable [SequencerMode].

Also, the two commands [AcquisitionStart] and [AcquisitionStop] are common commands regardless of the operation mode. When [AcquisitionStart] is executed, [AcquisitionStart] is executed for Sensor 0/Stream 0, Sensor 1/Stream 1 and Sensor 2/Stream 2.

■ Acquisition AsyncMode

The operation mode is set by [AcquisitionControl]-> [AcquisitionSyncMode].

In Acquisition asynchronous mode, set any conditions for Sensor 0/Stream 0, Sensor 1/Stream 1 and Sensor 2/Stream 2 individually.

(Refer to ■ **Set imaging conditions for each image sensor individually.**)

Pixel format

This camera can capture three images simultaneously.

Videos in Sensor 0/Stream 0, Sensor 1/Stream 1 and Sensor 2/Stream 2 can be output as a triple stream.

The selectable PixelFormat, Sensor 0/Stream 0, Sensor 1/Stream 1 and Sensor 2/Stream 2 all differ depending on the type of image sensor selected.

Supported PixelFormat :

Bayer color (BayerRG8, BayerRG10, BayerRG12, BayerRG10Packed,
BayerRG12Packed)

monochrome (Mono8, Mono10, Mono10Packed, Mono12, Mono12Packed)

The fastest frame rate can be realized by BayerRG8 or Mono8, which has the smallest number of bits per pixel.

Note

Sensor 0/Stream 0, Sensor 1/Stream 1 and Sensor 2/Stream 2 are three UDP streams, each assigned a different port number. The assigned port number can be confirmed with the following settings.

In [TransportLayerControl] - [GevStreamChannelSelector], select the stream whose port number you want to check, the port number will be displayed in [GevSCSP].

*) The port number for Stream 0 is automatically assigned from eBUS Player for JAI, but Stream 1 and Stream 2 must be set by the user.

Refer to "Three stream transmission", "Display video in the near-infrared region" and "Simultaneous transmission/display of all three streams" for details.

VideoProcessBypassMode

The video process bypass mode is a function that bypasses internal video processing on the camera. When bypass is enabled, the sensor output and camera output data can be set to the same bit width.

12-bit outputs can only be performed in bypass mode.

■ Functions available in VideoProcessBypassMode

The following functions can be used in video process bypass mode.

Gain[AnalogAll], AutoGain, BlemishCompensation, BinningVertical

■ PixelFormat available in VideoProcessBypassMode Only

Bayer color (BayerRG12, BayerRG12Packed)

Monochrome (Mono12, Mono12Packed)

Bandwidth of three streams

This camera can capture three images simultaneously.

Video in Sensor 0/Stream 0, Sensor 1/Stream 1 and Sensor 2/Stream 2 can be output as a triple stream.

For synchronous free-running operation of all three streams, the bandwidth assigned to Sensor 0/Stream 0, Sensor 1/Stream 1 and Sensor 2/Stream 2 is determined as follows: (This ratio cannot be changed.)

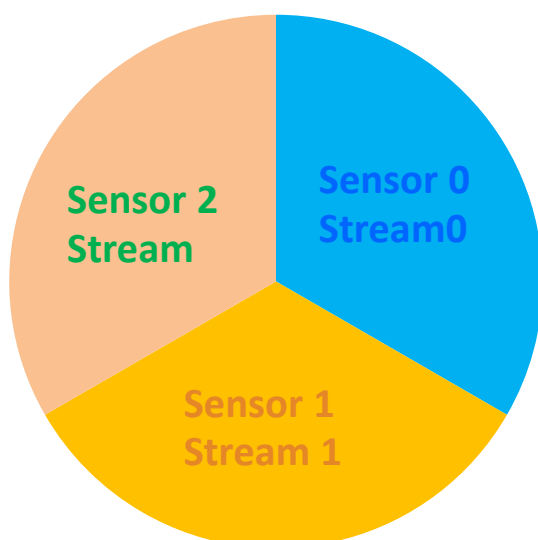

Acquisition Control

This camera has three Acquisition modes (SingleFrame, MultiFrame, Continuous). Use [AcquisitionControl] settings to perform operations and settings for image capture.

SingleFrame

When the [AcquisitionStart] command is executed, one frame of image is captured.



MultiFrame

When the [AcquisitionStart] command is executed, the number of frames set in [AcquisitionFrameCount] are acquired as images.

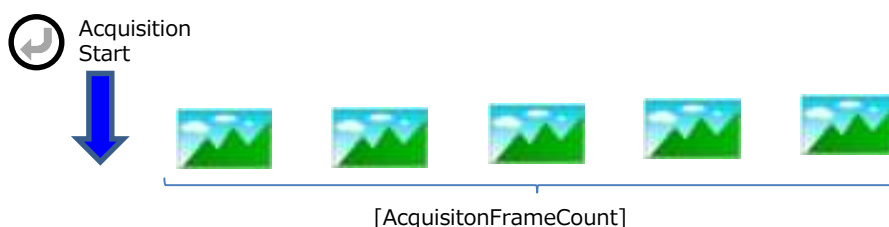

Continuous

When the [AcquisitionStart] command is executed, images will continue to be acquired until the [AcquisitionStop] command is executed.



Changing the Frame Rate

When [TriggerMode] is disabled, you can change the frame rate in [AcquisitionFrameRate].

Note

- The shortest frame period varies depending on the ROI, pixel format, and binning mode selected. The longest frame period is 0.125 Hz (8 sec.).
- When TriggerMode[FrameStart] is enabled, the [AcquisitionFrameRate] setting is disabled.

Exposure Mode

This camera has three Exposure modes (Off, Timed, TriggerWidth). Use [AcquisitionControl] settings to perform operations and settings for exposure.

ExposureMode = Off

Exposure control is not performed (free-running operation). The exposure time is the longest possible time within the operating conditions such as the frame rate.

ExposureMode = Timed

Mode in which control is performed using exposure time. Acquire images using an exposure time configured beforehand on an external trigger. In this mode, the exposure time can be adjusted automatically by setting [ExposureAuto]. For details, refer to "ALC (Automatic Brightness Control) Function".

ExposureMode = TriggerWidth

Mode in which control of the exposure time is performed using the pulse width of the trigger input signal. The exposure time will be the same as the pulse width of the trigger input signal.

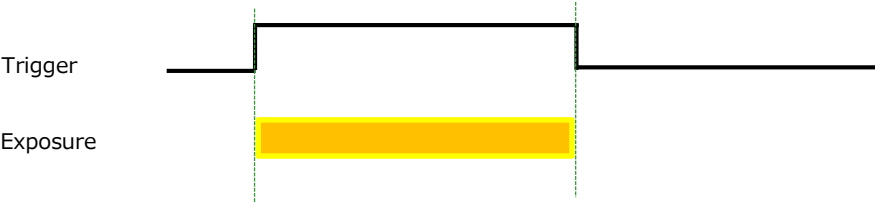

The diagram shows two horizontal axes. The top axis is labeled 'Trigger' and shows a pulse that rises from a low level to a high level and then falls back to low. The bottom axis is labeled 'Exposure' and shows a yellow rectangular bar. Vertical dashed lines indicate that the start and end of the yellow bar align perfectly with the start and end of the trigger pulse.

- The settings for exposure control and triggers are related to each other. Be sure to configure the settings described in "Trigger Control".
- Configurable combinations of [ExposureMode], [ExposureModeOption] and [FrameStartTrigger]. Among all combinations of the following three settings, white is the combination that can be set.

ExposureMode	ExposureModeOption	FrameStartTrigger
Off	Off	Off
		On
	RCT	Off
		On
Timed	Off	Off
		On
	RCT	Off
		On
TriggerWidth	Off	Off
		On
	RCT	Off
		On

Actual Exposure Times

The shortest exposure times that can be configured are as follows.

ExposureMode	Shortest exposure time
Timed	14.73us (8bit)
TriggerWidth	14.73us (8bit)

- The actual exposure time will consist of the image sensor's offset duration (13.73 μ s) added to the setting configured on the camera.
- When [ExposureMode] is set to [Timed] and the exposure time is set to 1 μ s, the actual exposure time will be as follows.
1 μ s + 13.73 μ s (offset duration of image sensor) = 14.73 μ s
- When [ExposureMode] is set to [TriggerWidth], the exposure is slightly longer than the width of the trigger signal. To achieve an exposure time of 14.73 μ s and the exposure time offset is 13.73 μ s, use 14.73 μ s - 13.73 μ s = 1 μ s as the high or low time for the trigger signal.

Trigger Control

The camera allows the following controls to be performed via external trigger signals.

TriggerSelector	Description
AcquisitionStart	Start image acquisition in response to the external trigger signal input.
AcquisitionEnd	Stop image acquisition in response to the external trigger signal input.
FrameStart	Start exposure in response to the external trigger signal input. Select this to perform exposure control using external triggers.
FrameTransferStart	Output acquired images at a specified timing in response to an external trigger signal input.

- The settings for exposure control and triggers are related to each other. Be sure to configure the settings described in “ExposureMode” .
- You can delay when exposure actually starts after a trigger is received by a specific amount of time by configuring [TriggerDelay].

Select the trigger type with TriggerSelector, and set the following items for each trigger.

[TriggerMode] Switch enable or disable.

[TriggerSource] Select the source signal.

PulseGenerator0, PulseGenerator1, PulseGenerator2, PulseGenerator3,
UserOutput0, UserOutput1, UserOutput2, UserOutput3,
Action0, Action1, Action2, Action3,
Software*,
Line4, Line5, Line6, Line10,
Nand0Out, Nand1Out

* Trigger can be executed by TriggerSoftware [TriggerSelector] command only when Software is set.

[TriggerActivation] Sets the polarity of the trigger signal.

[TriggerDelay] You can specify a delay after receiving the trigger signal until the trigger is enabled.

The source signals that can be set for the trigger are as follows.

	Off	AcquisitionActive	FrameActive	ExposureActive	FVAL	LVAL	Action3	Action2	Action1	Action0	Software	PulseGenerator0	PulseGenerator1	PulseGenerator2	PulseGenerator3	UserOutput0	UserOutput1	UserOutput2	UserOutput3	Line4	Line5	Line6	Line10	Nand0Out	Nand1Out	Low	High	AcquisitionTriggerWait	FrameTriggerWait
AcquisitionStart							✓	✓	✓	✓	✓	✓	✓	✓	✓	✓	✓	✓	✓	✓	✓	✓	✓	✓	✓	✓			
AcquisitionEnd							✓	✓	✓	✓	✓	✓	✓	✓	✓	✓	✓	✓	✓	✓	✓	✓	✓	✓	✓	✓			
FrameStart							✓	✓	✓	✓	✓	✓	✓	✓	✓	✓	✓	✓	✓	✓	✓	✓	✓	✓	✓	✓			
AcquisitionTransferStart							✓	✓	✓	✓	✓	✓	✓	✓	✓	✓	✓	✓	✓	✓	✓	✓	✓	✓	✓	✓			

When using FrameStart trigger

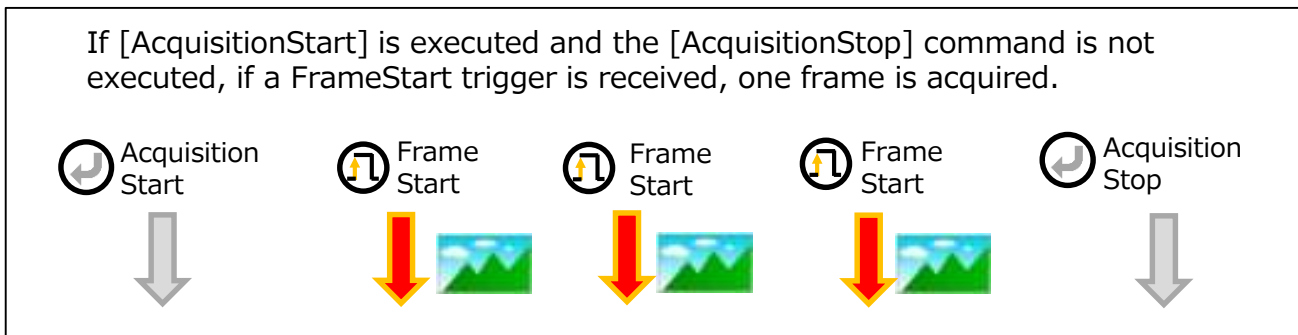

invalid	invalid	valid	invalid
AcquisitionStart	AcquisitionEnd	FrameStart	AcquisitionTransferStart
TriggerMode off	TriggerMode off	TriggerMode On	TriggerMode off
TriggerSoftware	TriggerSoftware	TriggerSoftware	TriggerSoftware
TriggerSource	TriggerSource	TriggerSource	TriggerSource
TriggerActivation	TriggerActivation	TriggerActivation	TriggerActivation
TriggerOverlap	TriggerOverlap	TriggerOverlap	TriggerOverlap
TriggerDelay	TriggerDelay	TriggerDelay	TriggerDelay

When using FrameStartTrigger, select FrameStart in [TriggerSelector], enable [TriggerMode], and set the source signal in [TriggerSource]. Also, set [TriggerSource], [TriggerActivation], [TriggerOverlap], and [TriggerDelay] as necessary.

For triggers that are not used (AcquisitionStart, AcquisitionEnd, AcquisitionTransferStart), disable each [TriggerMode].

GPIO (Digital Input/Output Setting)

The unit can input/output the following signals to and from external input/output connectors.

External Output	Line1: TTL Out 1	DC IN / TRIG IN connector (12-pin round)
	Line2: Opto Out 1	DC IN / TRIG IN connector (12-pin round)
	Line3: Opto Out 2	AUX connector (10-pin)
	Line8: TTL Out 2	AUX connector (10-pin)
External Input	Line4: TTL In 1	DC IN / TRIG IN connector (12-pin round)
	Line5: Opto In 1	DC IN / TRIG IN connector (12-pin round)
	Line6: Opto In 2	DC IN / TRIG IN connector (12-pin round)
	Line10: TTL In 2	AUX connector (10-pin)

These signals can be used as triggers and other necessary signals within the camera or as signals output from the camera to the system, such as those used for lighting equipment control.

Use the [Digital I/O Control] to set the digital input / output.

Select input or output in [LineSelector], you can check [LineMode], [LineFormat] and set [LineInverter].

You can also check the status of each digital I/O as shown in the table below with [LineStatusAll].

	LineMode	LineFormat	LineInverter	LineStatusAll
Line1	Output	TTL	True/False	bit0
Line2	Output	OptoCoupled	True/False	bit1
Line3	Output	OptoCoupled	True/False	bit2
Line4	Input	TTL	False (fixed)	bit3
Line5	Input	OptoCoupled	False (fixed)	bit4
Line6	Input	OptoCoupled	False (fixed)	bit5
Line8	Output	TTL	True/False	bit7
Line10	Input	TTL	False (fixed)	bit9
Nand0In1	Input	InternalSignal	True/False	
Nand0In2	Input	InternalSignal	True/False	
Nand1In1	Input	InternalSignal	True/False	
Nand1In2	Input	InternalSignal	True/False	
TimestampReset	Internal Connection	InternalSignal	False (fixed)	

The following figure shows the relationship between the trigger signal and exposure for the source signal that can be set as LineSource.

FrameTriggerWait	Valid while waiting for Frame Start trigger.
AcquisitionTriggerWait	Valid while waiting for Acquisition start trigger.
ExposureActive	Valid while exposed.
FrameActive	Valid when acquiring one frame of image.
AcquisitionActive	Valid when acquisition is enabled.
High	Always valid regardless of camera status.
Low	Always invalid regardless of camera status.

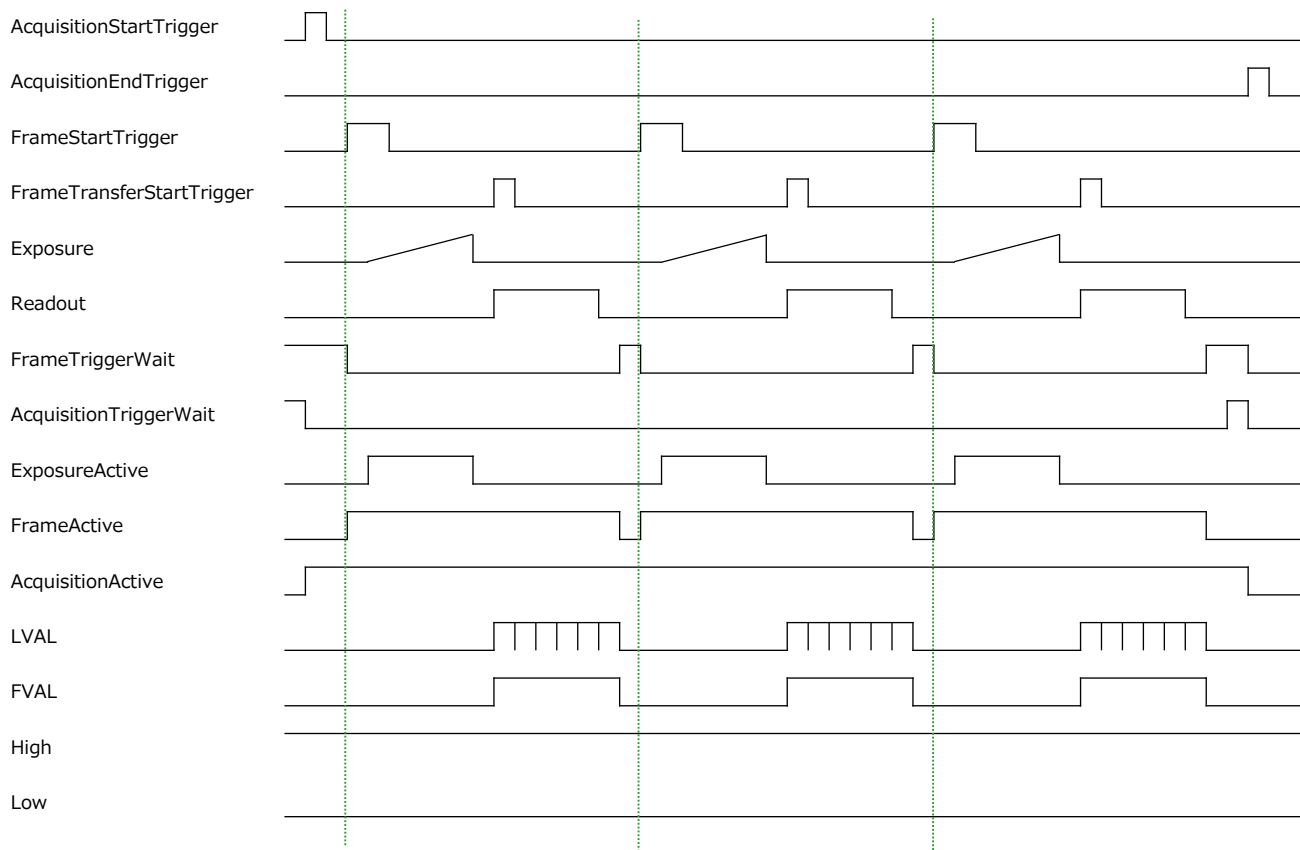

Use case (1)

Sensor 0/Stream 0 works at the maximum frame rate in free run mode.
 Sensor 1/Stream 1 uses an external trigger with an interval of 100 msec and images at a low frame rate.
 How to set up this use case is explained below.



1. Select acquisition asynchronous mode, because acquisition timing is different.
 - a. Select "AsyncMode" in [AcquisitionControl]->[AcquisitionSyncMode].
2. Sensor 0/Stream 0 setting
 - a. Select "Source 0" in [SourceControl]->[SourceSelector].
 - b. [AcquisitionControl]->
 - Set TriggerMode[AcquisitionStart] to Off.
 - Set TriggerMode[AcquisitionEnd] to Off.
 - Set TriggerMode[FrameStart] to Off.
 - Set TriggerMode[AcquisitionTransferStart] to Off.
 - c. Set [AcquisitionControl]->[ExposureMode] to Off.
 - d. Select "Mono8" or "BayerRG8" in [ImageFormatControl]->[PixelFormat].
3. Sensor 1/Stream 1 setting
 - a. Select "Source 1" in [SourceControl]->[SourceSelector].
 - b. [AcquisitionControl]->
 - Set TriggerMode[FrameStart] to On.
 - Select "Line4" in TriggerSource[FrameStart].
 - c. Select "Mono8" or "BayerRG8" in [ImageFormatControl]->[PixelFormat].
3. Sensor 1/Stream 1 setting
 - a. Select "Source 1" in [SourceControl]->[SourceSelector].
 - b. [AcquisitionControl]->
 - Set TriggerMode[FrameStart] to On.
 - Select "Line4" in TriggerSource[FrameStart].
 - c. Select "Mono8" or "BayerRG8" in [ImageFormatControl]->[PixelFormat].

■ Framerate

In this use case, 33% of 10 Gbps (3.3 Gbps) are allocated to Sensor 0/Stream 0. Depending on the Exposure setting, the frame rate of Sensor 0/Stream 0 can be read at a maximum speed of 107.2 fps.
 Sensor 1/Stream 1 and Sensor 2/Stream 2 have a frame rate of 10 fps because the FrameStart trigger time interval is 100 ms.
 (It is possible to speed up to 107.2 fps by shortening the FrameStart trigger time interval.)

Use case (2)

Synchronize and capture sensor 0/stream 0, sensor 1/stream 1 and Sensor 2/Stream 2
How to set up this use case is explained below.

Sensor 0/Stream 0

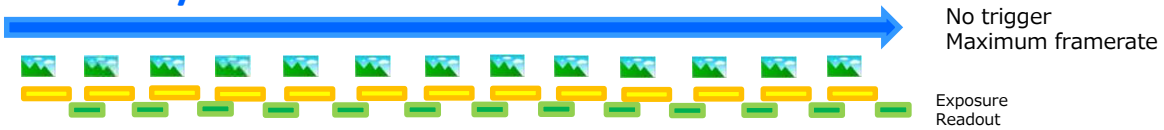

Sensor 1/Stream 1



Sensor 2/Stream 2



1. Select Acquisition synchronization mode, because it operates with the same imaging timing.
 - a. Select "SyncMode" in [AcquisitionControl]->[AcquisitionSyncMode].
2. Sensor 0/Stream 0 setting
 - a. Select "Source 0" in [SourceControl]->[SourceSelector].
 - b. [AcquisitionControl]->
 - Set TriggerMode[AcquisitionStart] to Off.
 - TriggerMode[AcquisitionEnd] to Off.
 - TriggerMode[FrameStart] to Off.
 - TriggerMode[AcquisitionTransferStart] to Off.
 - c. [AcquisitionControl]->[ExposureMode] to Off.
 - d. Select "Mono8" or "BayerRG8" in [ImageFormatControl]->[PixelFormat].
3. Sensor 1/Stream 1 setting
 - a. Select "Source 1" in [SourceControl]->[SourceSelector].
 - b. Set [AcquisitionControl]->[ExposureMode] to Off.
 - c. Select "Mono8" or "BayerRG8" in [ImageFormatControl]->[PixelFormat].
4. Sensor 2/Stream 2 setting
 - a. Select "Source 2" in [SourceControl]->[SourceSelector].
 - b. Set [AcquisitionControl]->[ExposureMode] to Off.
 - c. Select "Mono8" or "BayerRG8" in [ImageFormatControl]->[PixelFormat].

■ Framerate

In this use case, 33% of 10 Gbps (3.3 Gbps) are allocated to Sensor 0/Stream 0. Depending on the Exposure setting, the frame rate of Sensor 0/Stream 0 can be read at a maximum speed of 107.2 fps.

33% of 10 Gbps (3.3 Gbps) are allocated to Sensor 1/Stream 1 and Sensor 2/Stream 2.

Depending on the Exposure setting, the frame rate of Sensor 1/Stream 1 and Sensor 2/Stream 2 can be as high as 107.2 fps at a high speed, as with Sensor 0/Stream 0.

Basic Function Matrix

The combinations of settings for the basic functions that can be used together are as follows.

ExposureMode	FrameStartTrigger	ExposureTime	ROI	BalanceWhiteAuto	GainAuto	ExposureAuto	Sequencer	
							TriggerSequencerMode	CommandSequencerMode
Off	Off	x	○	○	○	x	x	x
Timed	Off	○	○	○	○	○	x	○
Timed(EPS)	On	○	○	○	○	○	○	○
TriggerWidth	On	x	○	○	○	x	x	x
RCT	On	○	○	○	○	○	x	x

Calculate the maximum frame rate (approximate)

H_Period

Use the foillowing formula to calculate H_Period for Sensor 0/Stream 0, Sensor 1/Stream 1, and Sensor 2/Stream 2.

$$H_Period = \text{MAX}(\text{Sensor_H_Period}, \text{Interface_H_Period}, \text{FPGA_H_Period})$$

Among Sensor_H_Period, Interface_H_Period, and FPGA_H_Period, the one with the largest value is H_Period.

■ Sensor_H_Period

Sensor_H_Period is a fixed value for each PixelFormat regardless of the ROI size. Please refer to the table below.

PixelFormat	PixelSize	Sensor_H_Period(μs)
BayerRG8	8	5.1179
BayerRG10	16	5.9798
BayerRG12	16	5.9798
BayerRG10Packed	12	5.9798
BayerRG12Packed	12	5.9798
Mono8	8	5.1179
Mono10	16	5.9798
Mono12	16	5.9798
Mono10Packed	12	5.9798
Mono12Packed	12	5.9798

■ Interface_H_Period

Calculate the Interface_H_Period using the following formulas.

$$\text{Interface_H_Period} = (\text{Width} \times \text{PixelSize}) / (\text{AvailablePayloadBandwidth} \times 1000)$$

Refer to the values in the table above for PixelSize.

[When the maximum packet length is 1472 bytes and the packet delay is 0 ns]

LinkSpeed	AvailablePayloadBandwidth
10Gbps	2.7859
5Gbps	1.463
2.5Gbps	0.7235
1Gbps	0.2984

[When the maximum packet length is 8976 bytes and the packet delay is 0 ns]

LinkSpeed	AvailablePayloadBandwidth
10Gbps	2.9086
5Gbps	1.5106
2.5Gbps	0.7429
1Gbps	0.3053

Caution

The value of AvailablePayloadBandwidth varies depending on conditions such as maximum packet length and packet delay.

■ FPGA_H_Period

Calculate the FPGA_H_Period using the following formulas.

$$\text{FPGA_H_Period} = (\text{Width} + 8) \div 4 + 32 \div 111$$

Maximum frame rate period formula

Calculate H_Period (number of clocks) from H_Period.

$$\text{H_Period(number of clocks)} = \text{ROUNDUP}(\text{H_Period} \times 74.25, 0)$$

Maximum frame rate

$$= 74.25 \times 1000000 \div (\text{H_Period(number of clocks)} \times (\text{Height} + 48))$$

- [ExposureMode] = [Timed]
 - [ExposureModeOption] = [Off]

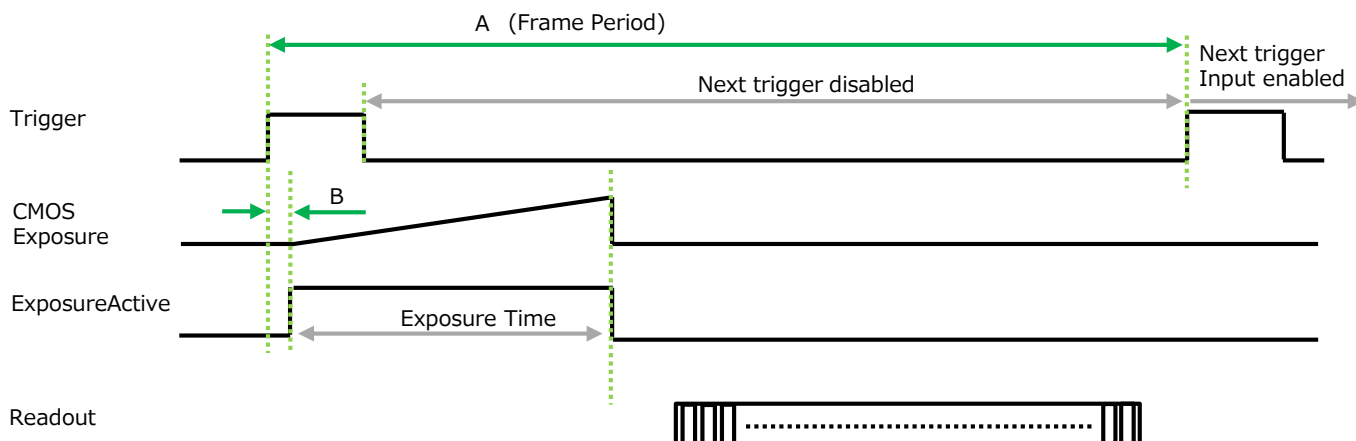

PixelFormat	Frame Period [A] (usec)	Period From Trigger start edge to Exposure start [B] (usec)
Binning Off		
Mono8	9323	18.5
Mono10Packed Mono12Packed	13975	27.3
Mono10 Mono12	18646	36.1
BayerRG8	9323	17.8
BayerRG10Packed BayerRG12Packed	13975	26.3
BayerRG10 BayerRG12	18646	34.7
Horizontal Binning On		
Mono8	8107	16.2
Mono10Packed	9472	18.8
Mono10	9472	18.8
Vertical Binning On		
Mono8	4780	18.5
Mono10Packed Mono12Packed	7164	27.3
Mono10 Mono12	9559	36.1

■ [ExposureMode] = [Timed]

- [ExposureModeOption] = [RCT]

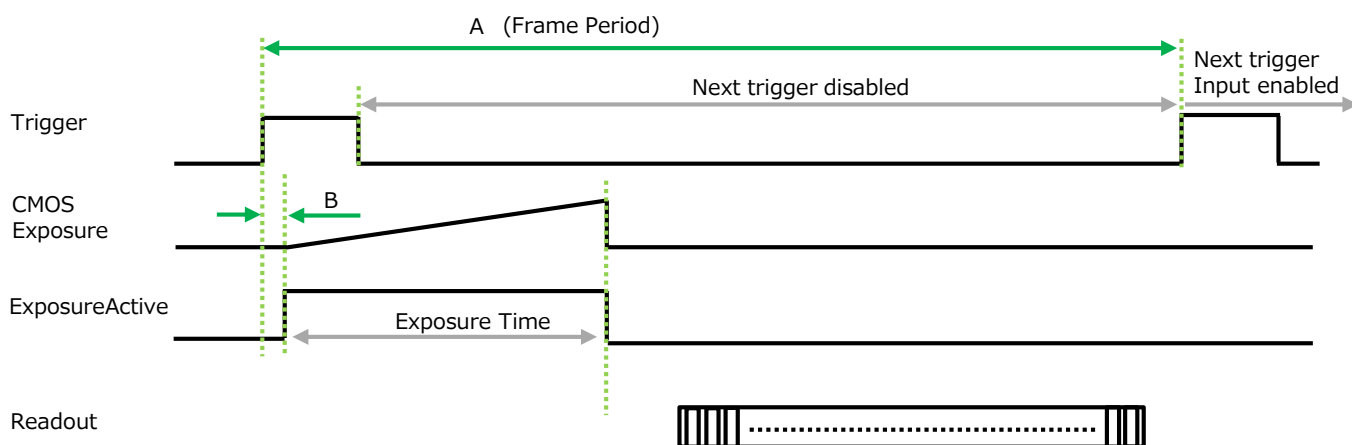

PixelFormat	Frame Period [A] (usec)	Period From Trigger start edge to Exposure start [B] (usec)
Binning Off		
Mono8	100100	113.7
Mono10Packed Mono12Packed	100150	177.3
Mono10 Mono12	100200	236.3
BayerRG8	100100	118.5
BayerRG10Packed BayerRG12Packed	100150	170
BayerRG10 BayerRG12	100200	226.3
Horizontal Binning On		
Mono8	100096	103.2
Mono10Packed	100096	120.4
Mono10	100103	120.4
Vertical Binning On		
Mono8	100102	118.5
Mono10Packed Mono12Packed	100205	177.3
Mono10 Mono12	100203	236.3

■ [ExposureMode] = [TriggerWidth]

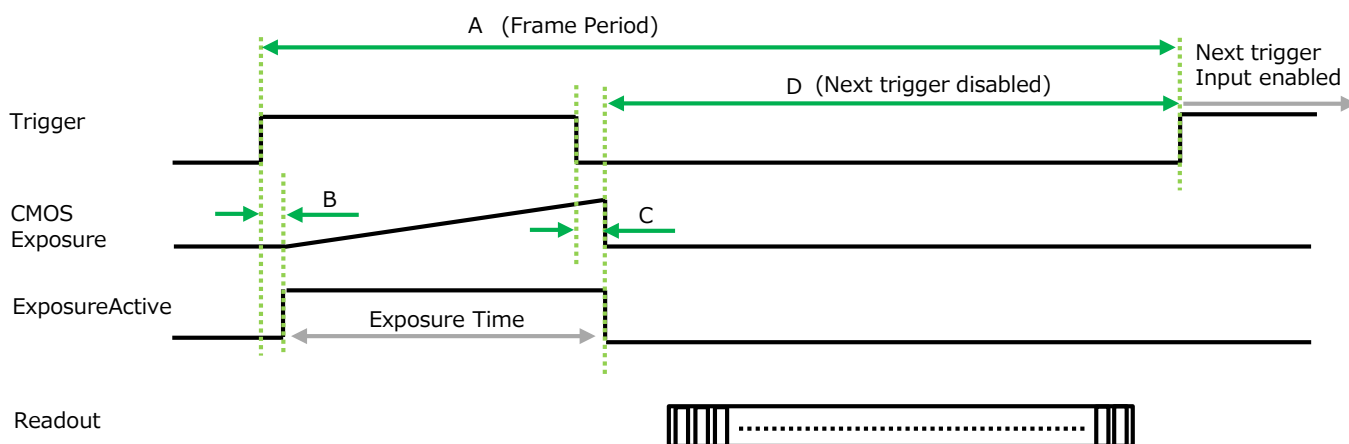

PixelFormat	Frame Period [A] (usec)	Period From Trigger start edge to Exposure start [B] (usec)	Period From Trigger end to Exposure end [C] (usec)	Period From Exposure end to next Trigger Start [D] (usec)
Binning Off				
Mono8	9300	18.5	18.5	71
Mono10Packed Mono12Packed	13939	27.3	27.3	107
Mono10 Mono12	18600	36.1	36.1	142
BayerRG8	9300	17.7	17.7	68
BayerRG10Packed BayerRG12Packed	13939	26.3	26.3	101
BayerRG10 BayerRG12	18600	34.7	34.7	135
Horizontal Binning On				
Mono8	8087	16.1	16.1	62
Mono10Packed	9450	18.8	18.8	72
Mono10	9449	18.8	18.8	72
Vertical Binning On				
Mono8	4757	18.5	18.5	71
Mono10Packed Mono12Packed	7129	27.3	27.3	107
Mono10 Mono12	9512	36.1	36.1	142

Gain Control

Bayer color

Adjust the [AnalogAll] (master gain) setting first, and then adjust the [AnalogRed], [DigitalRed], [AnalogBlue], and [DigitalBlue] setting values to perform fine adjustment.

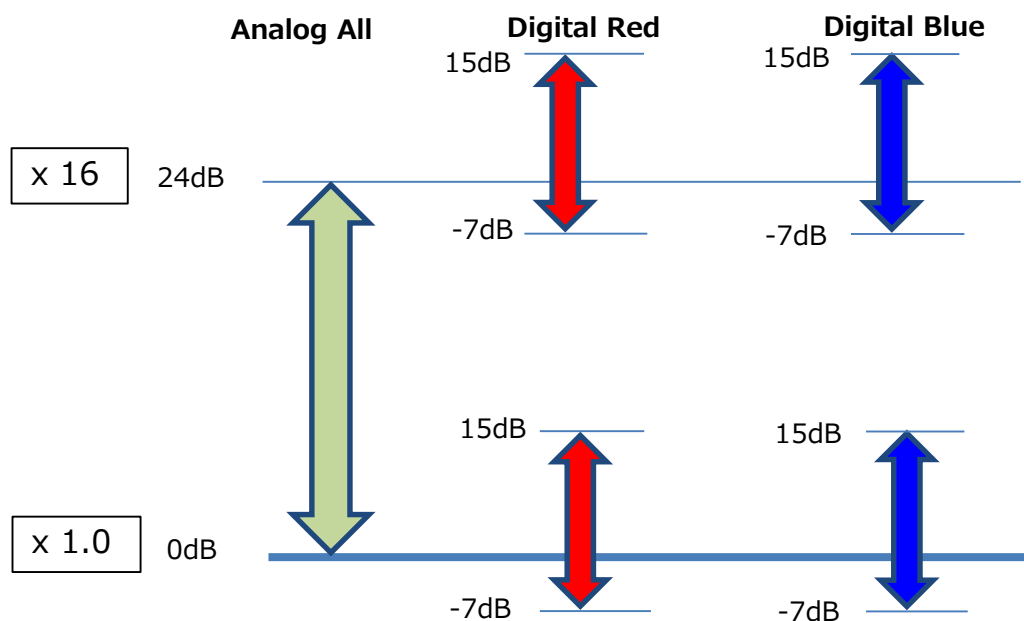

Monochrome

Adjust the [AnalogAll] (master gain) setting.

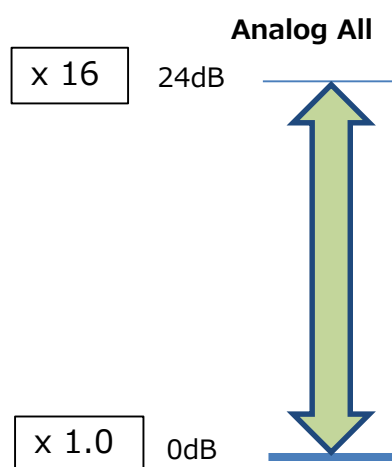

■ Automatic Gain Level Control

Set [GainAuto] to [Continuous] to control the gain level automatically.

When [GainAuto] is set to [Continuous], you can configure the conditions for automatic adjustment in detail.

When [GainAuto] is set to [Continuous], automatic adjustment will be performed continuously.

When [GainAuto] is set to [Once], automatic adjustment will be performed only once.

ALC (Automatic Level Control) Function

The ALC (automatic level control) function combines the automatic gain control (AGC/Auto Gain Control) and automatic exposure control (ASC/Auto Shutter Control) functions, and is capable of handling various changes in brightness. The function operates as follows in response to changes in brightness.

Change from bright to dark: ASC → AGC

Change from dark to bright: AGC → ASC

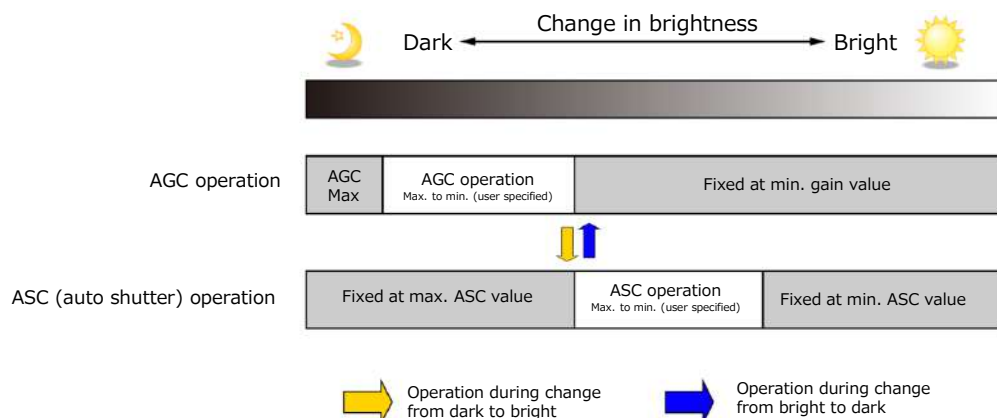

■ To use the ALC function

Set [GainAuto] or [ExposureAuto] or both to [Continuous] mode. Configure the minimum value, maximum value, etc. for AGC and ASC under [JAICustomControlALC].

The target video levels for AGC and ASC are configured in [ALCReference].

For example, when [ALCReference] is set to 95%, video levels will be maintained at 95% for AGC and ASC.

Gamma Function

The gamma function corrects the output signals from the camera beforehand (reverse correction), taking into consideration the light-emitting properties of the monitor display. As the light-emitting properties of the monitor are not linear, the entire image may be darker or the gradation in the dark areas may be less noticeable when camera outputs are displayed without processing.

The gamma function can be used to correct the camera signals with an opposite-direction curve and produce a display that is close to linear.

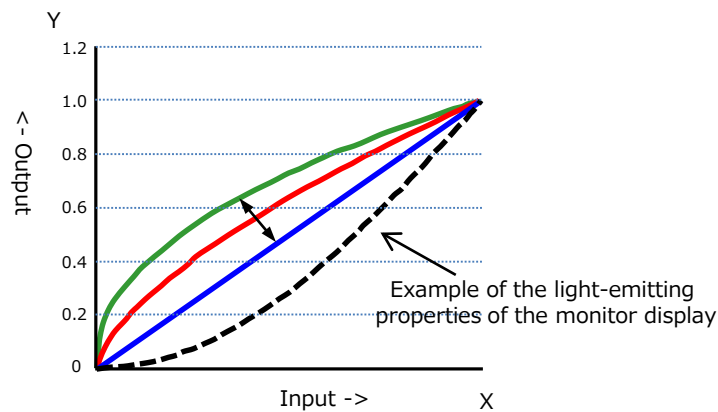

■ To use the gamma function

Configure the settings as follows.

Item	Setting value / selectable range	Description
Gamma	0.45, 0.5, 0.55, 0.6, 0.65, 0.75, 0.8, 0.9, 1.0	Select the gamma correction value.
LUTMode	Gamma	Use gamma.

Note

You can use the LUT function to configure a curve with more detailed points. For details, see "Lookup Table (LUT)".

Lookup Table (LUT)

The LUT function is used to generate a non-linear mapping between signal values captured on the sensor and those that are output from the camera. You can specify the output curve using 257 setting points (indexes).

■ To use the LUT function

Configure the settings as follows.

Item	Setting value / selectable range	Description
LUTMode	LUT	Use LUT.
LUTSelector*	Red, Green, Blue	Select the LUT channel to control.
LUTIndex	0 ~ 256	Select the LUT index to configure. Indexes represent the possible pixel values captured on the sensor, from the lowest value (Index 0) to the highest (Index 256). For example, Index 0 represents a full black pixel and Index 256 represents a full white pixel.
LUTValue	0 ~ 4095	Set the LUT output value for the selected index.

*) Sensor 0/Stream 0 only

■ LUT values

LUT values range from 0 at the lowest to 4095 at the highest. Linear interpolation is used to calculate LUT values between the index points.

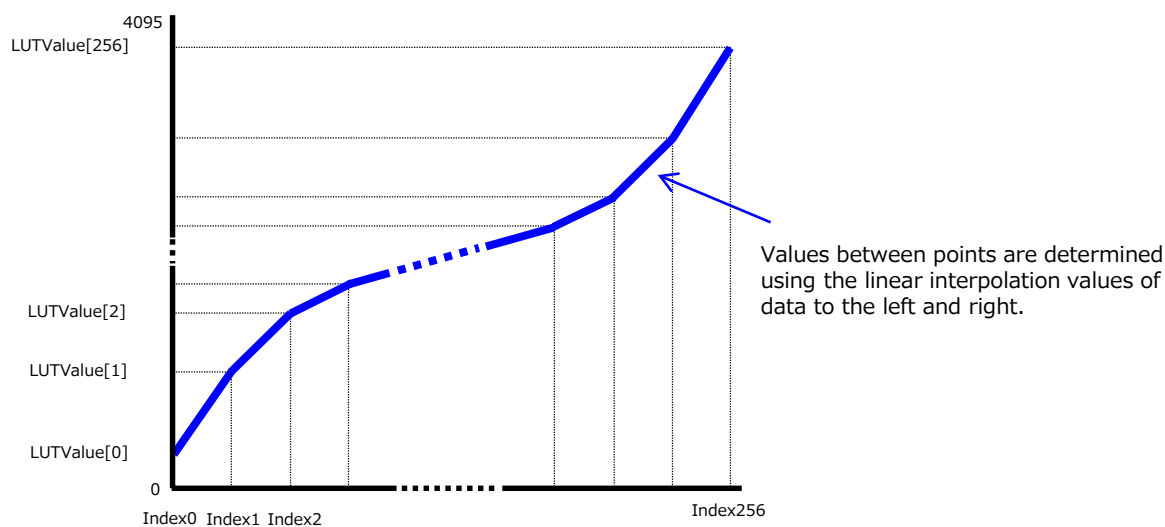

BlemishCompensation

Multiple defective pixels that are not adjacent to each other can occur on conventional CMOS sensor cameras.

This camera features a function that interpolates defective pixels using the surrounding pixels. Up to 1736 pixels can be corrected for each of the three sensors. Pixel interpolation can be performed via automatic detection or point-by-point manual settings.

■ Automatic detection

Automatic detection can only detect lit defective pixels (i.e., white blemishes).

1 Shield the camera sensor.

If a lens is attached, use the lens cap as a shield, for example.

2 Configure the threshold level for defective pixel detection.

Up to 1736 pixels can be corrected. The threshold value is specified as a percentage. The default setting is "10" with 10% of the full scale (100%) specified as the threshold value.

3 Execute [BlemishDetect] to start automatic detection.

After detection, the interpolation data is saved to the camera's internal memory.

To check the number of interpolated pixels after automatic detection

You can check the number of pixels interpolated via automatic detection by loading the BlemishNum data.

■ Manual configuration

1 Select the index in [BlemishCompensationIndex].

You can select from 1 to 1736. However, configure the indexes in order starting with the smallest index. If you skip indexes while configuring settings, interpolation may not be performed.

2 Specify the pixel points for interpolation using the [BlemishCompensationPositionX] and [BlemishCompensationPositionY] settings.

You can configure values that are within the total effective pixel area. Specify pixels for which interpolation is not necessary as -1. If 0 is specified, the first line or first pixel will be interpolated.

3 Execute [BlemishStore].

Blemish compensation data will be stored.

4 Set [BlemishEnable] to [True], and execute interpolation.

If it is set to [False] , Blemish compensation is not effective.

ShadingCorrection

The ShadingCorrection function corrects non-uniformity (i.e., shading) in the amount of light generated by the lens and lighting equipment. Using this function allows correction even if top, bottom, left, and right shading is not symmetrical in relation to the center of the screen (H, V).

This function can be used even when the effective image area is limited (an area with both Width and Height set to more than 128 must be configured) by the ROI function. In such cases, the correction area is included in the image area configured by the ROI.

For a full image, the number of correction blocks is 16 (H) × 12 (V) blocks and calculation errors in the correction data are minimized due to the small interpolation areas. Each block is 128 × 128 pixels. The total size of the blocks is 2048 (H) × 1536 (V), the actual number of effective pixels for the camera is same.

When using ROI, the number of blocks and the number of pixels that comprise each block differ from a full image.

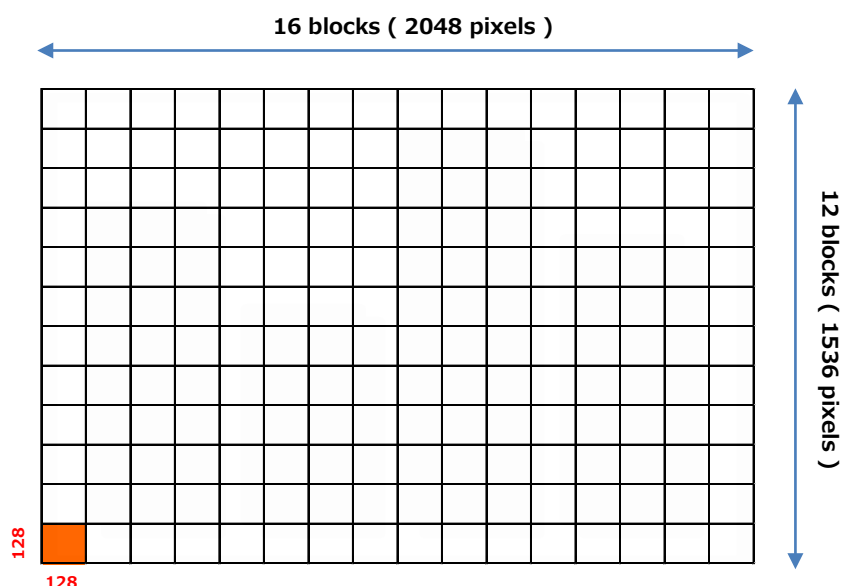

The following shading correction modes are available on the camera.

■ FlatShading

Correction is performed using the area of the screen with the highest brightness level as the reference, and adjusting the brightness levels of the other areas to match this level.

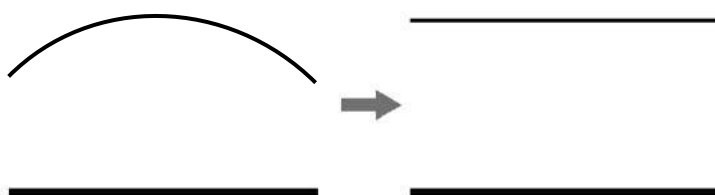

■ ColorShading (bayer color only)

R-channel and B-channel properties are adjusted to using the G-channel shading properties as a reference.

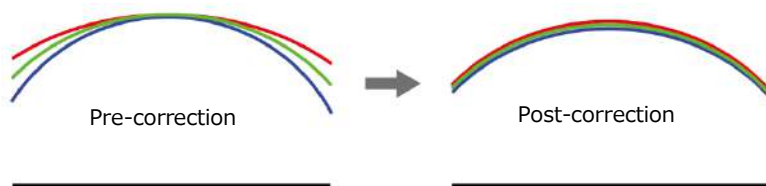

Caution

- For FlatShading and ColorShading, the maximum amount of correction gain for all pixels is limited to 8 times the amount of gain before correction. (The amount of gain cannot be increased to more than 8 times the amount of gain from before correction.)
- If the area in the screen with the highest brightness level is 175 LSB or less (during 10-bit video output), proper correction is not possible.

■ To use the shading correction function

Configure the settings as follows.

Item	Setting value	Description
ShadingCorrectionMode	FlatShading, ColorShading	Select the shading correction mode.
ShadingMode	User1, User2, User3, Off	Select the user area to which to save the shading correction value.

Display a white chart under a uniform light, and execute [PerformShadingCalibration].

Note

After shading correction is executed, the shading correction value is automatically saved to the user area selected in [ShadingMode].

Binning Function

(Monochrome only)

The binning function allows you to combine the signal values of clusters of adjacent pixels to create improved virtual pixels. Using the function results in images with lower pixel resolution and higher sensitivity.

Horizontal Binning performs addition or averaging digitally.
Vertical Binning performs addition within the image sensor.

ROI (Regional Scanning Function)

The ROI (region of interest) function allows you to output images by specifying the areas to scan.

Specify the area to scan by specifying width, height, and horizontal/vertical offset values under [ImageFormatControl].

For details on how to configure the settings, see "Configuring the Output Format".

You can increase the frame rate by specifying a lower height, as the number of lines scanned decreases. The setting ranges for the ROI function's readable area based on the Binning setting (BinningHorizontal, BinningVertical) are as follows.

Width (pixels)	Height (lines)
BinningHorizontal Off: 16 to 2048 step 16	BinningVertical Off: 8 to 1536 step 4
BinningHorizontal On: 8 to 1024 step 8	BinningVertical On: 8 to 768 step 2

Offset X (pixels)	Offset Y (lines)
BinningHorizontal Off: 0 to 2032 step 16	BinningVertical Off: 0 to 1528 step 4
BinningHorizontal On: 0 to 1016 step 8	BinningVertical On: 0 to 760 step 2

Binning Function is available in Sensor 1/Stream 1 and Sensor 2/Stream 2 only.

Example 1) Without Binning

[BinningHorizontal]
[BinningVertical]

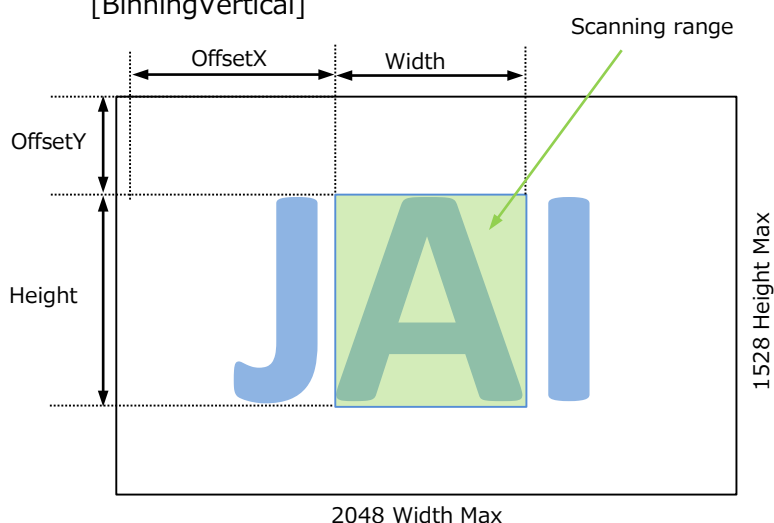

Example 2) With Binning

[BinningHorizontal]
[BinningVertical]

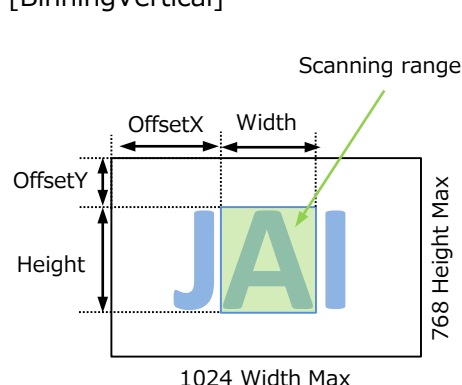

Multi ROI

In the Multi ROI mode, you can specify up to 64 scanning areas for a single-frame image. The areas cannot overlap.

The Multi ROI mode can be used only when both the Sequencer mode and the Shading mode are off.

You can set different areas separately for Sensor 0/Stream 0, Sensor 1/Stream 1, and Sensor 2/Stream 2, regardless of the acquisition mode used.

Set [MultiROIControl]->[MultiRoiMode] On. Select from the eight indexes in [MultiRoiIndex] then set [MultiRoiWidth], [MultiRoiHeight], [MultiRoiOffsetX] and [MultiRoiOffsetY].

And set the maximum index number to be enabled to [MultiRoiVerticalEnableNumber] and [MultiRoiHorizontalEnableNumber].

■ Example

To use six areas as shown below, refer to the following.

1. Set [MultiROIControl]->[MultiRoiMode] On.
2. Select "0" in [MultiRoiIndex].
Set [MultiRoiWidth], [MultiRoiHeight], [MultiRoiOffsetX] and [MultiRoiOffsetY].
3. Select "1" in [MultiRoiIndex].
Set [MultiRoiWidth], [MultiRoiHeight], [MultiRoiOffsetX] and [MultiRoiOffsetY].
4. Select "2" in [MultiRoiIndex].
Set [MultiRoiWidth] and [MultiRoiOffsetX].
5. Set 2 to [MultiRoiVerticalEnableNumber].
6. Set 3 to [MultiRoiHorizontalEnableNumber].

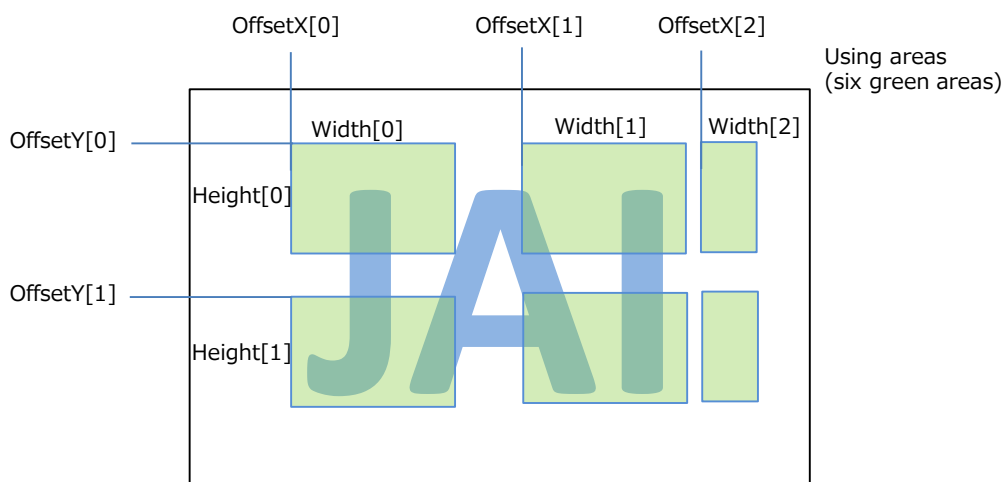

Output image

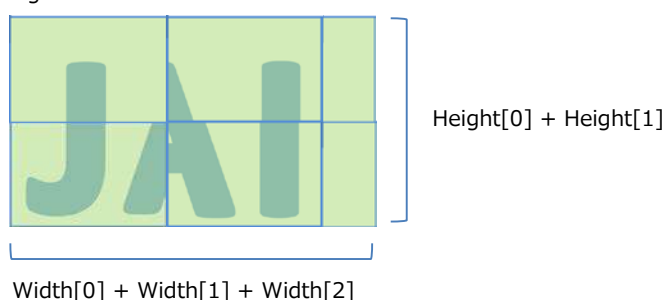

Sequencer Function

The Sequencer function lets you define up to 128 index combinations of exposure time, gain, ROI, and other settings which can be stepped through each time a trigger is received. This is particularly useful for quickly capturing multiple exposures of objects under inspection to adjust for areas or components with significantly different levels of reflectance. You can specify the next index in the stepping sequence and the order in which indexes are executed. Multiple indexes can also be executed repeatedly.

Two operation modes (TriggerSequencer mode and CommandSequencer mode) are available for the Sequencer function.

Note

Sequencer function can not be used with Multi ROI Function.

■ About indexes (imaging conditions)

Up to 128 indexes can be configured. The following settings can be configured for each index. However, SequencerFrameNumber and SequencerSetNext can only be configured in TriggerSequencer mode.

■ Trigger Sequencer mode

With this mode, the Sequencer Trigger "pattern" is predetermined by the user. The user defines up to 128 different "indexes." The items indicated in the above index can be configured for each index. The operation of this mode is controlled using the following five commands.

[SequencerSetActive]

This allows you to confirm the currently configured index number.

[SequencerSetStart]

This configures the index number to execute at the start of TriggerSequencer mode.

[SequencerReset]

During TriggerSequencer mode operation, this switches the index number to be executed to that specified in [SequencerSetStart].

[SequencerRepetition]

This parameter applies to TriggerSequencer patterns which include an index whose [SequencerROINextIndex] is set to 0 (OFF). When the index whose [SequencerROINextIndex] is set to 0 (OFF) is finished executing, the value of Sequencer Repetition (range = 1-255) is decremented internally. If the result of the decrement is not zero, the TriggerSequencer pattern starts over from the index specified in SequencerSetStart. If the result of the decrement is zero, the status changes to Acquisition Stop and external triggers are not accepted.

Sample TriggerSequencer mode operation

User-defined Indexes (up to 128)

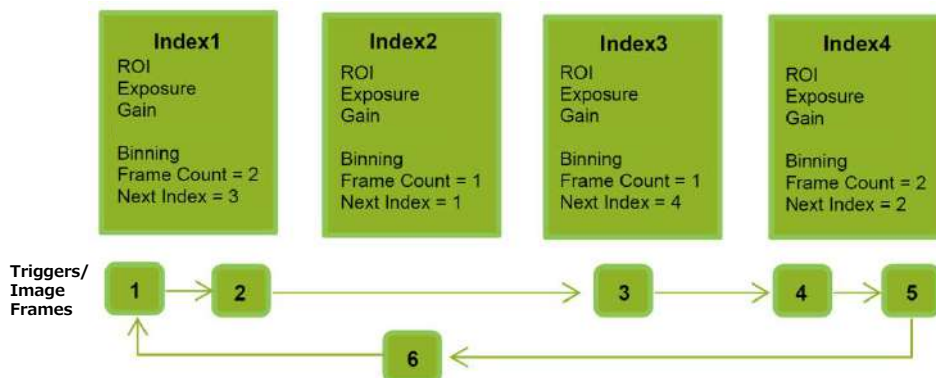

- 1** Specify "1" in [SequencerSetStart], and start TriggerSequencer mode with index 1.
- 2** Capture a 2-frame image with the first and second triggers.
- 3** For the next index, configure index 3 specified in [SequencerSetNext], and capture an image with the number of frames (number of triggers) specified in [SequencerFrameNumber].

Proceed to sequence from index 4 to index 2 to index 1.

Note

In addition to repeating multiple conditions as in the above example, you can specify "0" (which indicates the end of TriggerSequencer mode) in [SequencerSetNext] of index 2, and specify the number of repetitions in [SequencerRepetition].

■ **Command Sequencer mode**

As with TriggerSequencer mode, you can define up to 128 indexes beforehand in this mode. Set [SequencerCommandIndex] to point to one of your pre-configured indexes. This index will be executed on each trigger, until it is changed to point to a different index, typically by your vision application. In this way, Command Sequencer mode allows you to programmatically adjust your sequence in response to image analysis or input from other sensors.

Note

- The same index table will be executed for subsequent triggers unless the [CommandSequencerIndex] value is changed.
- [SequencerFrameNumber] and [SequencerSetNext] cannot be used in CommandSequencer mode.

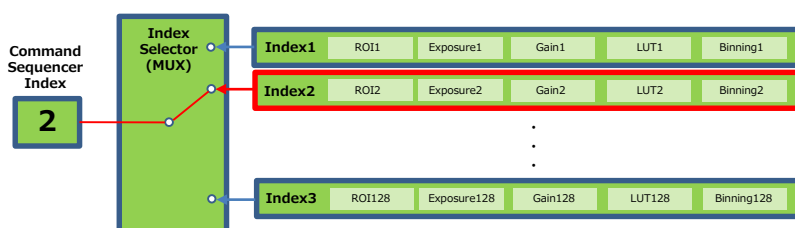

Chunk Data Function

The Chunk Data function adds camera configuration information to the image data that is output from the camera. Embedding camera configuration information in the image data allows you to use the serial number of the camera as a search key and find specific image data from among large volumes of image data. In addition, when images are shot with a single camera in sequence under multiple setting conditions, you can search for images by their setting conditions.

■ Configuring Chunk Data

1 Set [ChunkModeActive] to [True].

Note

When [ChunkModeActive] is set to [True], all items are automatically added as Chunk Data.

Caution

The Chunk Data function settings cannot be changed during image output. To change the settings, stop Acquisition.

Pulse Generator

By using this function, any signal can be generated inside the camera.
The following is an example of signal generation.

Settings

PulseGeneratorStartPoint = 2
 PulseGeneratorEndPoint = 6
 PulseGeneratorLength = 10
 PulseGeneratorPulseWidth = 4
 PulseGeneratorClearSyncMode = AsyncMode

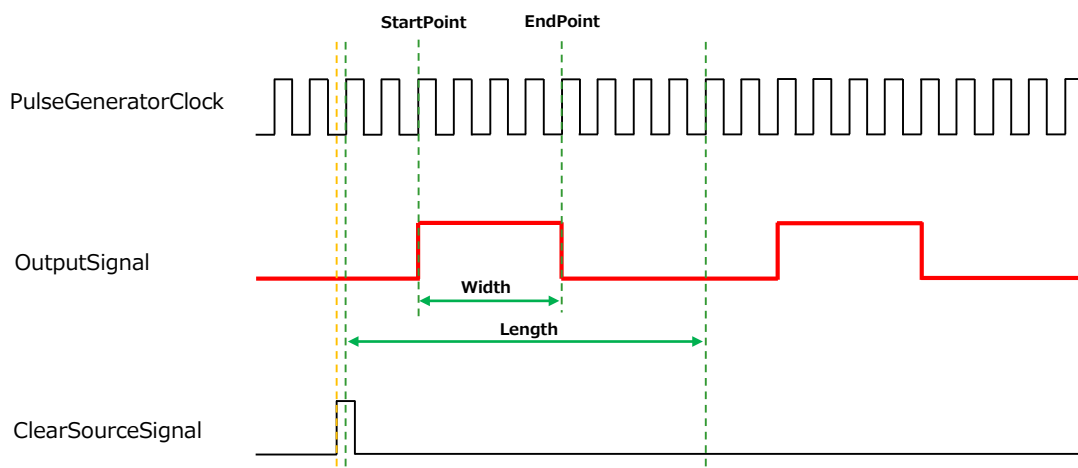

The table below shows the PulseGeneratorClearSource signals that can be set.

	Off	AcquisitionActive	FrameActive	ExposureActive	FVAL	LVAL	Action3	Action2	Action1	Action0	Software	PulseGenerator0	PulseGenerator1	PulseGenerator2	PulseGenerator3	UserOutput0	UserOutput1	UserOutput2	UserOutput3	Line4	Line5	Line6	Line10	Nand0Out	Nand1Out	Low	High	AcquisitionTriggerWait	FrameTriggerWait
PulseGenerator0		>	>	>	>	>						>	>	>	>	>	>	>	>	>	>	>	>	>	>	>	>	>	>
PulseGenerator1		>	>	>	>	>						>	>	>	>	>	>	>	>	>	>	>	>	>	>	>	>	>	>
PulseGenerator2		>	>	>	>	>						>	>	>	>	>	>	>	>	>	>	>	>	>	>	>	>	>	>
PulseGenerator3		>	>	>	>	>						>	>	>	>	>	>	>	>	>	>	>	>	>	>	>	>	>	>

Signals with * on each source signal name are specified for each video stream.

Example) FVAL: FVAL-Source0, FVAL-Source1, FVAL-Source2

Event Control Function

The Event Control Function is a function that outputs a signal change point inside the camera as information indicative of an event occurrence (event message) by using GVCP (GigE Vision Control Protocol).

■ Flow from detecting an event to sending an event message

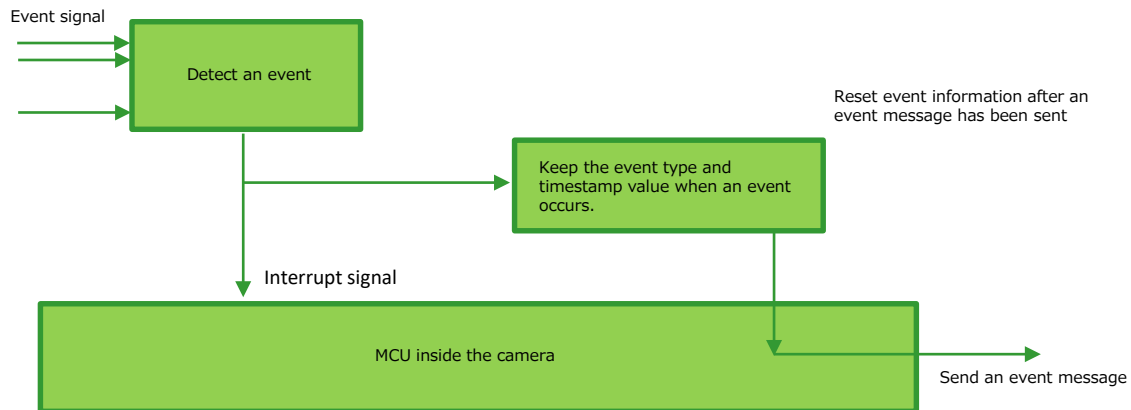

■ Events that can use the Event Control Function

Events that can use the Event Control Function are as follows. You can specify whether or not to send an event message when an event occurs at each event.

[external input signal]

Line1RisingEdgeData, Line1FallingEdgeData,
 Line2RisingEdgeData, Line2FallingEdgeData,
 Line3RisingEdgeData, Line3FallingEdgeData,
 Line4RisingEdgeData, Line4FallingEdgeData
 Line5RisingEdgeData, Line5FallingEdgeData,
 Line6RisingEdgeData, Line6FallingEdgeData
 Line8RisingEdgeData, Line8FallingEdgeData,
 Line10RisingEdgeData, Line10FallingEdgeData

[Sensor 0/Stream 0]

Stream0AcquisitionTriggerData,
 Stream0FrameStartData,
 Stream0FrameEndData,
 Stream0ExposureStartData,
 Stream0ExposureEndData,
 Stream0FVALStartData,
 Stream0FVALEndData,

[Sensor 1/Stream 1]

Stream1AcquisitionTriggerData
 Stream1FrameStartData
 Stream1FrameEndData
 Stream1ExposureStartData
 Stream1ExposureEndData
 Stream1FVALStartData
 Stream1FVALEndData

[Sensor 2/Stream 2]

Stream2AcquisitionTriggerData,
 Stream2FrameStartData,
 Stream2FrameEndData,
 Stream2ExposureStartData,
 Stream2ExposureEndData,
 Stream2FVALStartData,
 Stream2FVALEndData

Action Control Function

The Action Control Function is a function that executes the pre-configured action when the camera receives action commands. Action commands can send both unicast and broadcast messages and give instructions for actions to multiple cameras simultaneously by broadcasting them. A camera that has this function can even give instructions for actions to different types of multiple cameras. Although this function includes jitter and delays, it is useful for controlling multiple cameras simultaneously.

Actions are performed when the following three conditions are met.

1. ActionDeviceKey set to the camera and ActionDeviceKey in the action command match
2. ActionGroupKey set to the camera and ActionGroupKey in the action command match
3. ActionGroupMask set to the camera and GroupMask in the action command perform AND operation, and the result is not 0.

■ About the settings of the camera

1. Specify ActionDeviceKey.
2. Then, specify two actions that can be configured on the camera.
 - Action1
 - Select 1 in ActionSelector.
 - Specify ActionGroupMask [ActionSelector].
 - Specify ActionGroupKey [ActionSelector].
 - Action2
 - Select 2 in ActionSelector.
 - Specify ActionGroupMask [ActionSelector].
 - Specify ActionGroupKey [ActionSelector].
3. Set triggers (AcquisitionStart, AcquisitionEnd, FrameStart, AcquisitionTransferStart) to Action1 and Action2.

■ Setting example

Assume that the following settings have been pre-configured on the camera.

```

ActionDeviceKey      : 0x00001001
ActionGroupMask[1]   : 0x00000011
ActionGroupKey[1]    : 0x00000001
ActionGroupMask[2]   : 0x00000111
ActionGroupKey[2]    : 0x00000002
  
```

When the camera receives action commands (ActionDeviceKey:0x00001001, ActionGroupMask:0x00000011, ActionGroupKey: 0x00000002), Action2 is executed.

When the camera receives action commands (ActionDeviceKey:0x00001001, ActionGroupMask:0x00000011, ActionGroupKey: 0x00000001), ActionDevice and ActionGroupKey[1] match. However, the result of AND operation performed by ActionGroupMask is 0. Therefore, in this case, neither Action1 nor Action2 is executed.

Counter And Timer Control Function

This camera supports only the counter function.

The counter function counts up change points in the camera's internal signals using the camera's internal counter, and reads that information from the host side. This function is useful for verifying error conditions via the count value using internal camera operations. Four counters are available on the camera; Counter0, Counter1, Counter2, and Counter3. The functions that can be counted are fixed for each counter.

Counter0 : Counts the number of FrameStartTrigger.

Counter1 : Counts the number of ExposureStart.

Counter2 : Counts the number of SensorReadOut.

Counter3 : Counts the number of FrameTransferEnd.

When a problem occurs in a system that includes this camera, comparing the values from multiple counters allows you to verify the extent of normal operability and can be useful when investigating the cause of the problem.

■ Counter occurrence diagram

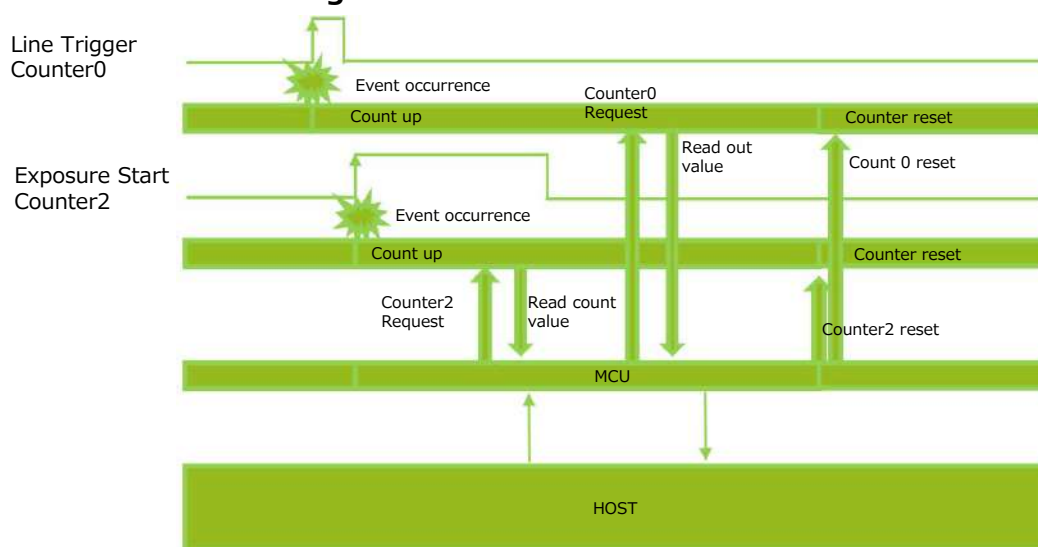

Note

You can reset a specific counter's count value by executing CounterReset[Counter0, Counter1, Counter2, Counter3].

■ Internal camera blocks

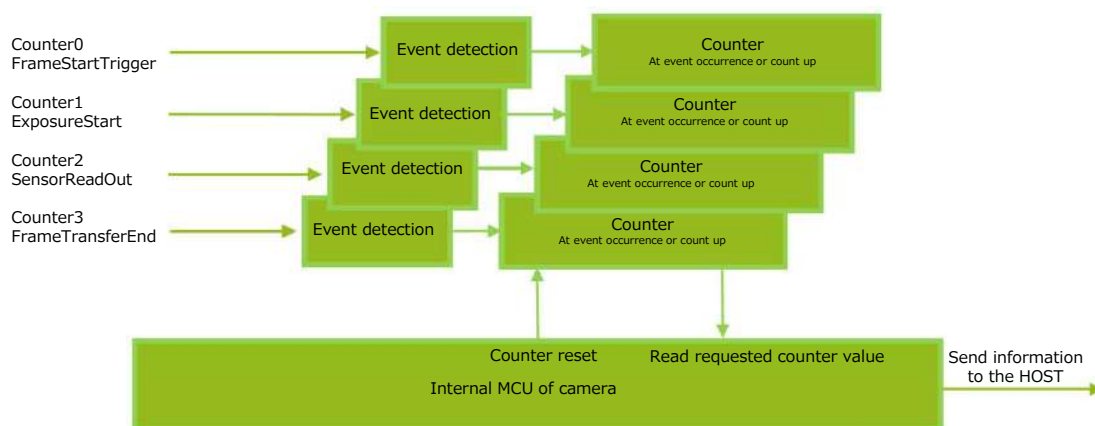

■ To use the counter function

Configure the settings as follows.

Four counters are available. Specify a counter (Counter0 to Counter3), and configure the settings.

Item	Setting value / selectable range	Description
Counter 0 ~ 3	Counter 0 ~ 3	Select the counter.
CounterEventSource	Counter0 Off, FrameStartTrigger Counter1 Off, ExposureStart Counter2 Off, SensorReadOut Counter3 Off, FrameTransferEnd	Select the counter event signal for which to read the count value. When set to Off, the counter operation will stop (but will not be reset).
CounterEventActivation	Rising Edge, Falling Edge	Specify timing at which to count. Counter0 Rising Edge Counter1 Rising Edge Counter2 Rising Edge Counter3 Falling Edge

PTP (Precision Time Protocol)

The camera can work as the slave for Precision Time Protocol defined in IEEE 1588. When the IEEE 1588 master clock exists in the network where the camera is connected, this function synchronizes the camera to the time of the master clock.

- Transport to be used
 - Multicast UDP datagram (224.0.1.129)
 - (However, Delay Resp is a unicast UDP datagram.)
- Destination port number
 - 319 : Sync, Delay Req, Pdelay Req, Pdelay Resp
 - 320 : Announce, Follow Up, Delay Resp, Pdelay Resp, Management, Signaling
- Items for synchronization
 - Time synchronization is performed. Frequency tuning is not performed.
- PTP time data
 - 80 bit (elapsed time in 1 ns, with 00:00:00, January 1 1970 set as the origin)
- Timestamp (this camera)
 - 64 bit* (PTP synchronization: LSB64bit* of PTP time data)
- Supported PTP messages
 - Announce message (receive only), Sync message (receive only),
 - Follow Up message (receive only), Delay Req message (send only),
 - Delay Resp message (receive only)

Cautions

- The Timestamp Tick Frequency register value is fixed at 1,000,000,000 (1 GHz).
 - When PTP synchronization is being performed, the Timestamp Reset function is disabled.
 - Because GenICam treats the timestamp (64 bit) as a 64 bit signed integer, 63 bit is actually timestamp data without the sign bit.
-

Setting List

Feature Properties

Item	Setting range	Default value	Description
a) DeviceControl			
Display/configure information related to the device.			
DeviceVendorName	—	"JAI Corporation"	Display the manufacturer name.
DeviceModelName	—	(model name)	Display the model name.
DeviceManufacturerInfo	—	See the possibilities	Display the manufacturer information.
DeviceVersion	—	—	Display the hardware version.
DeviceFirmwareVersion	—	—	Display the firmware version.
DeviceFpgaVersion	—	—	Display the FPGA version.
DeviceSerialNumber	—	—	Display the device ID.
DeviceUserID	Any	—	Set the user ID (16bytes) for the camera.
DeviceTLType	—	—	Transport Layer type of the device.
DeviceTLVersionMajor	—	—	Indicates the major version number of the GenICam XML file of the selected manifest entry.
DeviceTLVersionMinor	—	—	Indicates the minor version number of the GenICam XML file of the selected manifest entry.
DeviceTLVersionSubMinor	—	—	Indicates the subminor version number of the GenICam XML file of the selected manifest entry.
DeviceLinkSelector	—	—	Selects which Link of the device to control.
DeviceLinkSpeed	—	—	Indicates the speed of transmission negotiated on the specified Link.
DeviceLinkHeartbeatMode	0: On, 1: Off	—	Activate or deactivate the Link's heartbeat.
DeviceLinkHeartbeatTimeout	—	—	Controls the current heartbeat timeout of the specific Link.
DeviceStreamChannelCount	3	3	Indicates the number of streaming channels supported by the device.
DeviceEventChannelCount	1	1	Indicates the number of event channels supported by the device.
DeviceReset	—	—	Reset the device. (After the camera receives this command, it returns an ACK response. Then, execute reset.)
DeviceTemperatureSelector	0: Mainboard	Mainboard	Select the area of the camera's interior for which to display the temperature sensor's reading. (fixed Mainboard)
DeviceTemperature	—	—	Display the internal temperature (°C) of the camera.
Timestamp	0~9223372036854775807 (maximum value of unsigned 64-bit)	—	Display the timestamp value. Resets to 0 when the signed maximum 64-bit value is exceeded.
TimestampReset	—	—	Forcibly sets the timestamp's count value to 0.
TimestampLatch	—	—	Sets the timestamp's count value to TimestampLatchValue.
TimestampLatchValue (ns)	0~9223372036854775807 (maximum value of unsigned 64-bit)	0	
b) SourceControl			
Select the source(Sensor 0/Stream 0, Sensor 1/Stream 1, or Sensor 2/Stream 2)			
SourceCount	2	—	Display the number of sources.
SourceSelector	0:Source0 1:Source1 2:Source2	—	Selects the source to control.
SourceIDValue	—	—	Display the UniqueID for selected source. Source0 -> UniqueID 0 Source1 -> UniqueID 1 Source2 -> UniqueID 2

Item	Setting range	Default value	Description
c) ImageFormatControl			
Configure image format settings.			
SensorWidth	2064	2064	Display the maximum image width.
SensorHeight	1544	1544	Display the maximum image height.
SensorDigitizationBits	10: Ten, 12: Twelve	Ten	It shows how many bits the sensor is operating. Takes the following values for each PixelFormat. BayerRG8:Ten(10 Bits) BayerRG10:Twelve(12 Bits) BayerRG10Packed:Twelve(12 Bits) BayerRG12:Twelve(12 Bits) BayerRG12Packed:Twelve(12 Bits) Mono8:Ten(10 Bits) Mono10:Twelve(12 Bits) Mono10Packed:Twelve(12 Bits) Mono12:Twelve(12 Bits) Mono12Packed:Twelve(12 Bits)
WidthMax	2048	2048	Display the maximum image width.
HeightMax	1536	1536	Display the maximum image height.
Width	16~2048 step 16	2048	Set the image width.
Height	8~1536 step 4	1536	Set the image height.
OffsetX	0~2032	0	Set the horizontal offset.
OffsetY	0~1528	0	Set the vertical offset.
BinningHorizontalMode	Average, Sum	Sum	Set the mode for horizontal binning.
BinningHorizontal	1,2	1	Set the number of pixels in the horizontal direction for which to perform binning.
BinningVerticalMode	Sum	Sum	Set the mode for vertical binning. (Sum fixed)
BinningVertical	1,2	1	Set the number of pixels in the vertical direction for which to perform binning.
PixelFormat	—	BayerRG8	Set the pixel format. [Setting range] [SourceSelector] = Bayer color 17301513:BayerRG8 17825805:BayerRG10 17563687:BayerRG10Packed 17825809:BayerRG12 17563691:BayerRG12Packed [SourceSelector] = monochrome 17301505:Mono8 17825795:Mono10 17563652:Mono10Packed 17825797:Mono12 17563654:Mono12Packed *) The following modes can be set only when [VideoProcessBypassMode] is set to [On]. BayerRG12, BayerRG12Packed, Mono12, Mono12Packed
TestPattern	—	Off	Select the test image. [Setting range] 0:Off 1:GreyHorizontalRamp 2:GreyVerticalRamp 3:GreyHorizontalRampMoving The following items can be set only when [SourceSelector] = bayer color. 4:HorizontalColorBar 5:VerticalColorBar 6:HorizontalColorBarMoving

Item	Setting range	Default value	Description
d) AcquisitionControl			
Configure image capture settings.			
AcquisitionMode	0:SingleFrame, 1:MultiFrame, 2:Continuous	Continuous	Select the image capture mode.
AcquisitionStart	—	—	Start image capture.
AcquisitionStop	—	—	Stop image capture.
AcquisitionFrameCount	1~65535	1	In [MultiFrame] mode, set the number of frames to capture.
AcquisitionFrameRate	0.125~		Display the frame rate as a frequency. (unit: Hz) The maximum value varies depending on the PixelFormat setting and the ROI setting.
TriggerSelector	0:AcquisitionStart, 1:AcquisitionEnd, 3:FrameStart, 4:AcquisitionTransferStart	AcquisitionStart	Select the trigger operation.
TriggerMode	0:Off, 1:On	Off	Select the trigger mode.
TriggerSoftware	—	—	Execute the software trigger.
TriggerSource	—	—	Select the trigger signal source. [Setting range] 7: PulseGenerator0, 8: PulseGenerator1, 9: PulseGenerator2 10: PulseGenerator3, 11: UserOutput0, 12: UserOutput1 13: UserOutput2, 14: UserOutput3, 15: Action0 16: Action1, 17: Action2, 18: Action3 19: Software, 23: Line4, 24: Line5 25: Line6, 29: Line10, 36: Nand0Out 37: Nand1Out
TriggerActivation	1:RisingEdge 2:FallingEdge 3:LevelHigh 4:LevelLow	RisingEdge	Select the polarity of the trigger signal (i.e., location of signal at which trigger is applied).
TriggerOverlap	1:ReadOut	ReadOut	Select the trigger overlap operation. (ReadOut fixed)
TriggerDelay	0~500000	0	Set the time of exposure start from trigger input. (unit: μ s)
ExposureMode	0: Off, 1: Timed, 2: TriggerWidth	Timed	Select the exposure mode.
ExposureTime	1 μ s ~	—	Set the exposure time. (μ s) The specifiable range varies depending on the [AcquisitionFrameRate] setting. The actual exposure time is the set value plus the image sensor offset 13.7 μ s.
ExposureAuto	0: Off, 1: Once, 2: Continuous	Off	Set whether to enable auto exposure.
ExposureModeOption	0: Off, 1: RCT	Off	Set whether to enable RCT mode.
AcquisitionSyncMode	0: AsyncMode, 1: SyncMode	SyncMode	Set an AcquisitionSyncMode.

Item	Setting range	Default value	Description
e) AnalogControl			
Configure analog control settings.			
GainSelector	0:AnalogAll, 1:DigitalRed, 3:DigitalBlue	AnalogAll	Select the gain to configure. (DigitalRed, DigitalBlue are available for Bayer color only)
Gain	AnalogAll x1.0 ~ x16.0 DigitalRed x0.447~x5.624 DigitalBlue x0.447~x5.624	AnalogAll, x1.0 DigitalRed, x1.0 DigitalBlue, x1.0	Set the gain value for the gain setting selected in [GainSelector]. (DigitalRed, DigitalBlue are available for Bayer color only)
GainAuto	0:Off, 1:Once, 2:Continuous	Off	Enable/disable gain auto adjustment. [Once] automatically changes to [Off] when the signal level converges once.
BlackLevelSelector	0:All, 1:Red, 3:Blue	All	Select the black level to configure. (Red, Blue are available for Bayer color only)
BlackLevel	All, -133~255 Red, -64~ 64 Blue -64~ 64	All, 0 Red, 0 Blue 0	Set the black level value. (Red, Blue are available for Bayer color only)
BalanceWhiteAuto	0:Off, 1:Once, 2:Continuous, 3:Preset3200K, 4:Preset5000K, 5:Preset6500K, 6:Preset7500K	Off	Enable/disable auto white balance. (Bayer color only)
BalanceWhiteAutoAreaSelector	—	—	Select the area for which to configure [BalanceWhiteAutoAreaEnable]. (Bayer color only) [Setting range] 15:HighLeft, 14:HighMidLeft, 13:HighMidRight, 12:HighRight, 11:MidHighLeft, 10:MidHighMidLeft, 9:MidHighMidRight, 8:MidHighRight, 7:MidLowLeft, 6:MidLowMidLeft, 5:MidLowMidRight, 4:MidLowRight, 3:LowLeft, 2:LowMidLeft, 1:LowMidRight, 0:LowRight
BalanceWhiteAutoAreaEnable	True, False		Enable/disable the photometry area selected in [BalanceWhiteAutoAreaSelector].
BalanceWhiteAutoAreaEnableAll	True, False		True: Operate BalanceWhiteAuto with all areas designated as photometry areas, regardless of the individual enabled/disabled photometry area states configured in [BalanceWhiteAutoAreaSelector]. False: Operate BalanceWhiteAuto according to the individual enabled/disabled photometry area states configured in [BalanceWhiteAutoAreaSelector].
BalanceWhiteAutoSpeed	1 to 8	4	Set the response speed for BalanceWhiteAuto. (8 is the fastest)
BalanceWhiteAutoResult	—	—	Display the results of BalanceWhiteAuto. 0: Idle (Balance White Auto is not executed yet.) 1: Processing (Balance White Auto is processing.) 2: Converging (Balance White Auto is converging.) 3:Succeeded (Balance White Auto was Succeeded.) 4: Error1 (G image was too bright) 5: Error2 (G image was too dark) 6: Error3 (Timeout error has occurred. Please try again.) 7: Error4 (Could not processing.) 8: Error5 (R or B image was out of range.)
Gamma	0.45, 0.5, 0.55, 0.6, 0.65, 0.75, 0.8, 0.9, 1.0	0.45	Set the gamma value.
LUTMode	0:Off, 1:Gamma, 2:LUT	Off	Select the LUT mode.

Item	Setting range	Default value	Description
f) AutoLevelControl			
Configure AutoLevelControl.			
ALCReference	30 ~ 95	50	Set the target level for ALC. (unit: %)
ALCAreaSelector	—	—	Select the area for which to configure [ALCAreaEnable]. [Setting range] 15:HighLeft, 14:HighMidLeft, 13:HighMidRight, 12:HighRight, 11:MidHighLeft, 10:MidHighMidLeft, 9:MidHighMidRight, 8:MidHighRight, 7:MidLowLeft, 6:MidLowMidLeft, 5:MidLowMidRight, 4:MidLowRight, 3:LowLeft, 2:LowMidLeft, 1:LowMidRight, 0:LowRight
ALCAreaEnable	True, False	True	Enable/disable the photometry area selected in [ALCAreaSelector].
ALCAreaEnableAll	True, False	True	True: Operate ALC with all areas designated as photometry areas, regardless of the individual enabled/disabled photometry area states configured in [ALCAreaSelector]. False: Operate ALC according to the individual enabled/disabled photometry area states configured in [ALCAreaSelector].
ALCControlSpeed	1 ~ 8	4	Set the response speed for ALC. (8 is the fastest.)
AutoControlStatus	—	Idle	Allows confirmation of the current operation area during ALC operation.
ExposureAutoControlMin	100 ~	—	Set the minimum value for the ExposureTime control range
ExposureAutoControlMax	101 ~	—	Set the maximum value for the ExposureTime control range
GainAutoControlMin	1 ~ 15	1	Set the minimum value for the GainAuto control range
GainAutoControlMax	2 ~ 16	16	Set the maximum value for the GainAuto control range
g) LUTControl			
Configure LUT settings.			
LUTSelector	Red, Green, Blue	Red	Select the LUT channel to control.
LUTIndex	0~256	0	Set the LUT index table number.
LUTValue	0~4095	Gamma±1.0	Set the LUT value.
h) DigitalIOcontrol			
Configure settings for digital input/output.			
LineSelector	—	Line2	Select the input/output to configure. [Setting range] 20: Line1, 21: Line2, 22: Line3, 23: Line4, 24: Line5 25: Line6, 27: Line8, 29: Line10 53: Nand0In1, 54: Nand0In2, 55: Nand1In1, 56: Nand1In2 63: TimeStampReset
LineMode	0: Input, 1: Output, 2: InternalConnection	—	Display the input/output status (whether it is input or output).
LineInverter	True, False	False	Enable/disable polarity inversion for the selected input signal or output signal.
LineStatus	True, False	—	Display the status of the input signal or output signal (True: High, False: Low).
LineStatusAll	—	—	Display the input/output signal status. The state is shown with 16 bits. Bit assignments are as follows. [0]:Line1, [1]:Line2, [2]:Line3, [3]:Line4 [4]:Line5, [5]:Line6, [6]:- , [7]:Line8 [8]: -, [9]:Line10, [10]:- , [11]:- [12]: -, [13]:-, [14]:- , [15]:-
LineSource	—	—	Select the line source signal for the item selected in [Line Selector]. [Setting range] 0:Off (LineSelector=TimeStampReset Only) 1:AcquisitionActive-Source0, 45:AcquisitionActive-Source1, 57:AcquisitionActive-Source2, 2:FrameActive-Source0, 46:FrameActive-Source1, 58:FrameActive-Source2, 4:ExposureActive-Source0, 48:ExposureActive-Source1, 60:ExposureActive-Source2 5:FVAL-Source0, 49:FVAL-Source1, 61:FVAL-Source2 6:LVAL-Source0, 50:LVAL-Source1, 62:LVAL-Source2 43:AcquisitionTriggerWait-Source0, 51:AcquisitionTriggerWait-Source1, 63:AcquisitionTriggerWait-Source2, 44:FrameTriggerWait-Source0, 52:FrameTriggerWait-Source1, 64:FrameTriggerWait-Source2 7-10:PulseGenerator0-3, 11-14:UserOutput0-3 23:Line4 TTL In1, 24:Line5 Opt In1, 25:Line6 Opt In2, 29:Line10 TTL In2 36:Nand0 Out, 37:Nand1 Out 40:- (Not selectable for Output) 41:Low, 42:High
LineFormat	2:TTL, 5:OptoCoupled, 7:Internal Signal	—	Display the signal format.
OptInFilter	Off, 10us, 100us, 500us, 1ms, 5ms, 10ms	Off	Select the filter to remove noise from the OptIn input signal of Digital I/O.
UserOutputSelector	0: UserOutput0 1: UserOutput1 2: UserOutput2 3: UserOutput3	UserOutput0	Set the UserOutput signal.
UserOutputValue	True, False	False	Set the value for the UserOutput selected in [UserOutputSelector].

Item	Setting range	Default value	Description
i) CounterAndTimerControl			Configure counter settings. (This camera only supports counter functions.)
CounterSelector	0: Counter0 1: Counter1 2: Counter2 3: Counter3	—	Select the counter.
CounterEventSource	—	Off	Assign the counter event signal for which you want to read the count value to a dedicated counter, and read the value. [Setting range] Counter0 0:Off, 1:FrameTrigger Counter1 0:Off, 1:ExposureStart Counter2 0:Off, 1:SensorReadOut Counter3 0:Off, 1:FrameTransferEnd
CounterEventActivation	—	—	Set the count timing. The setting value is fixed with the following data. Counter0 RisingEdge Counter1 RisingEdge Counter2 RisingEdge Counter3 FallingEdge
CounterReset	—	—	Reset the counter.
CounterValue	0~65535	0	Display the count value.
CounterStatus	—	—	Display the counter status. 0: CounterIdle: Idle 1: CounterTriggerWait 2: CounterActive: Counting 3: CounterCompleted:Complete counting 4: CounterOverflow: Count value exceeded the maximum value.
j) ActionControl			Configure settings for action control.
ActionDeviceKey	0x00000000~ 0xFFFFFFFF	—	An action command is executed if this ActionDeviceKey matches the DeviceKey contained in the action command message.
ActionQueueSize	—	—	Indicates the size of ActionQueue.
ActionSelector	1,2	1	Select the ActionSelector.
ActionGroupMask	0x00000000~ 0xFFFFFFFF	—	An action command is executed if the result of an AND operation of GroupMask contained in this ActionGroupMask and an action command message is not 0.
ActionGroupKey	0x00000000~ 0xFFFFFFFF	—	An action command is executed if this ActionGroupKey matches the GroupKey contained in the action command message.

Item	Setting range	Default value	Description
k) EventControl			
EventSelector	—	—	Select the event to send the event message. [Setting range] 0:AcquisitionStart / 1:AcquisitionEnd 12:Line1 RisingEdge / 13:Line1 FallingEdge 14:Line2 RisingEdge / 15:Line2 FallingEdge 16:Line3 RisingEdge / 17:Line3 FallingEdge 18:Line4 RisingEdge / 19:Line4 FallingEdge 20:Line5 RisingEdge / 21:Line5 FallingEdge 22:Line6 RisingEdge / 23:Line6 FallingEdge 24:Line8 RisingEdge / 25:Line8 FallingEdge 26:Line10 RisingEdge/ 27:Line10 FallingEdge 40:Stream0 AcquisitionTrigger, 41:Stream1 AcquisitionTrigger, 54:Stream2 AcquisitionTrigger 42:Stream0 FrameStart, 43:Stream1 FrameStart, 55:Stream2 FrameStart 44:Stream0 FrameEnd, 45:Stream1 FrameEnd, 56:Stream2 FrameEnd 46:Stream0 ExposureStart, 47:Stream1 ExposureStart, 57:Stream2 ExposureStart 48:Stream0 ExposureEnd, 49:Stream1 ExposureEnd, 58:Stream2 ExposureEnd 50:Stream0 FVALStart, 51:Stream1 FVALStart, 59:Stream2 FVALStart 52:Stream0 FVALEnd, 53:Stream1 FVALEnd, 60:Stream2 FVALEnd
EventNotification	On, Off	Off	Sets whether or not to send an event message when an event selected by [EventSelector] occurs.
EventLine1RisingEdgeData			
EventLine1RisingEdge			Display the EventID(0x9310).
EventLine1RisingEdgeTimestamp			Displays the Timestamp value when an event occurs.
EventLine1RisingEdgeFrameID			Displays the FrameID value when an event occurs.
EventLine1FallingEdgeData			
EventLine1FallingEdge			Display the EventID(0x9318).
EventLine1FallingEdgeTimestamp			Displays the Timestamp value when an event occurs.
EventLine1FallingEdgeFrameID			Displays the FrameID value when an event occurs.
EventLine2RisingEdgeData			
EventLine2RisingEdge			Display the EventID(0x9311)を.
EventLine2RisingEdgeTimestamp			Displays the Timestamp value when an event occurs.
EventLine2RisingEdgeFrameID			Displays the FrameID value when an event occurs.
EventLine2FallingEdgeData			
EventLine2FallingEdge			Display the EventID(0x9319).
EventLine2FallingEdgeTimestamp			Displays the Timestamp value when an event occurs.
EventLine2FallingEdgeFrameID			Displays the FrameID value when an event occurs.
EventLine3RisingEdgeData			
EventLine3RisingEdge			Display the EventID(0x9312).
EventLine3RisingEdgeTimestamp			Displays the Timestamp value when an event occurs.
EventLine3RisingEdgeFrameID			Displays the FrameID value when an event occurs.
EventLine3FallingEdgeData			
EventLine3FallingEdge			Display the EventID(0x931A).
EventLine3FallingEdgeTimestamp			Displays the Timestamp value when an event occurs.
EventLine3FallingEdgeFrameID			Displays the FrameID value when an event occurs.
EventLine4RisingEdgeData			
EventLine4RisingEdge			Display the EventID(0x9313).
EventLine4RisingEdgeTimestamp			Displays the Timestamp value when an event occurs.
EventLine4RisingEdgeFrameID			Displays the FrameID value when an event occurs.
EventLine4FallingEdgeData			
EventLine4FallingEdge			Display the EventID(0x931B).
EventLine4FallingEdgeTimestamp			Displays the Timestamp value when an event occurs.
EventLine4FallingEdgeFrameID			Displays the FrameID value when an event occurs.
EventLine5RisingEdgeData			
EventLine5RisingEdge			Display the EventID(0x9314).
EventLine5RisingEdgeTimestamp			Displays the Timestamp value when an event occurs.
EventLine5RisingEdgeFrameID			Displays the FrameID value when an event occurs.
EventLine5FallingEdgeData			
EventLine5FallingEdge			Display the EventID(0x931C).
EventLine5FallingEdgeTimestamp			Displays the Timestamp value when an event occurs.
EventLine5FallingEdgeFrameID			Displays the FrameID value when an event occurs.
EventLine6RisingEdgeData			
EventLine6RisingEdge			Display the EventID(0x9315).
EventLine6RisingEdgeTimestamp			Displays the Timestamp value when an event occurs.
EventLine6RisingEdgeFrameID			Displays the FrameID value when an event occurs.
EventLine6FallingEdgeData			
EventLine6FallingEdge			Display the EventID(0x931D).
EventLine6FallingEdgeTimestamp			Displays the Timestamp value when an event occurs.
EventLine6FallingEdgeFrameID			Displays the FrameID value when an event occurs.
EventLine8RisingEdgeData			
EventLine8RisingEdge			Display the EventID(0x9317).
EventLine8RisingEdgeTimestamp			Displays the Timestamp value when an event occurs.
EventLine8RisingEdgeFrameID			Displays the FrameID value when an event occurs.
EventLine8FallingEdgeData			
EventLine8FallingEdge			Display the EventID(0x931F).
EventLine8FallingEdgeTimestamp			Displays the Timestamp value when an event occurs.
EventLine8FallingEdgeFrameID			Displays the FrameID value when an event occurs.
EventLine10RisingEdgeData			
EventLine10RisingEdge			Display the EventID(0x9341).
EventLine10RisingEdgeTimestamp			Displays the Timestamp value when an event occurs.
EventLine10RisingEdgeFrameID			Displays the FrameID value when an event occurs.

Item	Setting range	Default value	Description
EventLine10FallingEdgeData			
EventLine10FallingEdge			Display the EventID(0x9361).
EventLine10FallingEdgeTimestamp			Displays the Timestamp value when an event occurs.
EventLine10FallingEdgeFrameID			Displays the FrameID value when an event occurs.
EventStream0AcquisitionTriggerData			
EventStream0AcquisitionTrigger			Display the EventID(0x9002).
EventStream0AcquisitionTriggerTimestamp			Displays the Timestamp value when an event occurs.
EventStream0AcquisitionTriggerFrameID			Displays the FrameID value when an event occurs.
EventStream1AcquisitionTriggerData			
EventStream1AcquisitionTrigger			Display the EventID(0x9520).
EventStream1AcquisitionTriggerTimestamp			Displays the Timestamp value when an event occurs.
EventStream1AcquisitionTriggerFrameID			Displays the FrameID value when an event occurs.
EventStream2AcquisitionTriggerData			
EventStream2AcquisitionTrigger			Display the EventID(0x9521).
EventStream2AcquisitionTriggerTimestamp			Displays the Timestamp value when an event occurs.
EventStream2AcquisitionTriggerFrameID			Displays the FrameID value when an event occurs.
EventStream0FrameStartData			
EventStream0FrameStart			Display the EventID(0x9300).
EventStream0FrameStartTimestamp			Displays the Timestamp value when an event occurs.
EventStream0FrameStartFrameID			Displays the FrameID value when an event occurs.
EventStream1FrameStartData			
EventStream1FrameStart			Display the EventID(0x95B0).
EventStream1FrameStartTimestamp			Displays the Timestamp value when an event occurs.
EventStream1FrameStartFrameID			Displays the FrameID value when an event occurs.
EventStream2FrameStartData			
EventStream2FrameStart			Display the EventID(0x95B1).
EventStream2FrameStartTimestamp			Displays the Timestamp value when an event occurs.
EventStream2FrameStartFrameID			Displays the FrameID value when an event occurs.
EventStream0FrameEndData			
EventStream0FrameEnd			Display the EventID(0x9301).
EventStream0FrameEndTimestamp			Displays the Timestamp value when an event occurs.
EventStream0FrameEndFrameID			Displays the FrameID value when an event occurs.
EventStream1FrameEndData			
EventStream1FrameEnd			Display the EventID(0x95C0).
EventStream1FrameEndTimestamp			Displays the Timestamp value when an event occurs.
EventStream1FrameEndFrameID			Displays the FrameID value when an event occurs.
EventStream2FrameEndData			
EventStream2FrameEnd			Display the EventID(0x95C1).
EventStream2FrameEndTimestamp			Displays the Timestamp value when an event occurs.
EventStream2FrameEndFrameID			Displays the FrameID value when an event occurs.
EventStream0ExposureStartData			
EventStream0ExposureStart			Display the EventID(0x9003).
EventStream0ExposureStartTimestamp			Displays the Timestamp value when an event occurs.
EventStream0ExposureStartFrameID			Displays the FrameID value when an event occurs.
EventStream1ExposureStartData			
EventStream1ExposureStart			Display the EventID(0x9630).
EventStream1ExposureStartTimestamp			Displays the Timestamp value when an event occurs.
EventStream1ExposureStartFrameID			Displays the FrameID value when an event occurs.
EventStream2ExposureStartData			
EventStream2ExposureStart			Display the EventID(0x9631).
EventStream2ExposureStartTimestamp			Displays the Timestamp value when an event occurs.
EventStream2ExposureStartFrameID			Displays the FrameID value when an event occurs.
EventStream0ExposureEndData			
EventStream0ExposureEnd			Display the EventID(0x9004).
EventStream0ExposureEndTimestamp			Displays the Timestamp value when an event occurs.
EventStream0ExposureEndFrameID			Displays the FrameID value when an event occurs.
EventStream1ExposureEndData			
EventStream1ExposureEnd			Display the EventID(0x9640).
EventStream1ExposureEndTimestamp			Displays the Timestamp value when an event occurs.
EventStream1ExposureEndFrameID			Displays the FrameID value when an event occurs.
EventStream2ExposureEndData			
EventStream2ExposureEnd			Display the EventID(0x9641).
EventStream2ExposureEndTimestamp			Displays the Timestamp value when an event occurs.
EventStream2ExposureEndFrameID			Displays the FrameID value when an event occurs.
EventStream0FVALStartData			
EventStream0FVALStart			Display the EventID(0x9320).
EventStream0FVALStartTimestamp			Displays the Timestamp value when an event occurs.
EventStream0FVALStartFrameID			Displays the FrameID value when an event occurs.
EventStream1FVALStartData			
EventStream1FVALStart			Display the EventID(0x9650).
EventStream1FVALStartTimestamp			Displays the Timestamp value when an event occurs.
EventStream1FVALStartFrameID			Displays the FrameID value when an event occurs.
EventStream2FVALStartData			
EventStream2FVALStart			Display the EventID(0x9651).
EventStream2FVALStartTimestamp			Displays the Timestamp value when an event occurs.
EventStream2FVALStartFrameID			Displays the FrameID value when an event occurs.

Item	Setting range	Default value	Description
EventStream0FVALEndData			
EventStream0FVALEnd			Display the EventID(0x9321).
EventStream0FVALEndTimestamp			Displays the Timestamp value when an event occurs.
EventStream0FVALEndFrameID			Displays the FrameID value when an event occurs.
EventStream1FVALEndData			
EventStream1FVALEnd			Display the EventID(0x9660).
EventStream1FVALEndTimestamp			Displays the Timestamp value when an event occurs.
EventStream1FVALEndFrameID			Displays the FrameID value when an event occurs.
EventStream2FVALEndData			
EventStream2FVALEnd			Display the EventID(0x9661).
EventStream2FVALEndTimestamp			Displays the Timestamp value when an event occurs.
EventStream2FVALEndFrameID			Displays the FrameID value when an event occurs.
l) UserSetControl			Configure user settings.
UserSetSelector	0: Default, 1: UserSet1, 2: UserSet2, 3: UserSet3	Default	Select the user settings.
UserSetLoad	—	—	Load user settings. (If 0 is specified, the factory default setting is read.)
UserSetSave	—	—	Save the current setting values as user settings. (If 0 is specified, UserSetSave is invalid.)
m) SequencerControl			Configure sequencer settings.
SequencerMode	Off, On	Off	Enable/disable [SequencerMode].
SequencerModeSelect	0:TriggerSequencerMode, 1:CommandSequencerMode	TriggerSequencerMode	Select the sequencer mode.
SequencerSetSelector	1~128	1	Select the index number to configure.
SequencerWidth	16~2048 step 16	2048	Set the width of the selected SequencerIndex.
SequencerHeight	8~1536 step 4	1536	Set the height of the selected SequencerIndex.
SequencerOffsetX	0~2032	0	Set the horizontal offset value for the selected SequencerIndex.
SequencerOffsetY	0~1528	0	Set the vertical offset value for the selected SequencerIndex.
SequencerBinningHorizontal	0, 1	0	For the selected SequencerIndex, set the number of pixels in the horizontal direction for which to perform binning. In binning mode, the setting value of BinningHorizontalMode is applied.
SequencerBinningVertical	0, 1	0	For the selected SequencerIndex, set the number of pixels in the vertical direction for which to perform binning. In binning mode, the setting of BinningVerticalMode is applied.
SequencerFrameCount	—	—	Set the FrameCount value for the selected SequencerIndex.
SequencerExposureTime	1μs ~	—	Set the exposure time for the selected SequencerIndex.
SequencerGainAnalogAll	x1.0 ~ x16.0	x1.0	Set the GainAnalogAll value.
SequencerGainDigitalRed	x0.447~x5.624	x1.0	Set the DigitalRed Gain value for the selected SequencerIndex.
SequencerGainDigitalBlue	x0.447~x5.624	x1.0	Set the DigitalBlue Gain value for the selected SequencerIndex.
SequencerBlackLevelAll	-133~255	0	Set the BlackLevelAll value for the selected SequencerIndex.
SequencerLutEnable	True, False	False	Set the LutEnable value for the selected SequencerIndex.
SequencerSetNext	0 ~ 128		Set the next index to be displayed for the selected SequencerIndex. (Enabled only for TriggerSequencer.) If 0 is specified, the operation of Sequencer is stopped.
SequencerRepetition	1~255	1	Set the repeat count for the sequencer.
SequencerSetActive	1~128	1	Displays the sequencer set number.
SequencerSetStart	1~128	1	Specify the first index number to switch to when starting [TriggerSequencerMode].
SequencerCommandIndex	1~128	1	Set this to change the SequencerIndex. (Enabled only for CommandSequencer.)
SequencerReset	—	—	In [TriggerSequencerMode], reset the current index number to the number configured in [SequencerSetStart].

Item	Setting range	Default value	Description
n) ChunkDataControl			
Configure chunk control settings.			
ChunkModeActive	True, False	False	Set whether to enable ChunkData
ChunkBinningHorizontal	—	—	(ChunkID 2022h : DataType Float)
ChunkBinningVertical	—	—	(ChunkID 2023h : DataType Float)
ChunkTimestamp	—	—	(ChunkID 2014h : DataType Float)
ChunkLineStatusAllOnExposureStart	—	—	(ChunkID 2015h : DataType String)
ChunkLineStatusAllOnFVALStart	—	—	(ChunkID 2016h : DataType String)
ChunkCounterSelector	0: Counter0 1: Counter1 2: Counter2	—	Select the counter to display the ChunkCounterValue.
ChunkCounterValue	—	—	(DataType Float) CounterValue[FrameTrigger]: 200Eh CounterValue[ExposureStart]: 200Fh CounterValue[SensorReadout]: 2010h
ChunkExposureTime	—	—	(ChunkID 2004h : DataType Float)
ChunkGainSelector	0:AnalogAll, 1:DigitalRed, 3:DigitalBlue	—	Select the Gain to display the ChunkGain.
ChunkGain	—	—	(DataType Float) Gain[DigitalRed]: 2006h Gain[AnalogAll]: 201Fh Gain[DigitalBlue]: 2007h
ChunkBlackLevelSelector	0:All, 1:Red, 3:Blue	—	Select the BlackLevel to display the ChunkBlackLevel.
ChunkBlackLevel	—	—	(DataType Float) BlackLevel[DigitalRed]: 2009h BlackLevel[DigitalAll]: 2008h BlackLevel[DigitalBlue]: 200Ah
ChunkDeviceSerialNumber	—	—	(ChunkID 2017h : DataType String)
ChunkDeviceTemperatureSelector	0:Mainboard	—	Select the device to display the ChunkDeviceTemperature.
ChunkDeviceTemperature	—	—	(ChunkID 2019h : DataType Float)
ChunkDeviceUserID	—	—	(ChunkID 2018h : DataType String)
o) TestControl			
TestPendingAck	—	—	—

Item	Setting range	Default value	Description
p) TransportLayerControl			
Display information on transport layer control.			
PayloadSize			Display the payload size.
GigEVision			
GevCurrentPhysicalLinkConfiguration	SingleLink	SingleLink	Display the status for LinkConfiguration. (fixed at SingleLink).
GevSupportedOptionSelector			Select the supported options for GigEVision. [Setting range] SingleLink, MultiLink, StaticLAG, DynamicLAG, PAUSEFrameReception, PAUSEFrameGeneration, IPConfigurationLLA, IPConfigurationDHCP, IPConfigurationPersistentIP, StreamChannelSourceSocket, StandardIDMode, MessageChannelSourceSocket, CommandsConcatenation, WriteMem, PacketResend, Event,EventData, PendingAck, IEEE1588, Action, UnconditionalAction, ScheduledAction, PrimaryApplicationSwitchover, ExtendedStatusCodes, ExtendedStatusCodesVersion2_0, DiscoveryAckDelay, DiscoveryAckDelayWritable, TestData, ManifestTable, CCPApplicationSocket, LinkSpeed, HeartbeatDisable, SerialNumber, UserDefinedName, StreamChannel0BigAndLittleEndian, StreamChannel0MultiZone, StreamChannel0PacketResendDestination, StreamChannel0AllInTransmission, StreamChannel0UnconditionalStreaming, StreamChannel0ExtendedChunkData, StreamChannel1BigAndLittleEndian, StreamChannel1MultiZone, StreamChannel1PacketResendDestination, StreamChannel1AllInTransmission, StreamChannel1UnconditionalStreaming, StreamChannel1ExtendedChunkData, StreamChannel2BigAndLittleEndian, StreamChannel2MultiZone, StreamChannel2PacketResendDestination, StreamChannel2AllInTransmission, StreamChannel2UnconditionalStreaming, StreamChannel2ExtendedChunkData
GevSupportedOption	True, False	—	Display whether support for the function selected in GevSupportedOptionSelector is enabled or disabled.
GevInterfaceSelector	0	0	The value for this item is fixed at 0.
GevMACAddress	—	—	Display the MAC address.
GevPAUSEFrameReception	False	False	This item is not supported. (fixed at False)
GevPAUSEFrameTransmission	False	False	This item is not supported. (fixed at False)
GevCurrentIPConfigurationLLA	True	True	Display whether the current IP configuration is calibrated by LLA (link-local address). (fixed at [True])
GevCurrentIPConfigurationDHCP	True, False	True	Select whether to set the IP configuration to DHCP.
GevCurrentIPConfigurationPersistentIP	True, False	True	Select whether to set the IP configuration to Persistent IP.
GevCurrentIPAddress	—	—	Display the IP address.
GevCurrentSubnetMask	—	—	Display the subnet.
GevCurrentDefaultGateway	—	—	Display the default gateway.
GevIPConfigurationStatus	—	—	Display the current IP configuration status. (None, PersistentIP, DHCP, LLA, ForceIP)
GevPersistentIPAddress	—	—	Set the persistent IP address.
GevPersistentSubnetMask	—	—	Set the persistent subnet mask.
GevPersistentDefaultGateway	—	—	Set the persistent default gateway.
GevIEEE1588	True, False	False	Enables the IEEE 1588 Precision Time Protocol to control the timestamp register.
GevIEEE1588ClockAccuracy	—	—	Indicates the expected accuracy of the device clock when it is the grandmaster, or in the event it becomes the grandmaster. [Setting range] 0:Within25ns, 1:Within100ns, 2:Within250ns, 3:Within1us, 4:Within2p5u, 5:Within10us, 6:Within25us, 7:Within100us, 8:Within250us, 9:Within1ms, 10:Within2p5ms, 11:Within10ms, 12:Within25ms, 13:Within100ms, 14:Within250ms, 15:Within1s, 16:Within10s, 17:GreaterThan10s, 18:AlternatePTPProfile, 19:Unknown, 20:Reserved
GevIEEE1588Status	—	—	Display the current status. 0: Initializing, 1: Faulty, 2: Disabled 3: Listening, 4: PreMaster, 5: Master 6: Passive, 7: Uncalibrated, 8: Slave
GevGVCPExtendedStatusCodesSelector	0:Version1_1, 1:Version2_0	—	Selects the GigE Vision version to control extended status codes for.
GevGVCPExtendedStatusCodes	True, False	False	Enables the generation of extended status codes.
GevGVCPPendingAck	True, False	False	Enables the generation of PENDING_ACK.
GevGVSPExtendedIDMode	Off, On	Off	Enables the extended IDs mode.
GevCCP	0: OpenAccess, 1: ExclusiveAccess, 2: ControlAccess	—	Controls the device access privilege of an application.
GevPrimaryApplicationSocket	—	—	Returns the UDP source port of the primary application.
GevPrimaryApplicationIPAddress	—	—	Returns the address of the primary application.
GevMCPHostPort	0	0	Controls the port to which the device must send messages. Setting this value to 0 closes the message channel.
GevMCDA	0	0	Controls the destination IP address for the message channel.
GevMCSP	—	0	This feature indicates the source port for the message channel.

Item	Setting range	Default value	Description
GevStreamChannelSelector	0, 1, 2	0	Selects the stream channel to control.
GevSCPHostPort	0	0	Controls the port to which the device must send messages. Setting this value to 0 closes the message channel.
GevSCPSFireTestPacket	True, False	False	Sends a test packet. When this feature is set, the device will fire one test packet.
GevSCPSDoNotFragment	True, False	False	The state of this feature is copied into the "do not fragment" bit of IP header of each stream packet. It can be used by the application to prevent IP fragmentation of packets on the stream channel.
GevSCSPacketSize	1476~16366	—	This GigE Vision specific feature corresponds to DeviceStreamChannelPacketSize and should be kept in sync with it. It specifies the stream packet size, in bytes, to send on the selected channel for a GVSP transmitter or specifies the maximum packet size supported by a GVSP receiver.
GevSCPD	0~4294967295	0	Controls the delay (in GEV timestamp counter unit) to insert between each packet for this stream channel. This can be used as a crude flow-control mechanism if the application or the network infrastructure cannot keep up with the packets coming from the device.
GevSCDA	—	—	Controls the destination IP address of the selected stream channel to which a GVSP transmitter must send data stream or the destination IP address from which a GVSP receiver may receive data stream.
GevSCSP	—	—	Indicates the source port of the stream channel.

Item	Setting range	Default value	Description
q) PulseGenerator			
Configure pulse generator settings.			
ClockPreScaler	1~4096	165	Set the division value for the prescaler (12 bit) using PixelClock as the base clock.
PulseGeneratorClock (MHz)	0.0181274~74.25	0.45	Set the clock used for the pulse generator. This value is calculated using the [ClockPreScaler] value as a base.
PulseGeneratorSelector	0: PulseGenerator0, 1: PulseGenerator1, 2: PulseGenerator2, 3: PulseGenerator3	PulseGenerator0	Select the pulse generator.
PulseGeneratorLength	1~1048575	30000	Set the maximum count-up value as a clock count.
PulseGeneratorLengthMs	$1 / \text{PulseGeneratorClock (MHz)} \sim 1048575 / \text{PulseGeneratorClock (MHz)}$	66.6667	Set the maximum count-up value in milliseconds. This value is calculated using the [PulseGeneratorLength] value as a base. The setting range varies depending on the [ClockPreScaler] value.
PulseGeneratorFrequency	$\text{PulseGeneratorClock (MHz)} \div 1048575 \times 1000000 \sim \text{PulseGeneratorClock (MHz)} \times 1000000$		Set the maximum count-up value as a frequency. This value is calculated using the [PulseGeneratorLength] value as a base.
PulseGeneratorStartPoint	0 ~ 1048574	0	Set the start point of the High interval as a clock count. When the counter reaches this value, the output will be 1.
PulseGeneratorStartPointMs	$0 \sim 1048575 / \text{PulseGeneratorClock (MHz)}$	0	Set the start point of the High interval in milliseconds. When the counter reaches this value, the output will be 1. The setting range varies depending on the [ClockPreScaler] value.
PulseGeneratorEndPoint	1 ~ 1048575	15000	Set the start point of the Low interval as a clock count. When the counter reaches this value, the output will be 0.
PulseGeneratorEndPointMs	$1 / \text{PulseGeneratorClock (MHz)} \sim 1048575 / \text{PulseGeneratorClock (MHz)}$		Set the start point of the Low interval in milliseconds. When the counter reaches this value, the output will be 0. The setting range varies depending on the [ClockPreScaler] value.
PulseGeneratorPulseWidth	—	33.3333	Display the High interval width of the pulse in milliseconds. The duration between the Start Point and End Point is calculated. The setting range varies depending on the [ClockPreScaler] value.
PulseGeneratorRepeatCount	0 ~ 255	0	Set the repeat count for the counter. When this is set to [0], a free counter is enabled with no repeat limit.
PulseGeneratorClearActivation	0: Off, 1: RisingEdge, 2: FallingEdge, 3: LevelHigh, 4: LevelLow	Off	Set the clear signal condition for the count clear input of the pulse generator.
PulseGeneratorClearSource	—	—	Set the clear signal condition for the count clear input of the pulse generator. [Setting range] 1:AcquisitionActive - Source0, 45:AcquisitionActive - Source1, 57:AcquisitionActive - Source2 2:FrameActive - Source0, 46:FrameActive - Source1, 58:FrameActive - Source2 4:ExposureActive - Source0, 48:ExposureActive - Source1, 60:ExposureActive - Source2 5:FVAL - Source0, 49:FVAL - Source1, 61:FVAL - Source2 6:LVAL - Source0, 50:LVAL - Source1, 62:LVAL - Source2 43:AcquisitionTriggerWait - Source0, 51:AcquisitionTriggerWait - Source1, 63:AcquisitionTriggerWait - Source2 44:FrameTriggerWait - Source0, 52:FrameTriggerWait - Source1, 64:FrameTriggerWait - Source2 7:PulseGenerator0, 8:PulseGenerator1, 9:PulseGenerator2, 10:PulseGenerator3 11:UserOutput0, 12:UserOutput1, 13:UserOutput2, 14:UserOutput3 23:Line4 TTL In1 24:Line5 Opt In1 25:Line6 Opt In2 29:Line10 TTL In2 36:Nand0 Out 37:Nand1 Out
PulseGeneratorClearSyncMode	0:AsyncMode, 1:SyncMode	AsyncMode	Select the sync mode for the count clear input signal.

Item	Setting range	Default value	Description
r) Shading			
Configure shading correction settings.			
ShadingCorrectionMode	0: FlatShading, 1: ColorShading	FlatShading	Select the shading correction method.
ShadingMode	0: Off, 1: User1, 2: User2, 3: User3	Off	Set the area to which to save shading correction data. When this is set to [Off], shading correction data is not saved.
PerformShadingCalibration	—	—	Execute shading correction. This command can not be executed under the following conditions. <ul style="list-style-type: none"> When no image is output. Outputting TestPattern. When the ROI setting is under the following conditions. (Width or Height are less than 128) Shading Mode is Off.
ShadingDetectResult	—	—	Display the shading correction results. 0: Idle 1: Succeeded (Shading calibration was Succeeded.) 2: Error1 (Image was too bright.) 3: Error2 (Image was too dark.) 4: Error3 (Could not calibrated.) 5: Error4 (Correction Limit.)
s) Correction			
Correct variations due to sensors and lenses.			
VideoProcessBypassMode	0: Off, 1: On	Off	Enable/disable VideoProcessBypass mode.
t) BlemishControl			
Configure settings for JAI white blemish correction.			
BlemishEnable	True, False	True	Enable/disable blemish correction.
BlemishDetect	—	—	Execute blemish detection. This command can not be executed under the following conditions. <ul style="list-style-type: none"> When no image is output Outputting TestPattern In Sequencer mode In MultiRoi mode In single ROI mode
BlemishDetectThreshold	1 ~ 100	10	Set the blemish detection threshold.
BlemishStore	—	—	Stores the Blemish data that to be entered by BlemishCompensationPositionX and BlemishCompensationPositionY.
BlemishCompensationIndex	1 ~ 1736	1	Select the index for the target blemish coordinates (BlemishDataPosition X/Y).
BlemishCompensationPositionX	-1 ~ 2047	—	Display the X coordinate (horizontal pixel position) of the target blemish selected in [BlemishCompensationIndex]. You can also manually enter the X coordinate of the blemish you want to correct.
BlemishCompensationPositionY	-1 ~ 1535	—	Display the Y coordinate (vertical pixel position) of the target blemish selected in [BlemishCompensationIndex]. You can also manually enter the Y coordinate of the blemish you want to correct.
BlemishCompensationDataClear	—	—	Delete detected or specified blemish information selected in [BlemishCompensationIndex].
BlemishCompensationNumber	0 ~ 1736	0	Display the number of target blemishes.
u) MultiROIControl			
Configure settings for Multi ROI.			
MultiRoiMode	0: Off, 1: On	Off	Enable/disable Multi Roi.
MultiRoiIndex	0 ~ 7	0 ~ 7	Select the index for the Multi Roi mode.
MultiRoiWidth	—	—	Set the width for the selected Multi Roi index.
MultiRoiHeight	—	—	Set the height for the selected Multi Roi index.
MultiRoiOffsetX	—	—	Set the horizontal offset for the selected Multi Roi index.
MultiRoiOffsetY	—	—	Set the vertical offset for the selected Multi Roi index.
MultiRoiHorizontalEnableNumber	1 ~ 8	—	Set the maximum number of valid horizontal index numbers.
MultiRoiVerticalEnableNumber	1 ~ 8	—	Set the maximum number of valid vertical index numbers.

Miscellaneous

Troubleshooting

Check the following before requesting help. If the problem persists, contact your local JAI distributor.

■ Power supply and connections

Problem	Cause and solution
The POWER/TRIG LED remains lit amber and does not turn green, even after power is supplied to the camera.	Camera initialization may not be complete due to lack of a network connection. Check the 12-pin power cable connection.

■ Image display

Problem	Cause and solution
Gradation in dark areas is not noticeable.	Use the gamma function to correct the display. As the light-emitting properties of the monitor are not linear, the entire image may be darker or the gradation in the dark areas may be less noticeable when camera outputs are displayed without processing. Using the gamma function performs correction to produce a display that is close to linear. For details, see "Gamma Function".

■ Settings and operations

Problem	Cause and solution
Settings cannot be saved to user memory.	You cannot save to user memory while images are being acquired by the camera. Stop image acquisition before performing the save operation.
I want to restore the factory default settings.	Load [Default] under [User Set Selector] in the [Feature Properties] tab to restore the factory default settings.

Specifications

Item		FSFE-3200T-10GE (Flex-Eye)	
Scanning system		Progressive scan	
Synchronization		Internal	
Interface		10GBase-T, 5GBase-T, 2.5GBase-T, 1000Base-T (GigE Vision 2.0), IEEE 802.3af	
Image sensor		3CMOS (Bayer color or Monochrome)	
image size (effective image)		1/1.8-inch 7.12mm(H) x 5.33mm(V) : 8.89mm(diagonal)	
Pixel size		3.45 μm (H) x 3.45 μm (V)	
Effective image pixel (Image sensor)		2048(H) x 1536(V)	
Acquisition Frame Rate (max)	8bit	Mono8	107.2 fps
		BayerRG8	
Digital image output format	Full		2048(H) x 1536(V)
	ROI	Width	16 ~ 2048 pixels 16 pixels/step
		Offset X	0 ~ 2032 pixels 16 pixels/step
		Height	8 ~ 1536 lines 4 lines/step
		Offset Y	0 ~ 1528 lines 4 lines/step
	Binning (H)	1	2048(H)
		2	1024(H)
	Binning (V)	1	1536(V)
		2	768(V)
	Pixel Format		Bayer color BayerRG8, BayerRG10, BayerRG12, BayerRG10Packed, BayerRG12Packed Monochrome Mono8, Mono10, Mono10Packed, Mono12, Mono12Packed
Acquisition Mode		Continuous / SingleFrame / MultiFrame (1 ~ 65535)	
Trigger Selector	Acquisition	AcquisitionStart / AcquisitionStop	
	Exposure	FrameStart	
	Transfer	AcquisitionTransferStart (delayed readout)	
Opto filter		Off(Default), 10 μs , 100 μs , 500 μs , 1ms, 5ms, 10ms	
Trigger overlap		Available	
Trigger input signals		Low, High, Software, PulseGenerator0-3, UserOutput0-3, Line5-Opt In 1, Line6-Opt In 2, Line4-TTL In 1, Line10-TTL In 2, NAND 0 Out, NAND 1 Out	
Exposure Mode	Timed	14.73 μs^* (min) ~ 8 s (max) ❖ Performance verified for up to 1 second.	
	Trigger Width	14.73 μs^* (min) ~ ∞ s (max) ❖ Performance verified for up to 1 second.	
Auto Exposure (Exposure Auto)		Off / Continuous / Once	
Auto exposure response speed (AGC/ASC Control Speed)		1 ~ 8	
Video send mode		NormalMode, TriggerSequencerMode, CommandSequencerMode, MultiRoiMode	
Digital I/O		LineSelector DC IN/TRIG connector (12-pin round), AUX connector (10-pin) : GPIO IN / GPIO OUT	
Black Level adjustment	Default level		8LSB@8bit
	Video level adjustment range		DigitalAll : -133 ~ +255 LSB @12bit DigitalRed : -64 ~ +64 LSB @12bit DigitalBlue : -64 ~ +64 LSB @12bit
	Resolution adjustment		1LSB@12bit

*) Refer to Exposure Mode section for details.

Gain adjustment	Manual adjustment range		AnalogAll : 0dB ~ 24dB DigitalRed : -7dB ~ 15dB DigitalBlue : -7dB ~ 15dB
	adjustment Auto gain		Off, Continuous, Once
White balance	WhiteBalanceGain		DigitalRed, DigitalBlue : -7dB ~ 15dB
	BalanceWhiteAuto		Off, Continuous, Once, Preset3200K, Preset5000K, Preset6500K, Preset7500K
	Photometry area		16 (4 x 4) Area
	Adjustment range		3000K ~ 9000K
Blemish correction	Detection		Detect white blemishes using threshold values (100 steps available) (black blemish correction performed only at factory)
	Correction		Interpolation using adjacent pixels (continuous blemishes not corrected)
	Correctable pixels		1736 pixels / sensor
ALC			Video level adjusted automatically using AGC and ASC
Gamma			0.45,0.5,0.55,0.6,0.65,0.75,0.8,0.9,1.0 (9 steps available)
LUT			OFF : $\gamma = 1.0$, ON = 257 points can be set
Vibration resistance			3G (20 Hz ~ 200 Hz X-Y-Z direction)
Impact resistance			50G
Power supply	12-pin Connector	Input range	DC + 10 V ~ + 25 V (Via input terminal)
		Consumption	11.6 W (typ.) (at 12 V input, default setting, 25 °C environment) 15.3 W (max.)
Lens mount			C-mount Lens mount protrusion length of 4 mm or less is supported
Flange back			17.526, tolerance: 0 mm to -0.05 mm
Optical filter			IR cut filter (Sensor 0/Stream 0)
Verified performance temperature / humidity			- 5°C ~ + 45°C / 20% ~ 80% (non-condensing)
Storage temperature / humidity			- 25°C ~ + 60°C / 20% ~ 80% (non-condensing)
Regulations			CE(EN 55032:2015, EN 55035:2017), FCC part 15 class B, RoHS, WEEE
Dimensions (housing)			62 × 62 × 86.5mm (WHD) (excluding mount protrusions)
Weight			270 g

Package contentsCamera

- body (1)
- Sensor protection cap (1)
- Dear Customer (sheet) (1)

Optional accessories (not supplied)

- MP-41 tripod mount

Design and specifications are subject to change without notice.

Approximately 30 minutes of warm-up are required to achieve these specifications.

Caution

About the verified performance temperature Make sure the following temperature conditions are met when operating the unit.

- 1) The camera's internal temperature sensor detects temperatures of 101°C or less during operation.

If the above temperature conditions are exceeded, take measures to dissipate heat according to your installation environment and conditions.

Maximum Frame Rate Reference

[Theoretical value]

[When the maximum packet length is 1476 bytes and the packet delay is 0 ns]

10Gbps	Full pixels	PixelFormat	Framerate
	2048 x 1536	BayerRG8 / Mono8	107.2 fps
2048 x 1536	BayerRG10Packed/Mono10Packed BayerRG12Packed/Mono12Packed	71.4 fps	
2048 x 1536	BayerRG10 / Mono10 BayerRG12 / Mono12	53.6 fps	

5Gbps	Full pixels	PixelFormat	Framerate
	2048 x 1536	BayerRG8 / Mono8	56.3 fps
2048 x 1536	BayerRG10Packed/Mono10Packed BayerRG12Packed/Mono12Packed	37.5 fps	
2048 x 1536	BayerRG10 / Mono10 BayerRG12 / Mono12	28.1 fps	

2.5Gbps	Full pixels	PixelFormat	Framerate
	2048 x 1536	BayerRG8 / Mono8	27.8 fps
2048 x 1536	BayerRG10Packed/Mono10Packed BayerRG12Packed/Mono12Packed	18.5 fps	
2048 x 1536	BayerRG10 / Mono10 BayerRG12 / Mono12	13.9 fps	

1Gbps	Full pixels	PixelFormat	Framerate
	2048 x 1536	BayerRG8 / Mono8	11.4 fps
2048 x 1536	BayerRG10Packed/Mono10Packed BayerRG12Packed/Mono12Packed	7.6 fps	
2048 x 1536	BayerRG10 / Mono10 BayerRG12 / Mono12	5.7 fps	

Dimensions

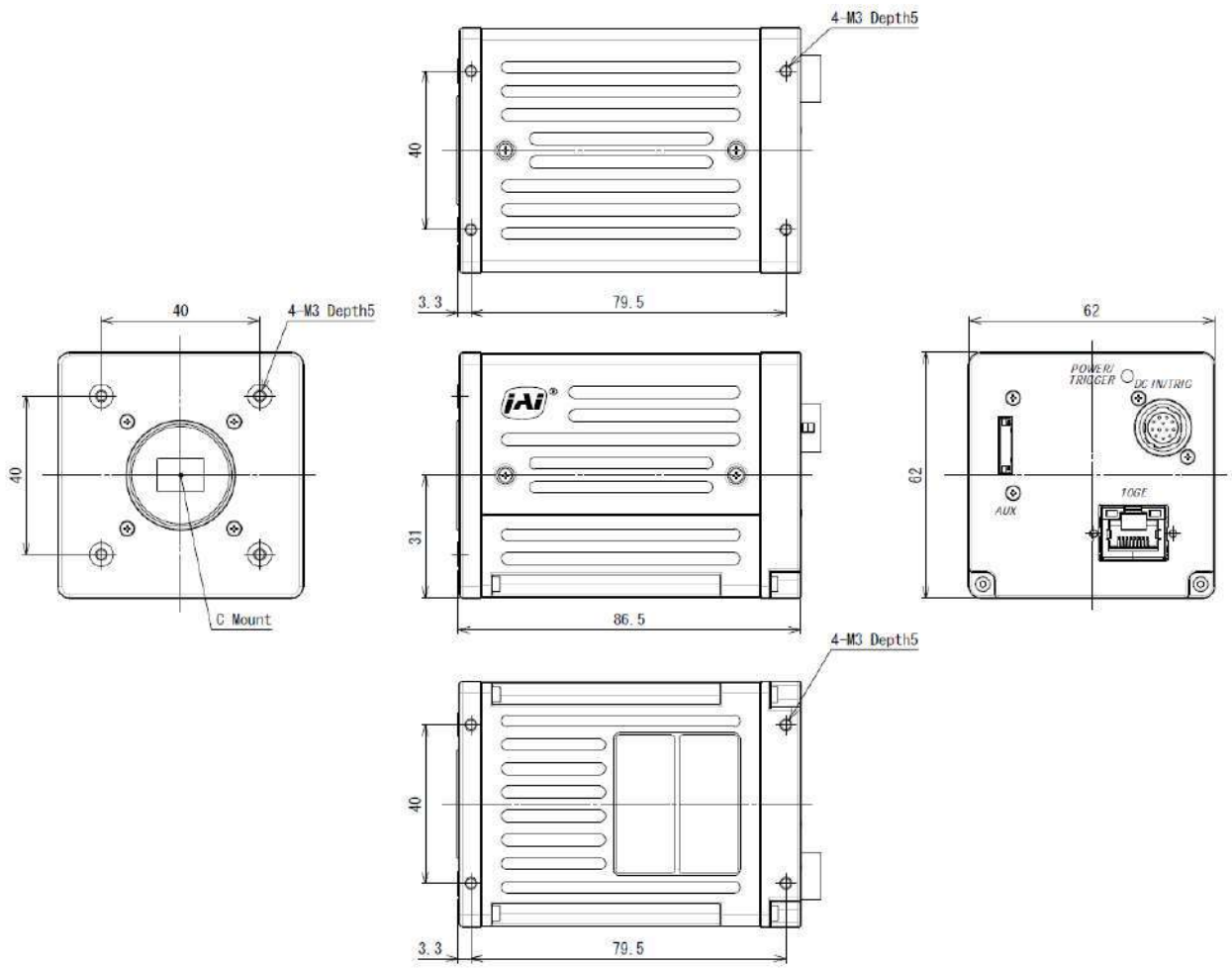

Dimensional tolerance: $\pm 0.3\text{mm}$
Unit: mm

Comparison of the Decibel Display and Multiplier Display

Decibels [db]	Multipliers [x]	Remarks
-7	0.447	
-6	0.501	
-5	0.562	
-4	0.631	
-3	0.708	
-2	0.794	
-1	0.891	
0	1	
1	1.122	
2	1.259	
3	1.413	
4	1.585	
5	1.778	
6	1.995	
7	2.239	
8	2.512	
9	2.818	
10	3.162	
11	3.548	
12	3.981	
13	4.467	
14	5.012	
15	5.623	
16	6.31	
17	7.079	
18	7.943	
19	8.913	
20	10	
21	11.22	
22	12.589	
23	14.125	
24	15.849	
25	17.783	
26	19.953	
27	22.387	
28	25.119	
29	28.184	
30	31.623	
31	35.481	
32	39.811	
33	44.668	
34	50.119	
35	56.234	
36	63.096	

User's Record

Camera type: FS-3200T-10GE (Flex-Eye)

Revision:

Serial No:

Firmware version:

For camera revision history, please contact your local JAI distributor.

Trademarks

- Microsoft and Windows are trademarks or registered trademarks of Microsoft Corporation in the United States and other countries.
- Intel and Intel Core are trademarks of Intel Corporation in the United States and other countries.

Other system and product names described in this document are trademarks or registered trademarks of their respective owners. The ™ and ® symbols are not used in this document.

Index

0-9

12-pin round	10
--------------	----

A

Acquisition	37
Adjusting the Black Level	22
Adjusting the Gain	22

B

Binning Function	59
Blemish Compensation	57

C

Camera locking screw holes	13
Chunk Data Function	64
C-mount	15
Connecting Devices	15
Counter And Timer Control	68

D

DC IN	10
DC IN/TRIG connector	10
Digital Input/Output Settings	42
Dimensions	89

E

Exposure Mode	38
---------------	----

F

Factory default settings	23
Feature Properties	70
Frame rate	48
Frame rate reference	87

G

Gamma Function	55
GPIO	42

I

Installing the Software	14
-------------------------	----

L

LED	8
Lens	15
Lens mount	15
Lookup Table	56
LUT	56

P

Parts Identification	8
Pixel format	35
POWER/TRIG LED	8

R

Regional Scanning Function	60
RJ-45 connector	9
ROI	60

S

Saving the Settings	23
Sequencer Function	62
Setting List	70
Shading Correction	58
Specifications	85
Spectral Response	88

T

Trigger Control	40
Trigger Selector	40
Troubleshooting	84

U

User memory	23
-------------	----

V

Verifying the Connection between the Camera and PC	17
Video Process Bypass Mode	36

