

Basler IP Fixed Box Cameras



User's Manual for BIP2-XXXXc and BIP2-XXXXc-dn Models

Document Number: AW000972

Version: 16 Language: 000 (English)

Release Date: 27 January 2020

Contacting Basler Support Worldwide

Europe, Middle East, Africa

Basler AG
An der Strusbek 60–62
22926 Ahrensburg
Germany

Tel. +49 4102 463 515
Fax +49 4102 463 599

support.europe@baslerweb.com

The Americas

Basler, Inc.
855 Springdale Drive, Suite 203
Exton, PA 19341
USA

Tel. +1 610 280 0171
Fax +1 610 280 7608

support.usa@baslerweb.com

Asia-Pacific

Basler Asia Pte. Ltd.
35 Marsiling Industrial Estate Road 3
#05–06
Singapore 739257

Tel. +65 6367 1355
Fax +65 6367 1255

support.asia@baslerweb.com

www.baslerweb.com

All material in this publication is subject to change without notice and is copyright Basler AG.

Table of Contents

1	Introduction	1
1.1	About this Document	1
1.2	Precautions	2
1.3	Overview	4
2	Accessing the Camera	6
3	Configuring the Camera	7
3.1	Introduction	7
3.2	Accessing the Configuration Tools and Camera Parameters	10
3.3	Image Control Parameters	13
3.4	Streaming Parameters	20
3.5	Motion Detection Parameters	41
3.6	Alarm Handling Parameters	43
3.7	Live Recording Parameters	51
3.8	Network Parameters	54
3.9	Input / Output Parameters	58
3.10	User Parameters	66
3.11	System Parameters	72
4	Factory Default Button	81
5	The Terminal Connector	82
6	Day/Night Functionality	88
6.1	Introduction	88
6.2	IR-Cut Filter Control Options	91
7	Real-Time Trigger Functionality	95
7.1	Introduction	95
7.2	Enabling and Using Real-Time Triggering	98
7.3	Real-Time Triggering Impact on Streams	99
8	Technical Specifications	100
8.1	BIP2-1300c/-dn and BIP2-1600c/-dn	100
8.2	BIP2-1280c/-dn, BIP2-1920c/-dn, and BIP2-2500c/-dn	102
8.3	BIP2-1920-30c	104
8.4	Dimensions	106
8.5	Stress Test Results	108
	Appendix A Software License Information	109

Revision History 11

Index 115

1 Introduction

1.1 About this Document

Applicability

This document applies to cameras that have the designation "BIP2" as part of their model name. See the specification tables in Section 8 on [page 100](#) for a complete list of the camera models covered by this document.

This document is intended for administrative users of the camera. Previous experience with networking will be a great help when using this document.

This document assumes that you have already followed the instructions in the *Basler IP Fixed Box Camera Installation Guide* (AW000975) to install your camera.

You can download the latest version of this manual along with versions in other languages from the Downloads section of the Basler website: www.baslerweb.com/manuals

Firmware

This document applies to cameras with version 3.15.0 firmware. Cameras with different versions of the firmware may have different features than those described here.

To ensure that your camera's functionality is up to date, you should periodically check the Downloads section of the Basler website to see if a firmware update file is available. The website address is: www.baslerweb.com/firmware

You can view the current firmware version of a camera and apply a firmware update in two different ways:

- By using the Basler IP Camera Web Client.

After you access a camera using the client (as described in Section 3.2 on [page 10](#)), you can use the **Info** tab in the **System** parameters group to view the current firmware version of the camera (see Section 3.11.1 on [page 72](#)).

If you need to update the firmware, you can use the **Start Firmware Update** button on the **Management** tab in the **System** parameters group to apply a new firmware file to the camera (as described in Section 3.11.3 on [page 74](#)).

- By using the Basler IP Camera Finder software (version 1.7 or higher).

An advantage of the BIP Finder software is that it will let you view the firmware versions on several cameras at once, and it will let you apply a new firmware file to several cameras simultaneously.

Refer to the BIP Finder help file for information about how to view firmware versions and how to update the camera firmware (the help file is a separate file that is included along with the BIP Finder software).

The BIP Finder software is available in the Downloads section of the Basler website: www.baslerweb.com/BIP_finder

1.2 Precautions



WARNING

The camera is not designed for unprotected use in an explosive atmosphere.

If you use the camera in an explosive atmosphere, it must be enclosed within an appropriate environmental housing



CAUTION

Electrical Shock Hazard

Touching the camera's internal components may result in an electrical shock.

Do not open the camera housing. The housing contains no user serviceable parts.

NOTICE

The camera is not designed for unprotected outdoor use and can be damaged by excessively damp or wet conditions.

If you are using the camera outdoors, you should mount the camera in a weatherproof housing.

NOTICE

Every time you replace the plastic cap, a lens or a lens adapter, make sure that the camera is pointing down.

Never apply compressed air to the camera. This can easily contaminate optical components, particularly the sensor.

NOTICE

Lenses that reach too far into the lens mount can damage the IR-cut filter.

For more information, see the dimension drawings in Chapter 8 on [page 100](#).

WEEE Directive

The European Union has enacted Directive 2002/96/EC on Waste Electrical and Electronic Equipment (the WEEE Directive). This directive is only applicable in European Union member states.

All Basler IP Cameras have been manufactured after the 31st of August 2005.

1.3 Overview

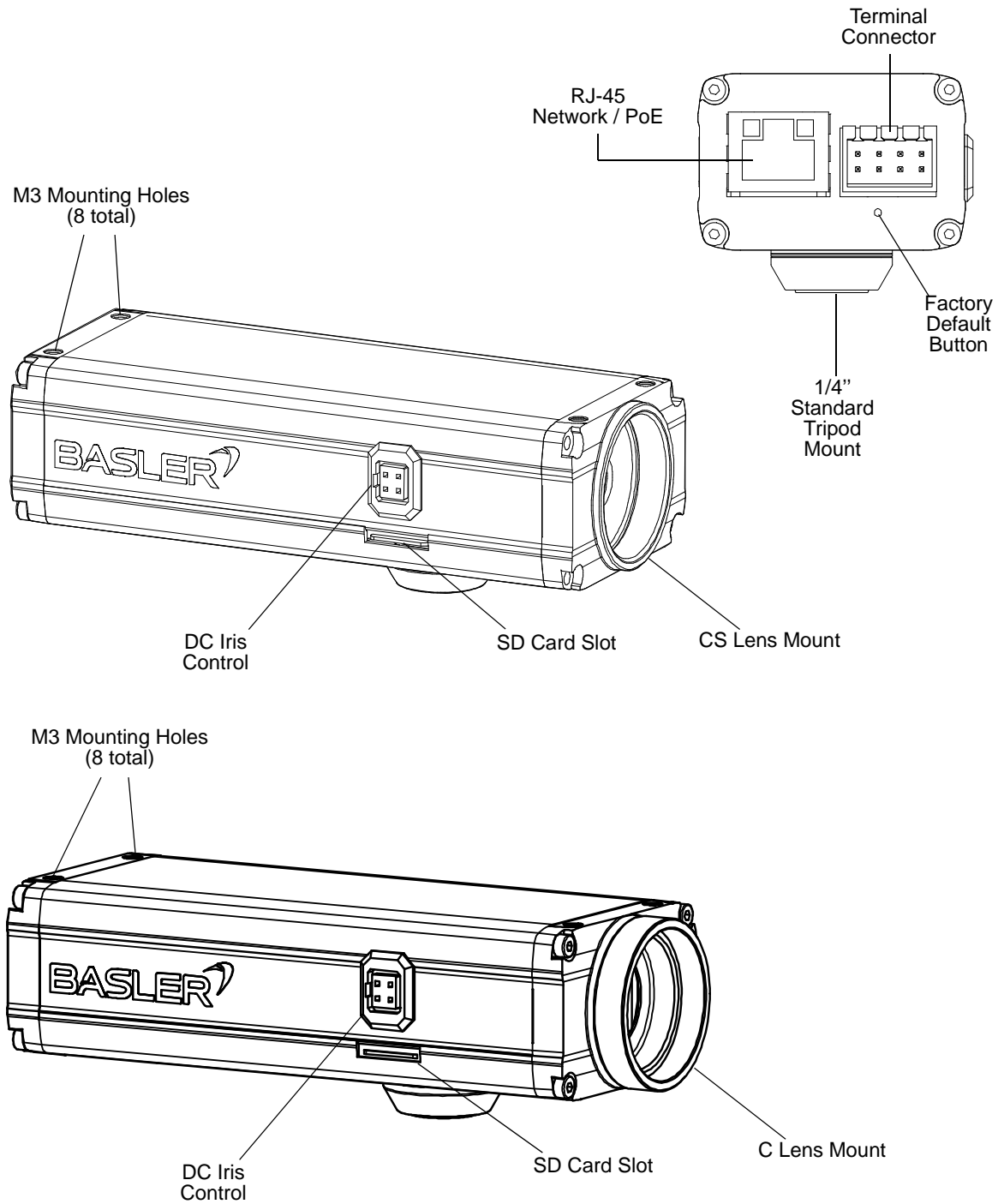

Fig. 1: Camera Connections for C-Mount and CS-Mount Camera Models

- **RJ-45 Network / PoE** - Provides a 10/100 Ethernet connection and can be used to connect Power over Ethernet (IEEE 802.3af) to the camera.
- **Terminal Connector** - Provides connections for an alternate camera power input, connections for the camera's I/O ports, and connections for a standard RS-485 serial port that can be used to control an external device. See Section 5 on [page 82](#) for detailed information about the terminal connector.
- **DC Iris Control** - Provides a connection for a DC auto iris.
- **Lens Mount** - Provides a point to mount a lens on the camera (a 5 mm extension ring is required if a C-mount lens is used; except for BIP2-1920-30c which comes with a C-mount adapter that holds the IR-cut filter).
- **Factory Default Button** - Used to return the camera to factory default settings (see Section 4 on [page 81](#) for details).
- **SD Card Slot** - Can hold a microSD or a microSDHC card. The card can be used to store alarm images or the contents of the alarm buffers. See [page 50](#) and [page 52](#) for details. (An SD card is not included with the camera.)

The following file system formats are supported:

- FAT16 (VFAT)
- FAT32 (VFAT)

2 Accessing the Camera

The following instructions assume that you have used the *Basler IP Fixed Box Camera Installation Guide* (AW000975) to install your camera and that you know either the IP address or the host name of your camera. (If you don't know the IP address, you can find it using the Basler BIP Finder software as described in the installation guide.)

Your camera can be accessed from most standard operating systems using a web browser. The recommended browser is the Windows™ Internet Explorer 8.0 or higher.

To Access the Camera From a Web Browser

1. Start your web browser.
2. If you know the IP address of your camera, type the IP address into the address field of your browser and press the Enter key. For example: `http://172.17.1.44`
If you know the host name of your camera and if your network has a properly configured domain name server, type the host name into the address field of your browser and press the Enter key. For example, for a camera with a host name of `Basler-12345678` enter: `http://basler-12345678`
3. Your browser will connect to the camera's web server and the Basler IP Camera Web Client will be displayed. Assuming that the camera is set to the defaults, a live MJPEG video stream will be displayed in the **Live Stream 0** tab as shown below.

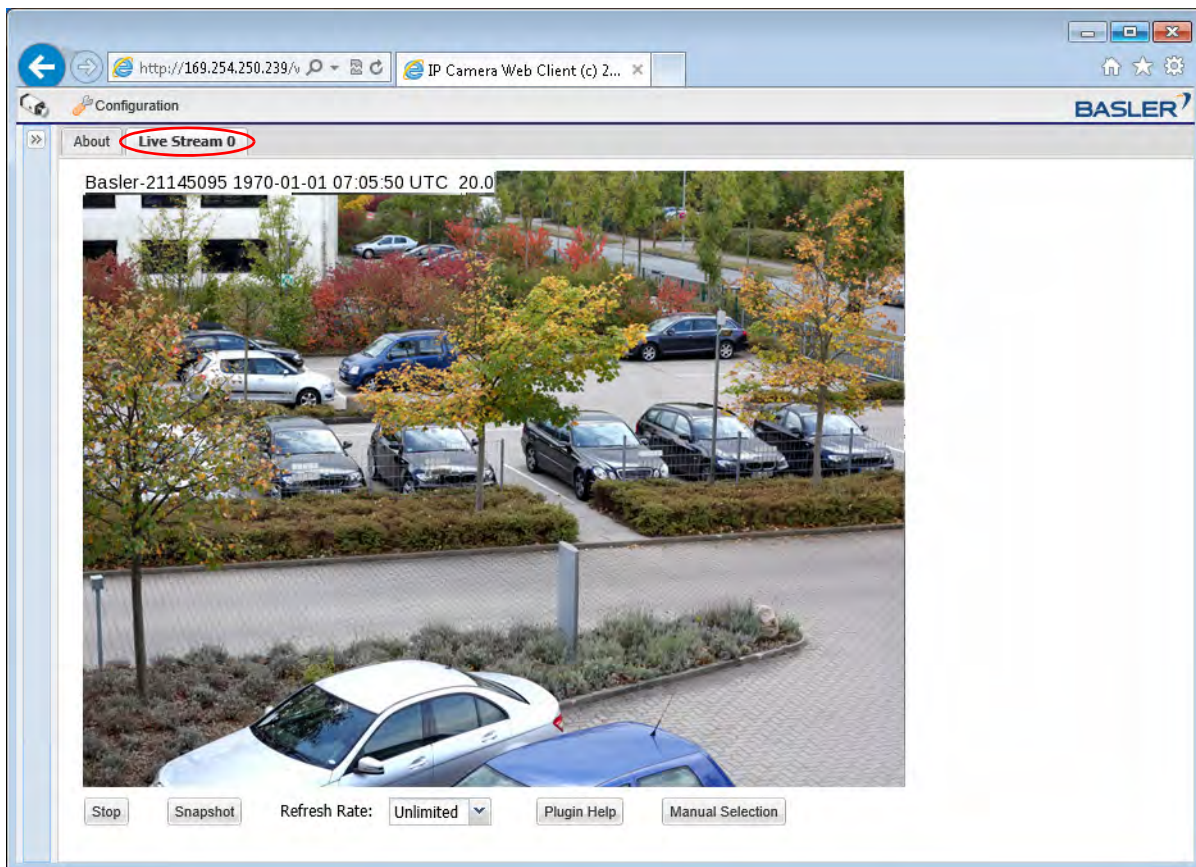

3 Configuring the Camera

This section describes how to configure your camera. It is intended to be used by administrators who have full access rights to the camera.

3.1 Introduction

When adjusting the parameters used to configure the camera, it helps to have an overview of the camera's functionality in mind. Figure 2 on [page 9](#) shows a block diagram of the camera outlining the basic functional units in the camera and shows how they are related.

As shown in Figure 2, the camera includes a sensor that captures images. The images are passed from the sensor to a microprocessor. In the microprocessor, a variety of tasks are performed on the captured images, such as white balancing and motion detection. Note that there is a path from the microprocessor to the imaging sensor. This path allows the processor to control how the sensor will capture images (e.g., the size of the image area captured and the image capture rate).

Once images are captured and processed, they are passed to the video encoders in the camera. Depending on the camera model, your camera has two or four encoders. The encoders are designated as the stream 0 encoder, stream 1 encoder, and so on. Each encoder can be configured separately. The stream 0 encoder is always enabled and can be configured to use JPEG, MPEG4, H.264 Base Profile, or H.264 High Profile video encoding. Camera models with a global shutter can also be configured to use JPEG (RT triggered) or YUV (RT triggered) video encoding. The other encoders can be enabled or disabled by the user, and offer the same encoding modes as the stream 0 encoder.

Each encoder feeds a live buffer and an alarm buffer. As shown in the drawing, multiple network devices (usually computers) can access each encoder stream. A device can access the live buffer for a stream, the alarm buffer for a stream, or both. A device can also open multiple connections to the camera's streams (each connection is commonly referred to as a "network stream").

In essence, the camera can produce up to three differently configured video streams and each stream can be accessed by multiple network users.

Normal Operating Mode and Configuration Mode

As shown in Figure 2, there are groups of parameters that affect the functionality of the camera at various stages of its operation. You configure the camera by setting these parameters.

When the camera is in its "normal" operating mode, it captures images, processes them, encodes them, and streams them to external devices via the network connection. In normal mode, most of the camera's parameters can be changed, and a change to a parameter will have an immediate effect on the operation of the camera. If you take a look at the screenshot of the Basler IP Camera Web Client on [page 11](#), you will see a list of parameters groups on the left side, such as **Image**

Controls, Streaming, Motion Detection, Alarm Handling, etc. Except for the **Streaming** group, the parameters in each group can be adjusted while the camera is in normal mode.

The parameters in the **Streaming** group can only be adjusted when the camera is in "configuration" mode. When you open the **Streaming** parameters group in the web client, the camera will automatically be placed in the configuration mode. Any changes you make to the parameters in the **Streaming** group will not take effect until you close the group. The camera will apply any changes and will automatically return to normal mode when you close the **Streaming** group.



The camera will continue to capture and stream images normally while it is in configuration mode.

If you change the **Live Buffer Size** parameter setting or the **Alarm Buffer Size** parameter setting for any stream, the setting changes will be applied when you switch back to the normal mode and **all streams** will be stopped and restarted.

If you change the **Encoder Type** parameter setting, the **Output Scaling** parameter setting, the **AOI Width** parameter setting, or the **AOI Height** parameter setting for any one of the streams, the setting changes will be applied when you switch back to normal mode and that stream will be stopped and restarted.

(Keep in mind that if you change the sensor **AOI Width** and **AOI Height** settings to values that are smaller than the current stream **AOI Width** and **AOI Height** settings, the camera will automatically make the stream **AOI Width** and **AOI Height** settings smaller.)

Capture Frame Rate and Stream Frame Rate

An image that has been captured by the camera is commonly called a "frame", and the rate at which the camera captures images is referred to as the "frame rate". Normally, the camera will attempt to encode and stream frames at the same rate at which they are being captured by the imaging sensor.

Note that there is an easy way to determine the current rate at which an encoder is encoding and streaming images. If you simply add the \$fps\$ expression to the text overlay setup for the stream, the text overlay on the streamed images will display the current rate at which the images are being encoded and streamed. For example, if you added the \$fps\$ expression to the text overlay setup for encoder stream 0, the images in stream 0 would display the current rate in the text overlay. See Section 3.4.1 on [page 21](#) for more information about setting text overlays.

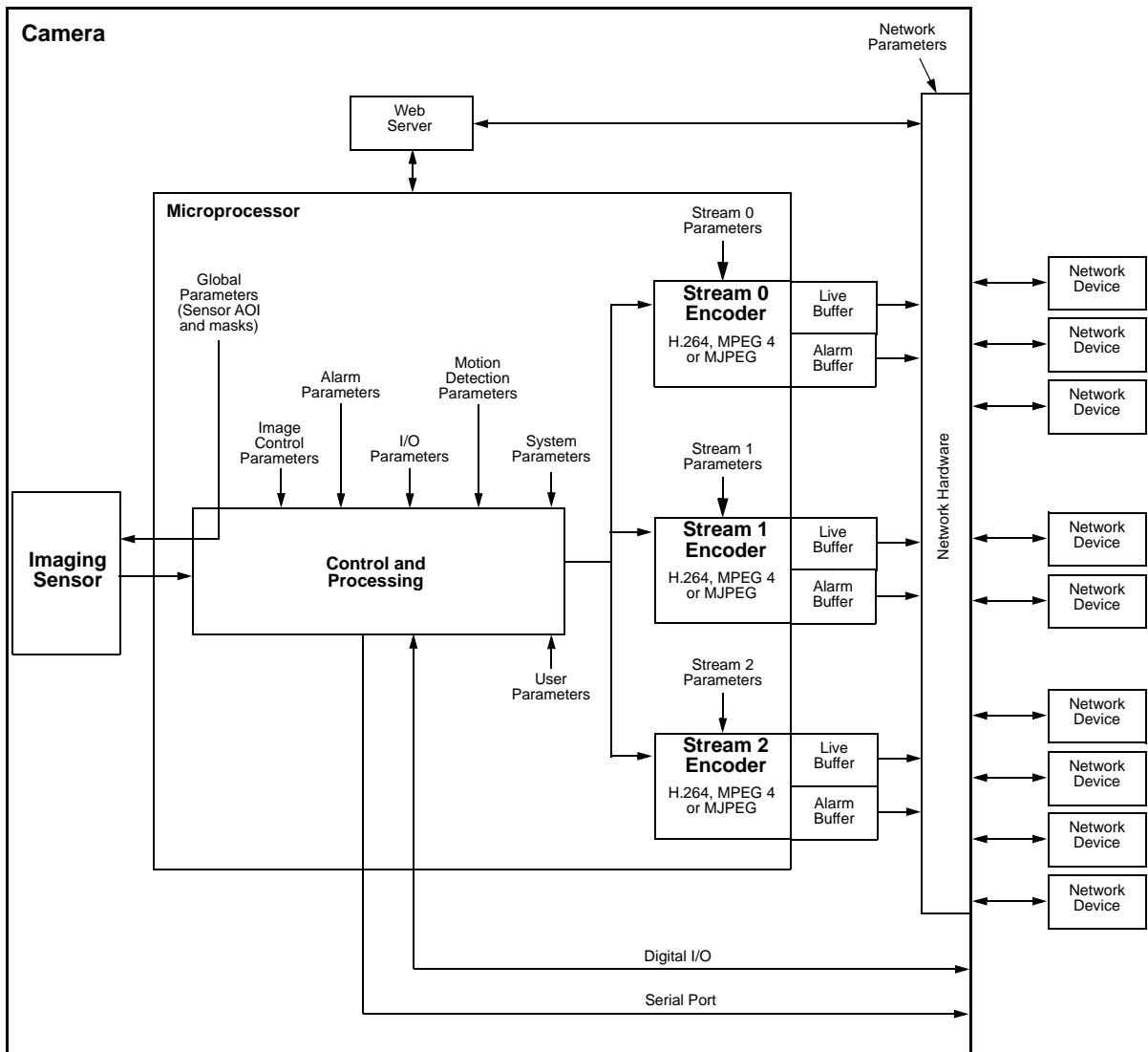
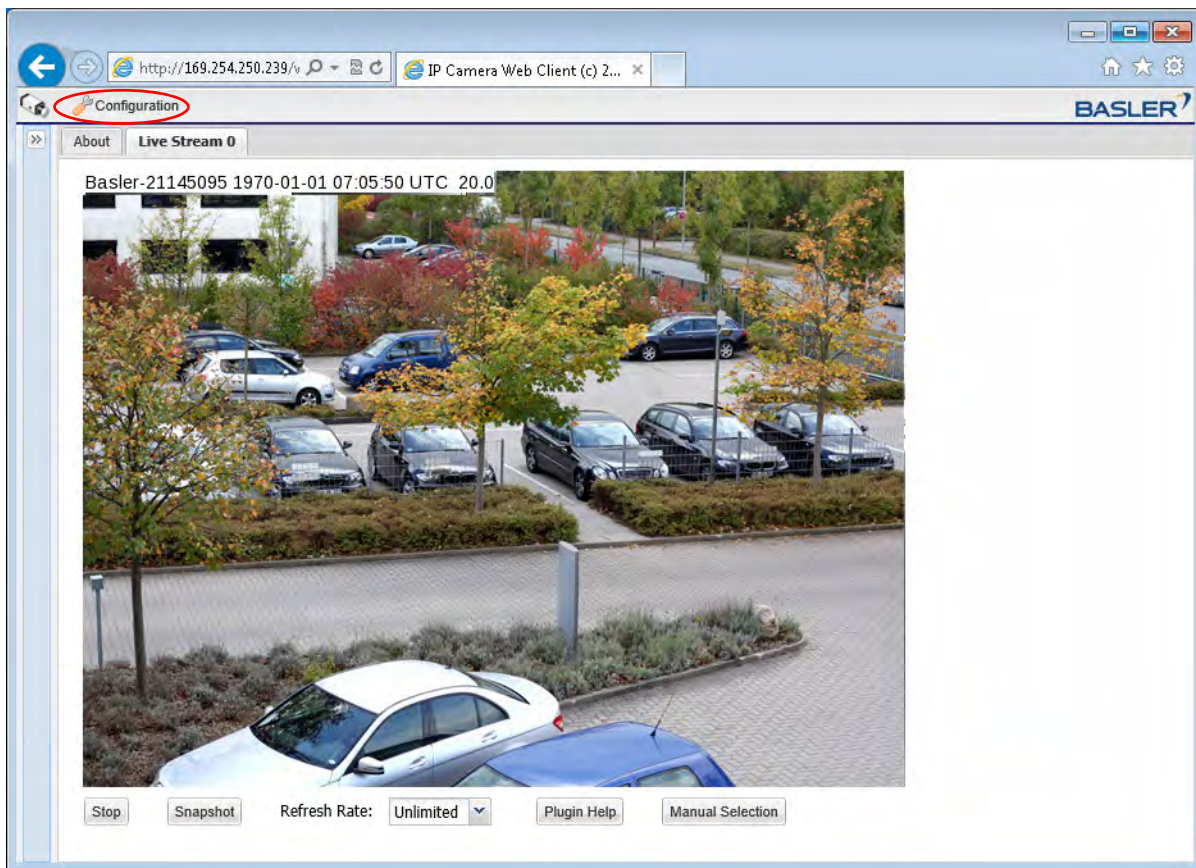

Fig. 2: Camera Block Diagram

3.2 Accessing the Configuration Tools and Camera Parameters

1. If you have not already done so, start your web browser and access the Basler IP Camera Web Client in your camera as described in Section 2 on [page 6](#).
2. When the Basler IP Camera Web Client opens as shown below, click the **Configuration** button on the left side of the Basler toolbar.



3. A **Camera Configuration** menu will open on the left side of the client as shown below. Notice that the parameters used to configure the camera appear in groups such as the **Image Controls** group and the **Streaming** group.

You can open a parameters group by clicking the **+** sign beside the group name.

By default, the camera is set so that video stream 0 is an MJPEG stream, and a **Live Stream 0** tab will appear in the client as shown below. A live video stream will appear in the tab.

If more than one video stream is enabled, there will be an additional **Live Stream** tab available for each enabled stream.

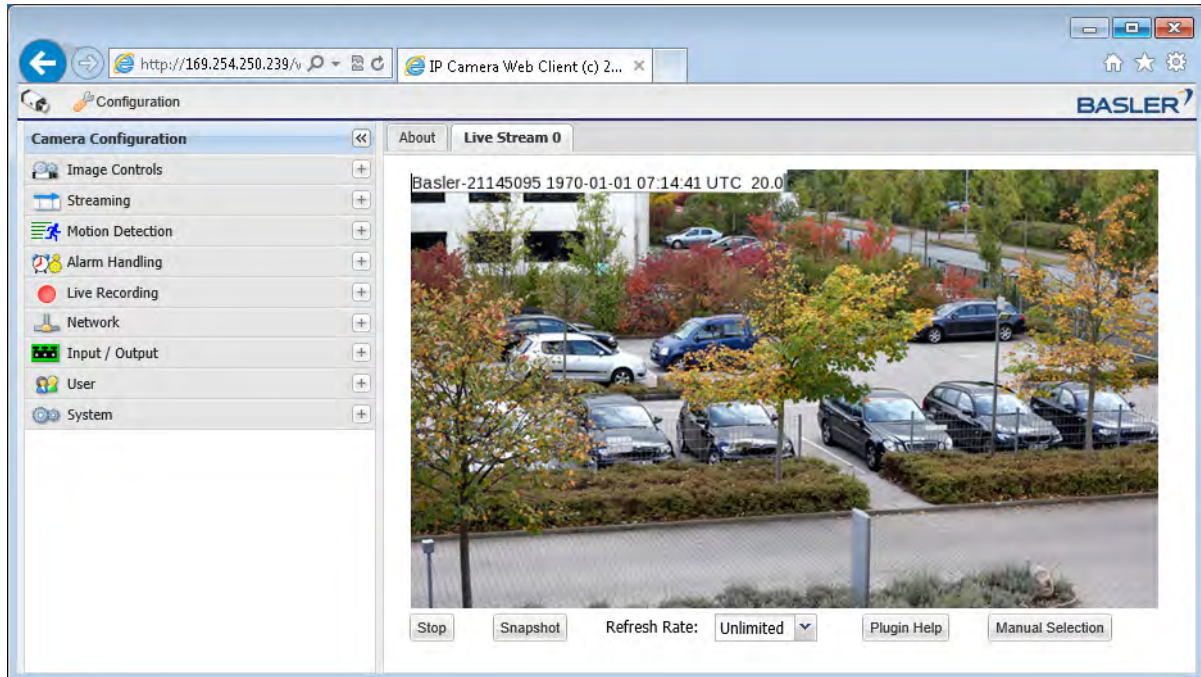

Depending on the type of web browser you are using and depending on how you set the stream settings, some or all of the following buttons and boxes will appear below the live stream:

Stop - Click the **Stop** button to stop live image streaming. (A **Start** button will appear, which will let you restart the live stream.)

Snapshot - Click the **Snapshot** button to capture a single image within a new browser window. The last available image in the live or the alarm buffer will be delivered. The **Snapshot** button is only available with JPEG video encoding.

Refresh Rate - The **Refresh Rate** box displays the rate at which the images displayed in the web client are refreshed. Use the button to change the refresh rate.

Note that changing the **Refresh Rate** setting will not change the rate at which the camera captures or streams images. The **Refresh Rate** setting only affects the rate at which images are displayed in the web client in your browser. Some browsers perform poorly when set to a high refresh rate. Opening and closing parameters groups or switching from one tab to another will work very slowly if the refresh rate is too high.

Plugin Help - Click the **Plugin Help** button to get information about installing the plugins needed to view live streams in your web browser.

Manual Selection - Click the **Manual Selection** button to zoom into or out of the streamed image by using the mouse wheel. You can also use the vertical and horizontal scroll bars around the streamed image to adjust the zoom section as necessary.

Fit to Window - Click the **Fit to Window** button to fit the image to the window.

Note that the **Manual Selection** and **Fit to Window** button is a toggle button that changes its functionality depending on the current state.

3.3 Image Control Parameters

The parameters in the **Image Controls** group control the quality of the images captured by the camera's imaging sensor.

3.3.1 Exposure Tab

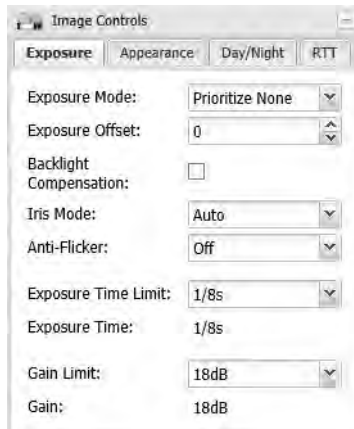

Exposure Mode - Sets the camera's exposure mode.

- **Prioritize None** = Automatic exposure time control and automatic gain control are both enabled. The camera will automatically adjust both the exposure time and the gain to maintain good overall image quality as lighting conditions change. Neither the exposure time adjustment nor the gain adjustment will have priority.

If desired, the **Exposure Time Limit** and the **Gain Limit** parameters (see below) can be used to put limits on the auto controls.

- **Prioritize Framerate** = Automatic exposure time control and automatic gain control are both enabled. The camera's automatic exposure and gain adjustments will be biased so that the frame rate is maintained at as high a level as possible. Maintaining image quality is given a lower priority.

If desired, the **Exposure Time Limit** and the **Gain Limit** parameters (see below) can be used to put limits on the auto controls.

- **Prioritize Quality** = Automatic exposure time control and automatic gain control are both enabled. The camera's automatic exposure and gain adjustments will be biased so that image quality is maintained at as high a level as possible. Maintaining the frame rate is given a lower priority.

If desired, the **Exposure Time Limit** and the **Gain Limit** parameters (see below) can be used to put limits on the auto controls.

- **Manual Gain** = Automatic gain control is disabled, and you must manually set the gain by using the **Gain** parameter (see below).

Automatic exposure time control remains enabled. If desired, the **Exposure Time Limit** parameter (see below) can be used to put a limit on the auto exposure control.

- **Manual Exposure Time** = Automatic exposure time control is disabled, and you must manually set the exposure time by using the **Exposure Time** parameter (see below).

Automatic gain control remains enabled. If desired, the **Gain Limit** parameter (see below) can be used to put a limit on the auto gain control.

- **Manual Gain and Exposure Time** = Automatic gain control and automatic exposure time control are both disabled. You must manually set the gain and the exposure time by using the **Gain** and **Exposure Time** parameters (see below).

Note that the operation of the automatic gain and exposure time controls will be strongly influenced by the placement of the auto brightness mask. For more information about the auto brightness mask, see [page 26](#).

Exposure Offset - Is used to customize the operation of the camera's automatic controls. Negative settings will bias the auto controls toward producing darker images. Positive settings will bias the auto controls toward producing lighter images.

Backlight Compensation - Check the box to enable the camera's backlight compensation feature. This feature automatically compensates when the main lighting comes from behind the image subject.

Iris Mode - Sets the camera's iris mode.

- **Auto** = The iris will be automatically controlled by the camera.
- **Open** = The iris is fully open.
- **Closed** = The iris is fully closed.
- **Prioritize Open** = The iris control will attempt to keep the iris as open as possible while still maintaining good image quality.
- **Prioritize Closed** = The iris control will attempt to keep the iris as closed as possible while still maintaining good image quality.

The **Open** and **Closed** settings can be used to test the functionality of an iris mechanism.

The **Prioritize Open** and **Prioritize Closed** settings may improve image quality in certain situations. Trying these settings under your actual conditions is the best way to determine whether one of the settings is appropriate for your application.

Note that the operation of the automatic iris control will be strongly influenced by the placement of the auto brightness mask. For more information about the auto brightness mask, see [page 26](#).

Anti-Flicker - Enables or disables the anti-flicker feature. If the camera is operating in an environment where the lighting flickers at a 50 Hz or a 60 Hz rate (such as incandescent or fluorescent lights), the flickering lights can cause significant changes in brightness from image to image. Enabling the anti-flicker feature may reduce the effect of the flickering in the captured images.

Note that the **Anti-Flicker** feature will only be available when the **Exposure Mode** parameter (see above) is set to one of the "prioritize" modes.

Exposure Time Limit - When automatic exposure time control is enabled (see **Exposure Mode** above), the **Exposure Time Limit** parameter sets the maximum exposure time that the automatic exposure control can use. If the **Exposure Time Limit** is set to "Off", there will be no limit for the automatic exposure control.

Note that if the **Anti-Flicker** feature is enabled, the **Exposure Time Limit** parameter setting:

- must be 1/50 s or greater when the anti-flicker setting is 50 Hz.
- must be 1/60 s or greater when the anti-flicker setting is 60 Hz.

Exposure Time - When automatic exposure time control is disabled (see **Exposure Mode** above), the **Exposure Time** parameter sets the exposure time for the captured images.

Note that if automatic exposure time control is enabled, the **Exposure Time** parameter will be read-only and will indicate the current exposure time value as set by the automatic control.

Gain Limit - When automatic gain control is enabled (see **Exposure Mode** above), the **Gain Limit** parameter sets the maximum amount of gain that the automatic gain control can use. If the **Gain Limit** is set to "Off", there will be no limit for the automatic gain control.

Gain - When automatic gain control is disabled (see **Exposure Mode** above), the **Gain** parameter sets the gain for the captured images. Gain refers to the amount of amplification that is applied to the pixel values in each captured image. A higher setting means more amplification.

Note that if automatic gain control is enabled, the **Gain** parameter will be read-only and will indicate the current gain value as set by the automatic control.

3.3.2 Appearance Tab

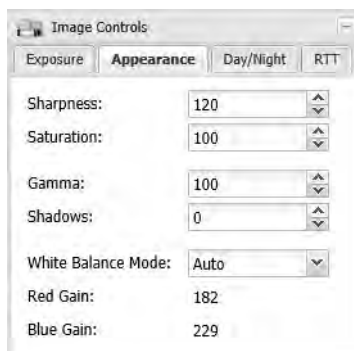

Sharpness - Sets the sharpness of the images transmitted by the camera. Higher settings produce sharper images.

Saturation - Sets the color saturation of the images transmitted by the camera. Higher settings produce more saturated (colorful) images.

Gamma - Sets the degree of gamma correction applied to captured images. Gamma corrects the captured images for non-linearities in the human eye's perception of brightness.

A setting of 100 represents a gamma correction factor of 1, and the appearance of the captured images will not be changed. A setting of 50 represents a gamma correction factor of 0.5. A setting of 150 represents a gamma correction factor of 1.5.

Shadows - Increases the contrast in dark areas of an image by selectively lightening the pixels in those areas alone. As a result, more detail is visible that would otherwise have been shades of black and gray. A setting of 0 means no pixels will be changed. Increasing the value, increases the lightening effect.

White Balance Mode - Sets the camera's automatic white balance mode.

- **Auto** = The camera will automatically adjust the white balance and the white balance adjustments will be updated continuously as lighting conditions change. The white balance control will assume average lighting conditions.

The automatic white balance control attempts to continuously balance the intensity of the red, green, and blue pixels in the captured images so that the white areas of the captured images always appear white (and not, for example, red tinted or green tinted).

Note that the operation of the automatic white balancing function will be strongly influenced by the placement of the white balance mask. For more information about the white balance mask, see [page 25](#).

- **Auto Preset** = The camera will attempt to identify the type of lighting present (i.e., daylight, incandescent, fluorescent, etc.) and then will automatically adjust the white balance based on the lighting type detected. This selection works best when the lighting conditions are uniform.
- **Daylight** = The camera will automatically change the white balance settings so that they are biased for daylight lighting conditions (a color temperature of 5500 K). Once the settings are changed, the white balance will stay fixed at that point.
- **Incandescent** = The camera will automatically change the white balance settings so that they are biased for incandescent lighting (a color temperature of 3000 K). Once the settings are changed, the white balance will stay fixed at that point.
- **Fluorescent I** = The camera will automatically change the white balance settings so that they are biased for normal fluorescent lighting (a color temperature of 2700 K). Once the settings are changed, the white balance will stay fixed at that point.
- **Fluorescent II** = The camera will automatically change the white balance settings so that they are biased for bright fluorescent lighting (a color temperature of 4000 K). Once the settings are changed, the white balance will stay fixed at that point.
- **Manual** = White balance is controlled manually. You can adjust the white balance by using the **Red Gain** and **Blue Gain** parameters (see below).

Red Gain - If the **White Balance Mode** parameter (see above) is set to manual, then the **Red Gain** parameter can be used to adjust the intensity of the red in the captured images. Decrease the setting to make the images less red, and increase the setting to make the images more red.

Note that if the **White Balance Mode** parameter is set to a value other than manual, the **Red Gain** parameter will be read-only and will indicate the current red gain value as set by the automatic white balance control.

Blue Gain - If the **White Balance Mode** parameter (see above) is set to manual, then the **Blue Gain** parameter can be used to adjust the intensity of the blue in the captured images. Decrease the setting to make the images less blue, and increase the setting to make the images more blue.

Note that if the **White Balance Mode** parameter is set to a value other than manual, the **Blue Gain** parameter will be read-only and will indicate the current blue gain value as set by the automatic white balance control.

3.3.3 Day/Night Tab

Note: The settings on this tab can only fully be used on day/night models of the camera. On non-day/night cameras, the parameter values will be indicated as "Fixed" or "Not Available". On cameras with an external IR-cut filter, only the IR Filter Mode parameter can be used to indicate whether the IR-cut filter is present or not.

Section 6 on [page 88](#) provides detailed information about how the camera's day/night functionality works. Basler recommends that you read this section before you set the parameters on the day/night tab.

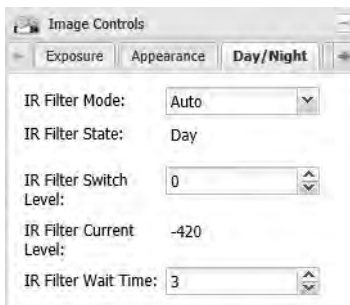

IR Filter Mode - Sets the mode of operation for the camera's IR-cut filter.

- **Auto** = The camera automatically senses the change from night to day or from day to night and sets the position of the camera's IR-cut filter accordingly.
- **Night** = Move the IR-cut filter to the night position (filter is not in front of the sensor) and keep it there. Available on cameras with external IR-cut filter.
- **Day** = Move the IR-cut filter to the day position (filter is in front of the sensor) and keep it there. Available on cameras with external IR-cut filter.
- **Input Controlled** = The position of the IR-cut filter will be controlled by the state of a camera I/O port. Available on cameras with external IR-cut filter.

For the input controlled mode to work correctly, the **Direction** parameter must be set to "Input" on the I/O port you want to use to control the filter position, and the **Function** parameter for that port must be set to "IR Switch". See Section 3.9 on [page 58](#) for more information about setting the camera's I/O port parameters.

IR Filter State - Indicates the current state of the camera's IR-cut filter.

- **Night** = The IR-cut filter is currently in the night position (filter is not in front of the sensor).
- **Day** = The IR-cut filter is currently in the day position (filter is in front of the sensor).

IR Filter Switch Level - When the **IR Filter Mode** parameter is set to auto, the **IR Filter Switch Level** setting is mainly used to adjust when the camera will switch from day mode to night mode. The higher the **IR Filter Switch Level** setting, the darker it must be before the camera will make the switch. Setting the switch level to a higher value typically means that the camera will switch from day mode to night mode later in the day, i.e., when it is darker.

If the current level of darkness (as indicated by the **IR Filter Current Level** parameter) rises above the switch level setting and remains there longer than the **IR Filter Wait Time** (see below), the camera will switch from day mode to night mode.

If the current level of darkness (as indicated by the **IR Filter Current Level** parameter) falls below the switch level setting and remains there longer than the **IR Filter Wait Time** (see below), the camera will switch from night mode to day mode.

IR Filter Current Level - Indicates the current level of darkness as measured by the camera's auto IR filter control. As the area being viewed by the camera gets darker, the value of the **IR Filter Current Level** will rise (a high positive value indicates that the area being viewed is very dark). As the area being viewed by the camera becomes brighter, the value of the **IR Filter Current Level** will fall (a large negative value indicates that the area being viewed is very bright).

IR Filter Wait Time - Sets the amount of time in seconds that the value of the **IR Filter Current Level** must remain above the **IR Filter Switch Level** setting before the camera will switch from day mode to night mode. It also sets the amount of time in seconds that the value of the **IR Filter**

Current Level must remain below the **IR Filter Switch Level** setting before the camera will switch from night mode to day mode.



A feature called the IR filter announce mode can use one of the camera's I/O ports to "announce" the current mode (night or day) of the IR-cut filter. For more information, see [page 90](#) and also Section 3.9.1 on [page 58](#).

This feature is not available on cameras with external IR-cut filter.

3.3.4 RTT Tab

The **RTT** tab offers similar parameters as the **Exposure** and **Appearance** tabs (see [page 15](#)) to allow the user to choose different settings for real-time triggered images. This is useful to account for different lighting conditions, for example, when using flash lighting for real-time triggered images.

Note: The **RTT** tab is only available on camera models with real-time trigger functionality. To find out whether your camera offers real-time triggering, check the specification tables in Chapter 8 on [page 100](#).

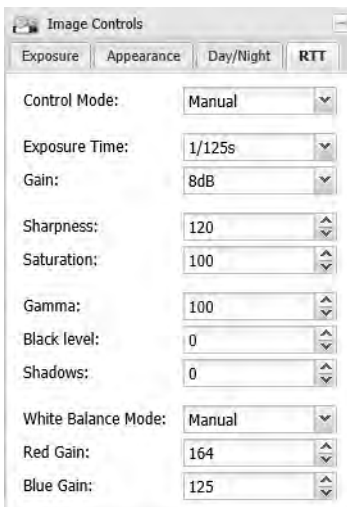

Control Mode - Determines how settings for real-time triggered images are controlled.

- **Manual** = Settings are controlled using the parameters on this tab.
- **Stream** = The same settings as on the **Exposure** and **Appearance** tabs will be used.
- **Manual (adaptive)** = This setting allows the camera to intelligently switch from using the settings on the **RTT** tab to using the general stream settings on the **Exposure** and **Appearance** tabs when the lighting conditions change. The camera is able to detect if, for example, a shorter exposure time than specified on the **RTT** tab is sufficient and can then use the stream settings instead. The following parameters are affected by this:
 - Exposure Time
 - Gain
 - White Balance Mode

For all other parameters, the settings on the **RTT** tab remain valid.

Exposure Time - Sets the exposure time.

Gain - Sets the gain. Gain refers to the amount of amplification that is applied to the pixel values in each captured image. A higher setting means more amplification.

Sharpness - Sets the sharpness of the images transmitted by the camera. Higher settings produce sharper images.

Saturation - Sets the color saturation of the images transmitted by the camera. Higher settings produce more saturated (colorful) images.

Gamma - Sets the degree of gamma correction applied to captured images. Gamma corrects the captured images for non-linearities in the human eye's perception of brightness.

A setting of 100 represents a gamma correction factor of 1, and the appearance of the captured images will not be changed. A setting of 50 represents a gamma correction factor of 0.5. A setting of 150 represents a gamma correction factor of 1.5.

Black Level - Sets a value for the black level compensation in order to achieve a higher contrast. A setting of 0 means no black level compensation will take place. At higher settings, the black level will be adjusted based on the internal black level of the image. The higher the setting, the higher the contrast.

Shadows - Increases the contrast in dark areas of an image by selectively lightening the pixels in those areas alone. As a result, more detail is visible that would otherwise have been shades of black and gray. A setting of 0 means no pixels will be changed. Increasing the value, increases the lightening effect.

White Balance Mode - Sets the operating mode for the white balance feature.

- **Stream** = If **Stream** is selected, the same white balance settings as on the **Appearance** tab will be used for real-time triggered images. For more information on these settings, see the "White Balance Mode" section on [page 15](#).
- **Manual** = If **Manual** is selected, white balance is controlled manually using the **Red Gain** and **Blue Gain** parameters (see below).

Red Gain - Sets the intensity of the red in the captured images. Decrease the setting to make the images less red, and increase the setting to make the images more red.

Blue Gain - Sets the intensity of the blue in the captured images. Decrease the setting to make the images less blue, and increase the setting to make the images more blue.

3.4 Streaming Parameters

The parameters in the **Streaming** group are used to control the characteristics of the image area that will be captured by the camera's sensor. They are also used to control the characteristics of the video streams that are output from the camera.

The camera can produce up to three individually configured video streams. The streams are designated as stream 0, stream 1, and stream 2. Stream 0 is always enabled. Streams 1 and 2 can be either enabled or disabled. Each stream can be accessed by multiple network users.

For more information about video streams, see Section 3.1 on [page 7](#).



When you open the **Streaming** parameters group, the camera enters the "configuration" mode. When you close the **Streaming** parameters group, the camera will return to "normal" mode and any parameter changes you made will be applied.

When the **Streaming** parameters group is open, the images displayed on any editor tabs in the web client will be refreshed approximately once per second.

3.4.1 Global Tab

The parameters on the **Global** tab control the way that the camera's imaging sensor will capture images. Because the images captured by the sensor are used for all three video streams, the parameters on this tab are considered to be "global", i.e., changes made here will affect what you can do when you work with the individual stream parameters.

Some of the parameters in this group are used to set the imaging sensor's "area of interest" (AOI). The sensor AOI settings let you define the area on the sensor that will actually be used when the camera is capturing images. You can set the AOI settings so that the full sensor is used to capture images or so that just a portion of the sensor is used as shown in Figure 3.

The **Sensor AOI Width** and **Sensor AOI Height** parameters define the width and height (in pixels) of the image area that will be captured. The **Sensor AOI Top** and **Sensor AOI Left** parameters define where the image area will be located in relation to the top left corner of the sensor.

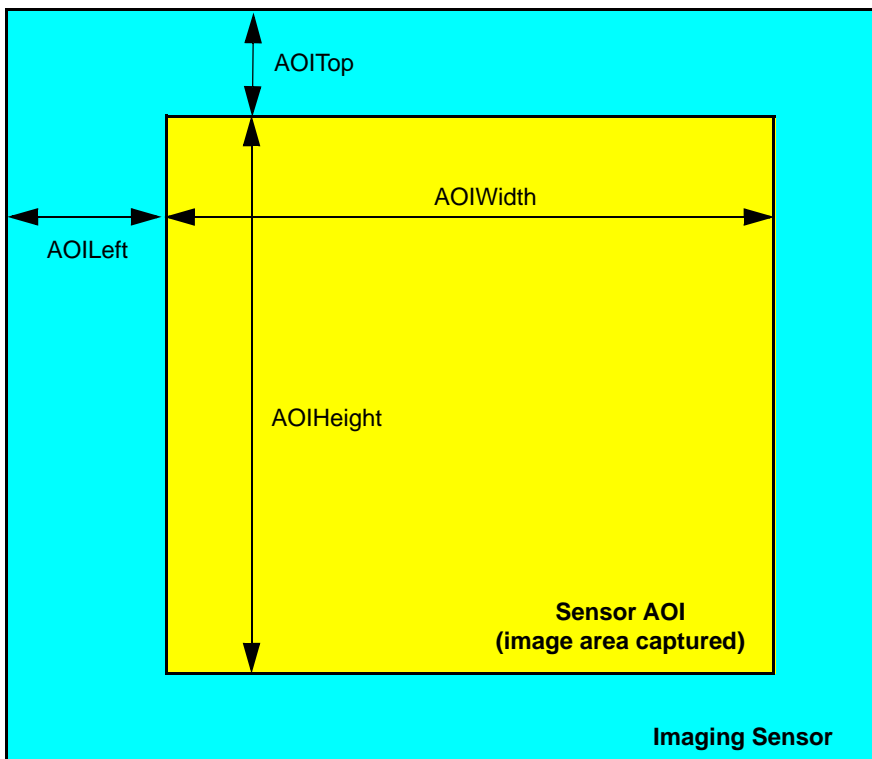
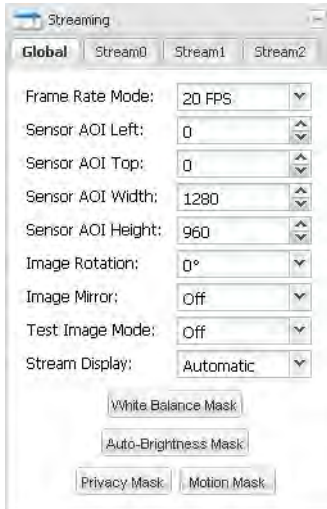

Fig. 3: Sensor AOI

Why Decrease the Sensor AOI Size?

On some camera models, typically those with large imaging sensors, the maximum rate at which the sensor can capture images (i.e., the frame rate) is limited. On these cameras, when you decrease the height of the sensor AOI, the rate at which the sensor can capture images will increase. So if you need to capture images at a higher rate, decreasing the size of the sensor AOI may be a workable option that will allow you to do so.



Frame Rate Mode - Sets the rate at which the camera's sensor will capture frames (images). For example, selecting 30 FPS means that the camera's imaging sensor will capture 30 frames per second if allowed with the current camera settings.

You should use this parameter to set the frame rate mode when the **Function** parameter on the **Digital I/O** tab is set to "External Trigger" (see [page 58](#)).

Note that on some camera models, typically those with large imaging sensors, the maximum rate at which the sensor can capture images (i.e., the frame rate) is limited. On these cameras, if you decrease the height of the sensor AOI, the rate at which the sensor can capture images will increase. So if you decrease the setting for the **AOI Height** parameter, you may see an increase in the maximum setting available for the **Frame Rate Mode** parameter.

Sensor AOI Left - As shown in Figure 3 on [page 21](#), sets the left offset (in pixels) for the sensor AOI, i.e., how far the sensor AOI will be offset from the left edge of the sensor. When you adjust this setting, you will notice that it must be changed in certain fixed increments.*

Sensor AOI Top - As shown in Figure 3 on [page 21](#), sets the top offset (in pixels) for the sensor AOI, i.e., how far the sensor AOI will be offset from the top edge of the sensor. When you adjust this setting, you will notice that it must be changed in certain fixed increments.*

Sensor AOI Width - As shown in Figure 3 on [page 21](#), sets the width (in pixels) of the sensor AOI. When you adjust this setting, you will notice that it must be changed in certain fixed increments.*

Sensor AOI Height - As shown in Figure 3 on [page 21](#), sets the height (in pixels) of the sensor AOI. When you adjust this setting, you will notice that it must be changed in certain fixed increments.*

* You can also use the **Sensor AOI Editor** (see [page 24](#)) to set this parameter. Any changes you make to the AOI parameter settings on the **Global** tab will be reflected in the **Sensor AOI Editor**.

Image Rotation - Sets the degree of rotation for the images captured by the sensor.

- **0°** = Do not rotate the images.
- **180°** = Rotate the images 180 degrees.

Image Mirror - Enables or disables image mirroring.

- **Off** = Image mirroring is disabled.
- **Horizontal** = Horizontal mirroring is enabled. (The image will be flipped left to right.)
- **Vertical** = Vertical mirroring is enabled. (The image will be flipped top to bottom.)
- **Both** = Horizontal and vertical mirroring are both enabled.

Test Image Mode - Enables or disables the camera's test image feature. When the test image mode is enabled, the camera will generate test images using its digital devices rather than the imaging sensor. The generated test images will be transmitted on all enabled streams. Test images are useful for troubleshooting the camera's basic functionality and the network connection.

- **Off** = The test image feature is disabled.
- **On** = The test image feature is enabled. The camera will stream test images that include diagonal red, green, and blue gradients. The gradients will appear to move as the test images are received.

Stream Display - Selects the plugin that will be used to display encoded images in the web client's stream tabs.

- **Automatic** = Automatically selects the most appropriate plugin from the plugins currently installed on your web browser.
- **Basler Plugin** = Select the Basler plugin. The Basler Plugin is a good choice for displaying the images. Note that if you have not installed the Basler ActiveX control on your browser, the Basler Plugin will not be available for selection.
- **"Plugin Name" Plugin** = Select the "*Plugin Name*" plugin. Depending on what plugins you have installed for your web browser, several different plugins may be listed. Each plugin will be listed by name. A plugin will only be listed here if it has been installed and can display the encoded images.
- **No Display** = Display of image streams within the web client is disabled. You will still be able to change parameter settings. This is a good choice if you only want to use the web client to change settings. Access to the settings is faster with image display disabled.

Sensor AOI Editor - Whenever the **Global** tab is selected, the **Sensor AOI Editor** tab will also be available as shown below. You can use the editor to set the sensor AOI size and position rather than entering numbers in the boxes on the **Global** tab. To set the sensor AOI with the editor, simply use your mouse to drag the edges of the rectangle that represents the sensor AOI. If the AOI is set to the full size of the sensor area in the editor, you won't see a rectangle. In that case, hover with your mouse over one of the corners of the sensor area. When the pointer turns into a left-right arrow, click the left mouse button and drag the AOI to the desired size. You can also use the buttons at the bottom of the editor to set the AOI to the full size or a 1/4 of the size of the sensor, to align the AOI to the top left side of the sensor, or to center the AOI on the sensor.

Note: The **1/4 Size** button will not be present on some camera models.

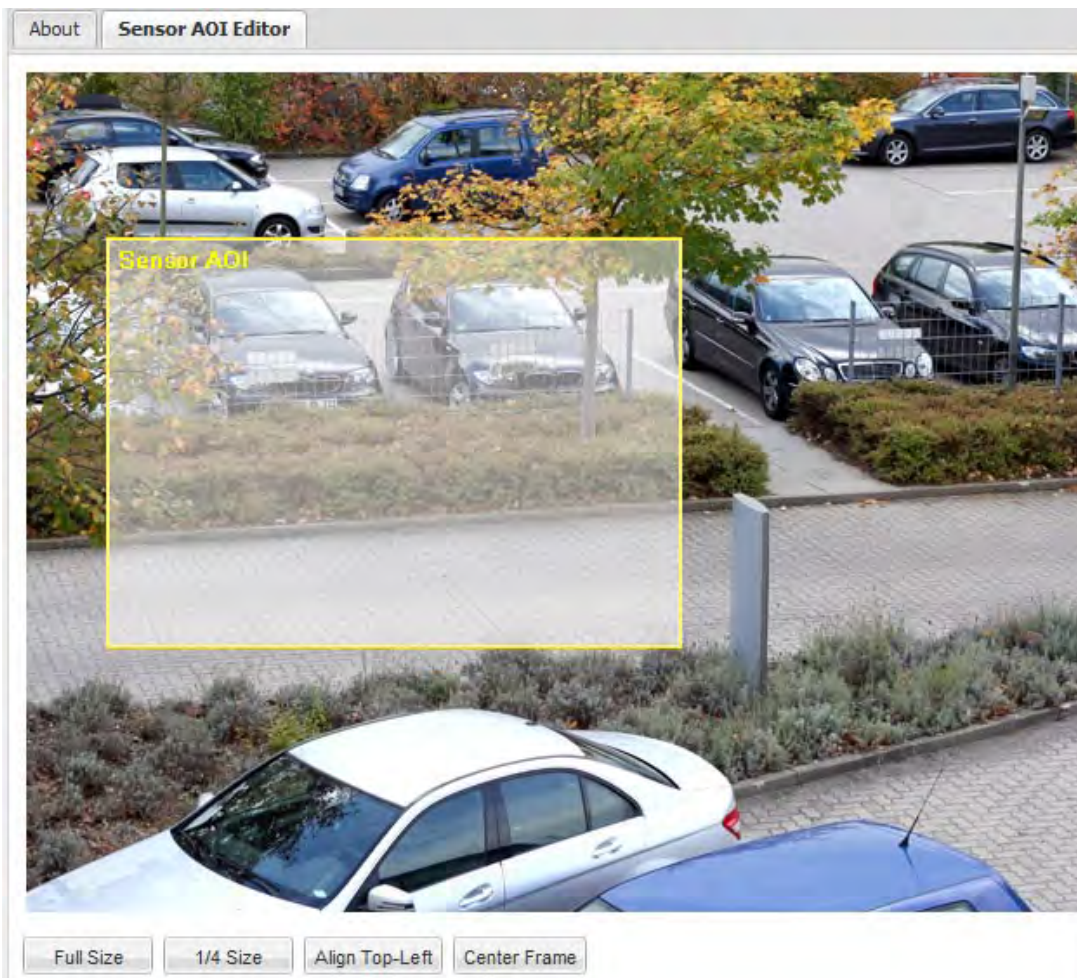

In addition to the Sensor AOI Editor, there are the following 4 editors:

- White Balance Mask Editor
- Auto Brightness Mask Editor
- Privacy Mask Editor
- Motion Mask Editor

White Balance Mask - Click the **White Balance Mask** button to open the **White Balance Mask Editor** as shown below.

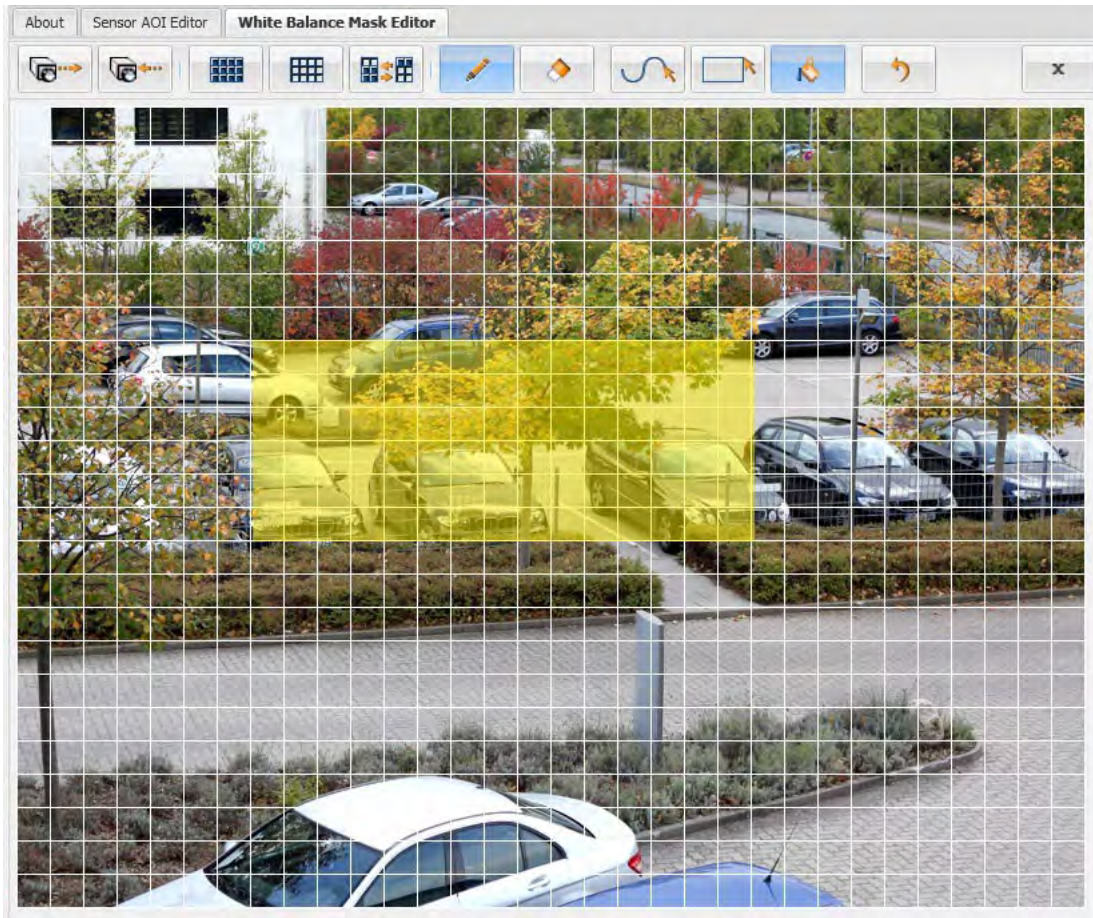

The white balance mask defines the area(s) of the image that will be used by the camera's automatic white balancing function when the **White Balance Mode** parameter is set to **Auto** (see Section 3.3 on [page 13](#)). Only the areas highlighted in the editor will be included in the white balance mask. To highlight an area within the editor, use the tools described under "Mask Editor Tools" on [page 29](#).

The area under the mask will be used by the automatic white balance control to define what "white" is. So you should always place the white balance mask over an area of the image that is truly a white area. If you place the mask over, for example, a green area of the image, you will find that the color balance in your captured images is badly skewed when the **White Balance Mode** parameter is set to **Auto**.

Auto Brightness Mask - Click the **Auto Brightness Mask** button to open the **Auto Brightness Mask Editor** as shown below.

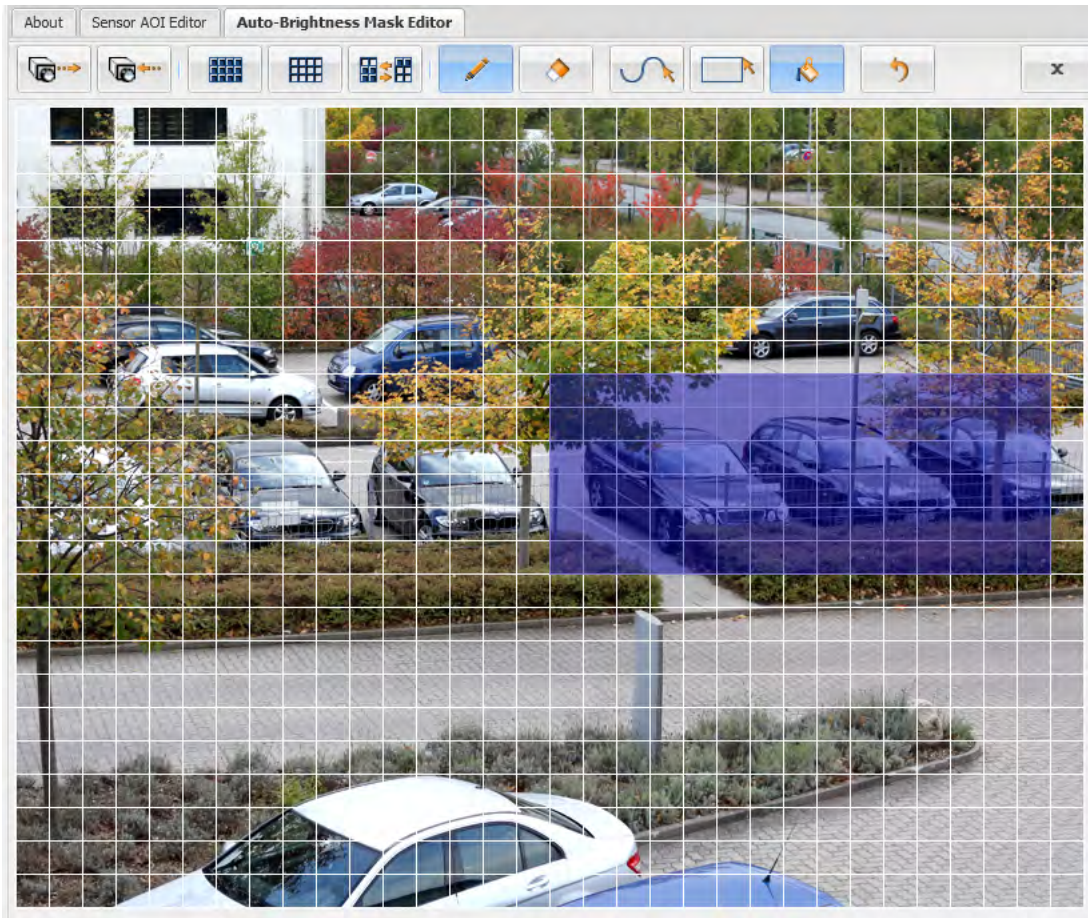

The auto brightness mask defines the area(s) of the image that will be used by the camera when it performs automatic exposure, gain, and iris control (see Section 3.3 on [page 13](#)). Only the areas highlighted in the editor will be included in the auto brightness mask. To highlight an area within the editor, use the tools described under "Mask Editor Tools" on [page 29](#).

Normally, you should position the mask so that it covers the brightest areas of the image. This will typically yield the best performance from the automatic exposure, gain, and iris controls.

Privacy Mask - Click the **Privacy Mask** button to open the **Privacy Mask Editor** as shown below.

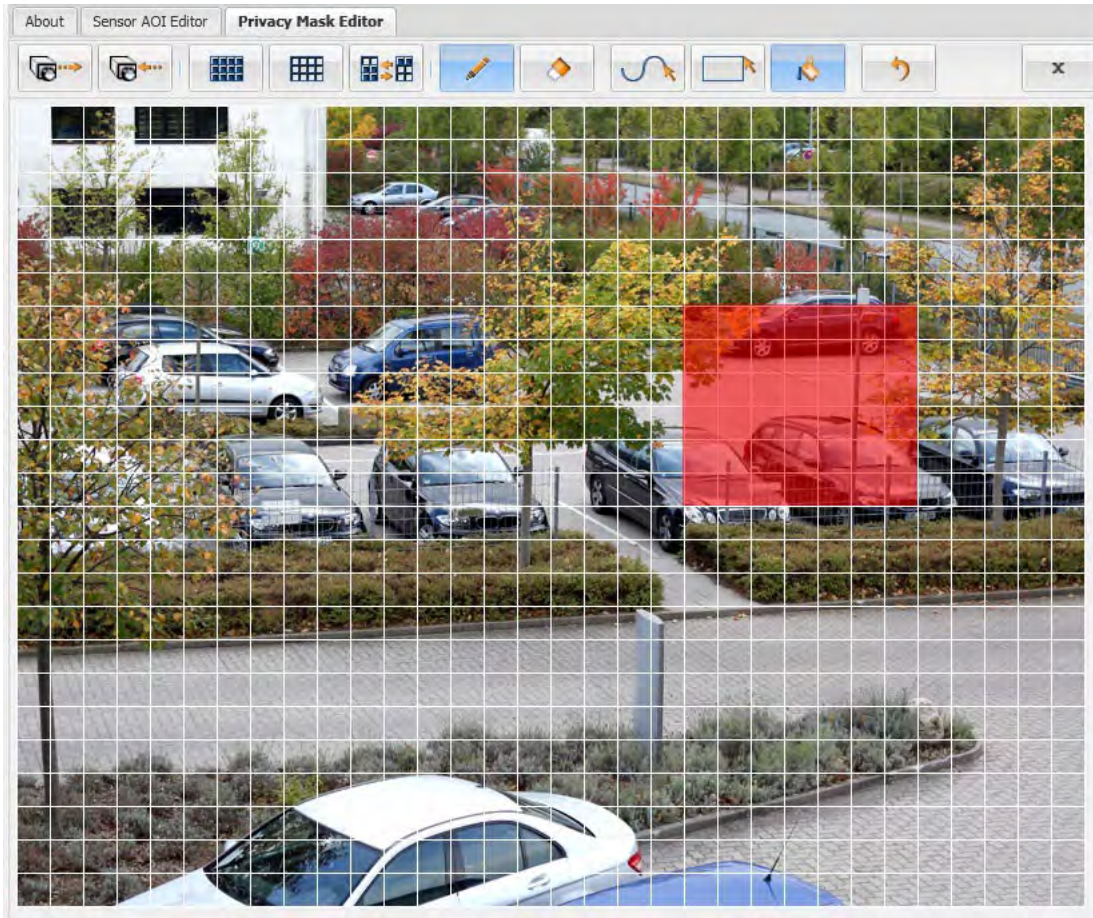

The privacy mask defines the area(s) of the image that will be blacked out in the images in the video streams. Only the areas highlighted in the editor will be included in the privacy mask and will be blacked out. To highlight an area within the editor, use the tools described under "Mask Editor Tools" on [page 29](#).



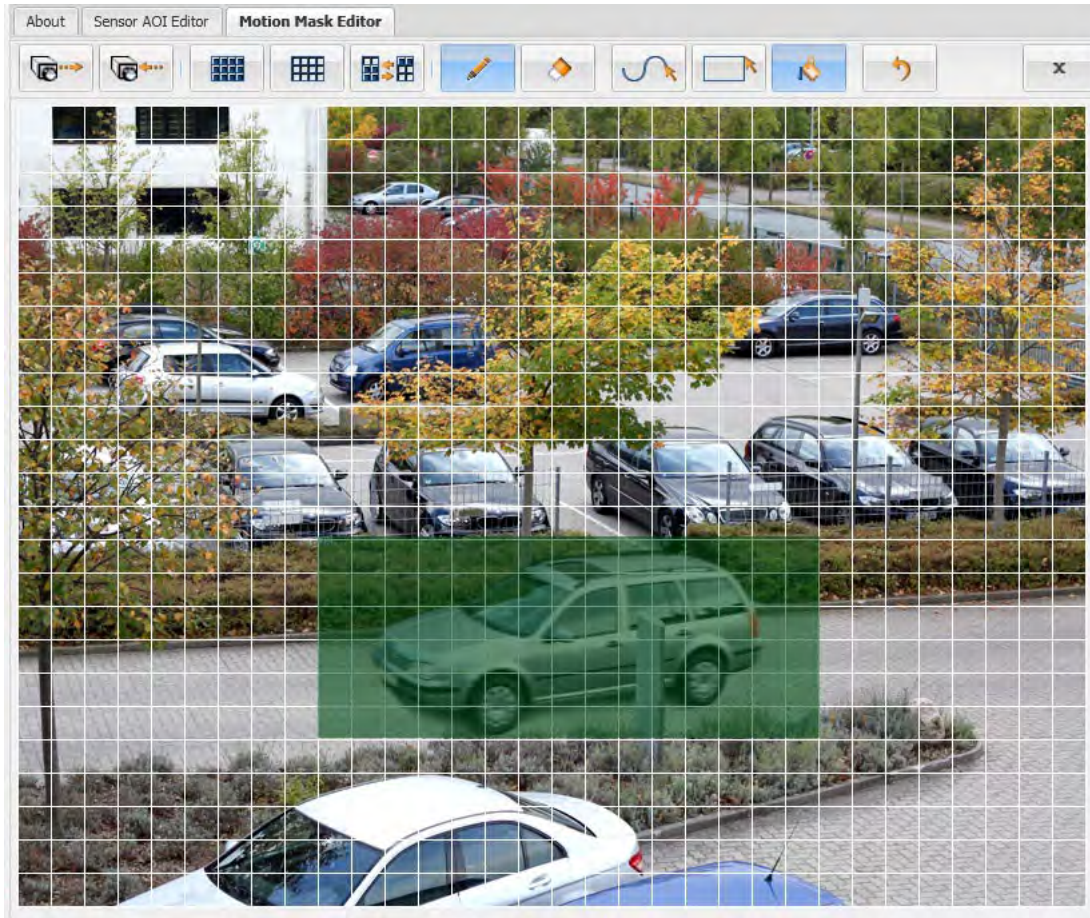









Motion Mask - Click the **Motion Mask** button to open the **Motion Mask Editor** as shown below.



The motion mask defines the area(s) of the image that will be used for the camera's motion detection function (see Section 3.5 on [page 41](#)). Only the areas highlighted in the editor will be included in the motion detection mask and used for motion detection. To highlight an area within the editor, use the tools described in the following section.

Mask Editor Tools

To apply a mask, all editors use the same tools. These are arranged in a toolbar at the top of each editor's tab. With the tools, you can mask the entire sensor area, a single area or several different areas within the image.

	Load Saved Mask from Camera	Loads the mask settings that are currently saved on the camera and displays them in the editor.
	Save Mask to Camera	Saves the current mask settings to the camera.
	Mask All	Applies the respective mask to the entire sensor area in the editor.
	Unmask All	Removes all masked areas from the sensor area in the editor.
	Invert Mask	Inverts the current mask settings, i.e. areas that were unmasked before will now be masked and vice versa.
	Draw	Activates the function for drawing and flood-filling areas that should be used as a mask. Click this, and then choose the Rectangle , Freehand , or Flood Fill buttons to define masked areas.
	Erase	Activates the function for erasing drawn and flood-filled areas that are used as masks. Click this, and then choose the Rectangle , Freehand , or Flood Fill buttons to erase masked areas.
	Freehand	Draws a freehand line which can also be joined up to create a closed area. A closed area will only become a fully masked area after it has been flood-filled.
	Rectangle	Draws a rectangular shape. The entire shape will only become a fully masked area after it has been flood-filled.
	Flood Fill	Flood-fills a selected section, thereby defining it as a masked area. To do this, click the Flood Fill button and then click inside the shape to fill it.
	Undo	Undoes the last actions one by one in chronological order. All actions performed since the last save can be undone.
	Close	Closes the mask editor.

3.4.2 Stream Tabs

The parameters on the **Stream 0** tab, **Stream 1** tab, and **Stream 2** tab control the way that the video stream associated with the selected tab is configured.

This section describes the settings on the **Stream 0** tab, the settings available on the **Stream 1** and **Stream 2** tabs are identical to the **Stream 0** tab.

Some of the parameters on each stream tab are used to set the "area of interest" (AOI) for the video stream controlled by the tab. The stream AOI settings on a tab let you define an area within the image area being captured by the camera's sensor and only the pixel data from the defined area will be encoded and streamed in the stream controlled by the tab. You can set the stream AOI settings so that the entire image area is encoded and streamed or so that just a portion of the image area is encoded and streamed.

The **Stream AOI Width** and **Stream AOI Height** parameters define the width and height (in pixels) of the area that will be encoded and streamed. The **Stream AOI Top** and **Stream AOI Left** parameters define where the area will be located in relation to the top left corner of the image area that was captured by the imaging sensor. (See Section 3.4.1 on [page 21](#) for more information about defining the image area captured by the sensor.)

Why Decrease the Stream AOI Size?

In some installations, the network bandwidth available may be limited. Decreasing the size of the stream AOI will decrease the amount of data in each image. This in turn will reduce the amount of data that must be streamed across the network and thus decrease the bandwidth required.

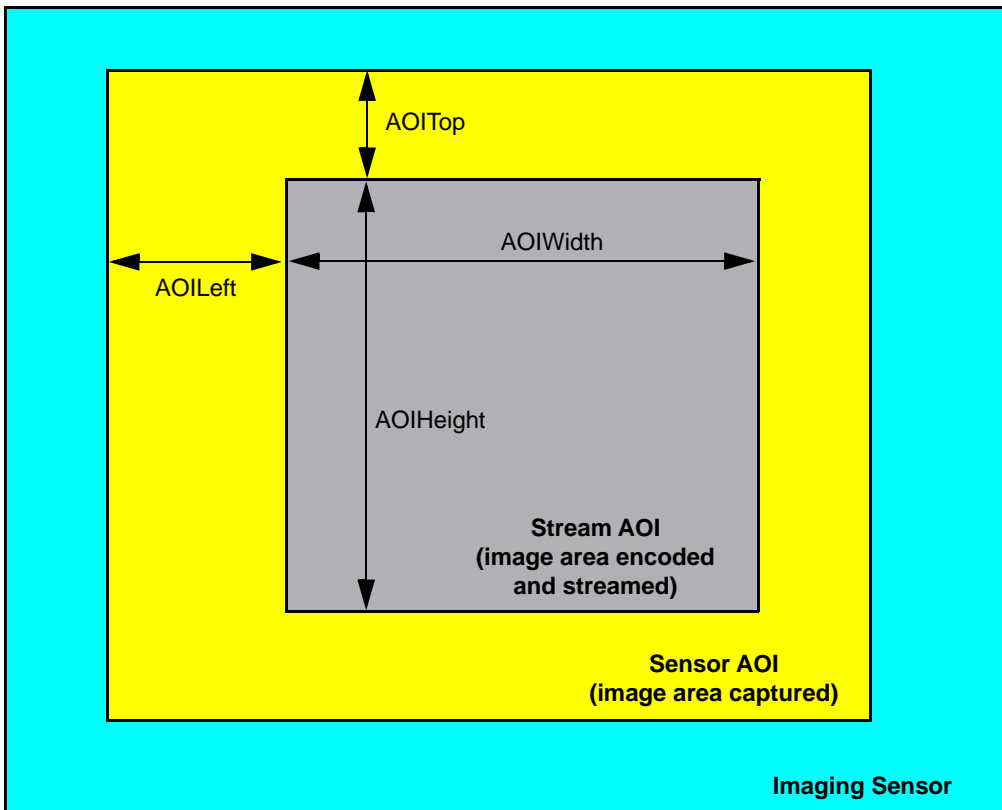
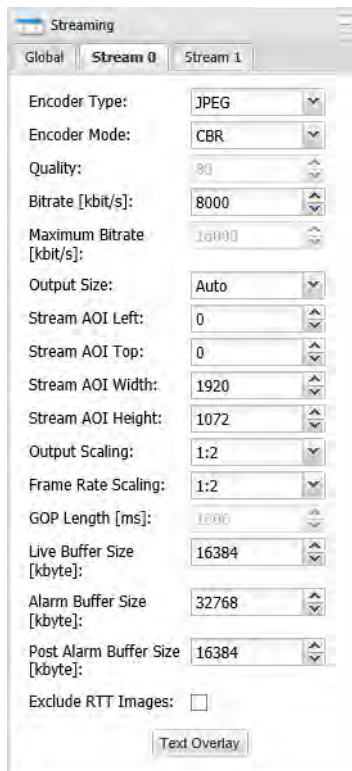

Fig. 4: Stream AOI



Encoder Type - Sets the video encoder type for the stream.

- **Off** = The video stream is disabled and no images will be streamed. This setting is only available on the **Stream 1** and **Stream 2** tabs. Stream 0 is always enabled, and the off setting is not available for this stream.
- **JPEG** = The camera will use motion JPEG (MJPEG) encoding for the images streamed. The motion JPEG format uses standard JPEG still images to create the video stream. The stream of still images is displayed and updated at a rate that shows constantly updated motion. Although MJPEG encoding does compress the images to some degree and although this compression is usually described as "lossy", MJPEG encoding results in high-quality image transmission. However, high bandwidth is required to transmit the images.
- **MPEG4** = The camera will use MPEG4 encoding for the images streamed. MPEG4 encoding uses compression techniques that are not as efficient as H.264, but are significantly more efficient than MJPEG encoding. Using MPEG4 encoding will noticeably lower the bandwidth required to transmit images as compared to using MJPEG.

Note that if the sensor AOI (see Section 3.4.1 on [page 21](#)) is set to a size greater than 1920 x 1920, MPEG4 cannot be used as the encoder type. This restriction only applies to camera models with a sensor large enough to allow a sensor AOI greater than 1920 x 1920 (see Section 8 on [page 100](#) for information about the sensor size in each camera model).

- **H.264 Base Profile** = The camera will use H.264 base profile encoding for the images streamed. H.264 encoding uses advanced compression techniques, that yield the most significant lowering in the bandwidth required to transmit the images.
- **H.264 High Profile** = The camera will use H.264 high profile encoding for the images streamed.

(For H.264 encoding, the profile defines a set of capabilities for the encoder. You should try to match the H.264 profile you select on the camera to the profile used by the decoder in the device receiving the images from the camera.)

- **JPEG (RT triggered)** = The camera will only stream MJPEG images that have been triggered using the camera's real-time trigger feature.

For more information about the real-time trigger feature, see Section 7 on [page 95](#).

(continued on next page)

Encoder Type - (continued from previous page)

- **YUV (RT triggered)** = The camera will use the I420 color format for outputting uncompressed YUV images. The output will be an HTTP stream. Live recording is also supported. This encoder type is available when using the camera's real-time trigger feature.

For more information about the real-time trigger feature, see Section 7 on [page 95](#).

Note that the large size of the uncompressed YUV images may have an impact on the camera's overall performance.

For more information about the YUV encoder type, see the *Lossless YUV Images* application note (AW001261). You can download this document from the Basler website: www.baslerweb.com

Encoder Mode - Sets the encoder mode for the stream.

- **CBR** = The encoder will operate in Constant Bitrate mode. The encoder attempts to maintain a constant output bit rate by adjusting image quality as necessary. The bit rate will be determined by the setting of the **Bitrate** parameter.

(Setting the **Encoder Mode** to **CBR** can help you conserve bandwidth. When **CBR** is selected, you can set the **Bitrate** parameter to a low value and this will cause the camera to use less bandwidth. This is especially useful if you are operating a system with multiple cameras.)

- **VBR** = The encoder will operate in Variable Bitrate mode. The encoder attempts to maintain constant image quality by adjusting the output bit rate as necessary. The quality level will be determined by the setting of the **Quality** parameter.

Note that if the **Encoder Type** parameter is set to **JPEG (triggered)**, the **Encoder Mode** parameter setting will be fixed at **VBR**.

- **CVBR** = The encoder will operate in Constant-Variable Bitrate mode. As long as there is no motion in the scene, the encoder attempts to maintain a constant output bit rate by adjusting image quality as necessary. The bit rate will be determined by the setting of the **Bitrate** parameter.

When the scene includes motion, the camera will increase the output bit rate (up to a maximum determined by the setting of the **Maximum Bitrate** parameter) for an extended period of time. When that time ends, the camera will reduce the bit rate as needed to achieve a long term average bit rate equal to the setting of the **Bitrate** parameter.

Note that the **CVBR** setting will only be available when the **Encoder Type** parameter is set to **H.264 Base Profile** or **H.264 High Profile**.

- **Capped VBR** = The encoder will operate in Capped Variable Bitrate mode. This is the default mode when communication with the camera occurs via ONVIF. By setting both the **Quality** and **Maximum Bitrate** parameters, you can ensure that the encoder attempts to maintain the desired quality without exceeding a certain bitrate at which the performance of the camera would be negatively affected.

Note that the **Capped VBR** setting is only valid when the **Encoder Type** parameter is set to **H_264** or **JPEG**.

Quality - If the **Encoder Mode** parameter is set to **VBR**, then the **Quality** parameter will determine the quality level of the images in the stream. A higher setting means better quality.

Using higher quality settings will reduce the rate at which the camera can encode and stream images. Using lower quality settings will increase the rate.

If the **Encoder Mode** parameter is set to **Capped VBR**, you can also set the desired quality of the stream by using the **Quality** parameter.

Note that the effect of the quality setting is not precisely equivalent for each encoder type. For example, a quality setting of 50 will have a slightly different effect when the **Encoder Type** parameter is set to JPEG than it will have when it is set to MPEG4 or to H.264.

Bitrate - If the **Encoder Mode** parameter is set to **CBR**, then the **Bitrate** parameter sets the bitrate for the stream.

If the **Encoder Mode** parameter is set to **CVBR**, then the **Bitrate** parameter sets the bitrate for the stream when there is no motion in the scene.

Maximum Bitrate - If the **Encoder Mode** parameter is set to **CVBR**, then the **Maximum Bitrate** parameter sets the maximum bitrate for the stream when there is motion in the scene.

If the **Encoder Mode** parameter is set to **Capped VBR**, you can use the **Maximum Bitrate** parameter to ensure that the bitrate doesn't rise above a certain value when trying to achieve the quality value set with the **Quality** parameter.

Output Size - Lets you select from a list of standard image sizes. When you select a size, the camera checks the setting of the **Output Scaling** parameter. It then automatically sets the **Stream AOI Left**, **Stream AOI Top**, **Stream AOI Width**, and **Stream AOI Height** parameters so that the AOI will be centered on the sensor and set to the correct width and height to result in output images of the size you selected.

Note that depending on the current setting of the **Output Scaling** parameter, some of the standard sizes normally available may not be listed.

The sizes available in the list will vary depending on the camera model you are using, and the list will only include output sizes that can be achieved given the current **Output Scaling** parameter setting. The list below contains all possible sizes.

- **Auto** = The image size is non-standard. (Whenever you manually change the **Stream AOI Width** parameter or the **Stream AOI Height** parameter to a value that will not result in standard size image output, the value of the **Output Size** parameter will change to "Auto").
- **2560 x 1920** = The size of the images in the stream will be 2560 x 1920.
- **1920 x 1080 (Full HD)** = The size of the images in the stream will be 1920 x 1080.
- **1600 x 1200 (UXGA)** = The size of the images in the stream will be 1600 x 1200.
- **1408 x 1152 (16CIF)** = The size of the images in the stream will be 1408 x 1152.
- **1280 x 1024 (SXGA)** = The size of the images in the stream will be 1280 x 1024.
- **1280 x 960** = The size of the images in the stream will be 1280 x 960.
- **1280 x 720 (HD 720)** = The size of the images in the stream will be 1280 x 720.
- **1056 x 864 (9CIF)** = The size of the images in the stream will be 1056 x 864.
- **1024 x 768 (XGA)** = The size of the images in the stream will be 1024 x 768.
- **800 x 600 (SVGA)** = The size of the images in the stream will be 800 x 600.
- **720 x 576 (D1 PAL)** = The size of the images in the stream will be 720 x 576.
- **720 x 480 (D1 NTSC)** = The size of the images in the stream will be 720 x 480.
- **704 x 576 (4CIF)** = The size of the images in the stream will be 704 x 576.

- **640 x 480 (VGA)** = The size of the images in the stream will be 640 x 480.
- **480 x 360** = The size of the images in the stream will be 480 x 360.
- **352 x 288 (CIF)** = The size of the images in the stream will be 352 x 288.
- **320 x 240 (QVGA)** = The size of the images in the stream will be 320 x 240.
- **176 x 144 (QCIF)** = The size of the images in the stream will be 176 x 144.
- **160 x 120 (QQVGA)** = The size of the images in the stream will be 160 x 120.

Stream AOI Left - As shown in Figure 4 on [page 30](#), sets the left offset (in pixels) for the stream AOI, i.e., how far the stream AOI will be offset from the left edge of the image area captured by the camera's sensor. When you adjust this setting, you will notice that it must be changed in certain fixed increments.*

Stream AOI Top - As shown in Figure 4 on [page 30](#), sets the top offset (in pixels) for the stream AOI, i.e., how far the stream AOI will be offset from the top edge of the image area captured by the camera's sensor. When you adjust this setting, you will notice that it must be changed in certain fixed increments.*

Stream AOI Width - As shown in Figure 4 on [page 30](#), sets the width (in pixels) of the stream AOI. When you adjust this setting, you will notice that it must be changed in certain fixed increments.*

Stream AOI Height - As shown in Figure 4 on [page 30](#), sets the height (in pixels) of the stream AOI. When you adjust this setting, you will notice that it must be changed in certain fixed increments.*

* You can also use the **Stream AOI Editor** (see [page 40](#)) to set this parameter, and any changes you make to the AOI parameter settings on the **Stream** tab will be reflected on the **Stream AOI Editor**.

Output Scaling - Sets the amount that captured images will be rescaled before they are encoded and transmitted in the stream.

- **1:1** = No rescaling.
- **1:2** = Rescale to 1/2 size.
- **1:4** = Rescale to 1/4 size.
- **1:8** = Rescale to 1/8 size.

Note that increasing the level of output scaling will decrease the workload on the processor in the camera.



BIP2-1920-30c only

When using cameras of this model, at least one stream always has to be set to **1:1**, i.e. no rescaling takes place. If you're only using one stream and the **Output Scaling** parameter is set to a different value than **1:1**, the camera opens a second stream internally which is set to **1:1**. This may lead to an increased workload on the processor and may reduce the maximum frame rate.

Frame Rate Scaling - Sets the ratio of captured images to encoded images.

- **1:1** = Every image captured by the camera's sensor will be encoded and streamed.
- **1:2** = Every second image captured by the camera's sensor will be encoded and streamed.
- **1:4** = Every fourth image captured by the camera's sensor will be encoded and streamed.
- **1:8** = Every eighth image captured by the camera's sensor will be encoded and streamed.

Note that increasing the level of frame rate scaling will decrease the bandwidth used to stream images from the camera to a device.

Note that if the **Encoder Type** parameter is set to **JPEG (triggered)**, the **Frame Rate Scaling** parameter setting will be fixed at **1:1**.

GOP Length [ms] - If the **Encoder Type** parameter is set to H.264 or MPEG4, then the **GOP Length** parameter will set the time between I-frames in milliseconds.

In an H.264 or an MPEG stream, the camera transmits periodic I-frames and transmits several P-frames between each I-frame. I-frames carry complete information for a captured image. P-frames only carry information about the areas of the image that have changed since the last I-frame was transmitted. The time between the transmission of I-frames is determined by the **GOP Length** parameter. Increasing the time between I-frames (i.e., the GOP length) will increase the efficiency of the encoder. But be aware that increasing the GOP length also increases the latency when you start an image stream because the decoder in the receiving device must wait longer for the initial I-frames.

Live Buffer Size [kbyte] - Sets the size (in kilobytes) of the live buffer for the stream. The live buffer is a ring buffer that stores the last n captured images for the stream (n depends on the size of the images being encoded and the size of the buffer).

Alarm Buffer Size [kbyte] - Sets the size (in kilobytes) of the alarm buffer for the stream. Normally, the alarm buffer is simply a ring buffer that stores the last n captured images for the stream (n depends on the size of the images being encoded and the size of the buffer). But when an alarm condition is declared, the alarm buffer will only continue to buffer post alarm images until the portion of the buffer that is allocated for post alarm image storage is full (see the next parameter). At that point, buffering will stop, and the pre and post alarm images held in the buffer will be retained until a new **Alarm Buffer Arm** command is issued (see Section 3.6.2 on [page 45](#)).

Post Alarm Buffer Size [kbyte] - Sets the portion of the alarm buffer (in kilobytes) that will be used for "post alarm" image storage. For example, if the **Alarm Buffer Size** parameter is set to 2048 kilobytes and the **Post Alarm Buffer Size** parameter is set to 1228 kilobytes, then 1228 kilobytes (i.e., 60 %) of the alarm buffer will be allocated for holding post alarm images.

Exclude RTT Images - If the **Encoder Type** parameter is set to a non-RTT type and manual control for real-time triggered images is enabled, real-time triggered images can be excluded from the live stream by selecting this check box. If the **Control Mode** parameter is set to **Stream**, this check box can't be selected.

Text Overlay - Click the **Text Overlay** button to open the **Text Overlay** dialog box as shown below. The dialog box contains two tabs, **Text Overlay 1** and **Text Overlay 2**, that let you define two different sets of text to appear in a bar at the top or the bottom of each image transmitted in the stream. The two tabs are identical and, therefore, the options described below apply to both.

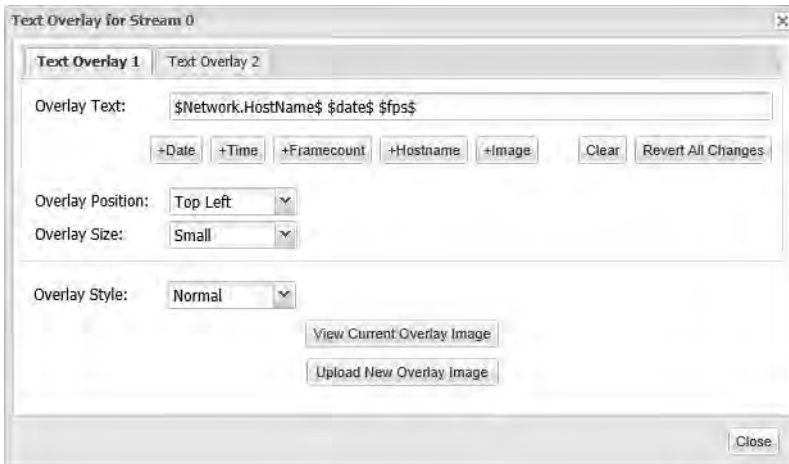

Overlay Text - Sets the text that will appear in the text overlay bar. You can enter simple strings of text, and you can also enter the following expressions:

\$date\$	= display the current date, time, and time zone (see Section 3.11.2 on page 72 to set the current date, time, and time zone and to set the date/time format).
\$timestamp\$	= display timestamp (sec:µsec since 1970).
\$counter\$	= display frame counter.
\$motion\$	= display motion/no motion (no motion = blank space, motion = *).
\$motion_n\$	= display motion/no motion (no motion = blank space, motion = *) in region n.
\$motion_level\$	= display current motion level (number of changed pixels) in region 0.
\$motion_levels\$	= display current motion level (number of changed pixels) in all regions.
\$motion_level_n\$	= display current motion level (number of changed pixels) in region n.
\$frame_size\$	= display the width and height of the sensor AOI.
\$frame_position\$	= display the left offset and top offset for the sensor AOI.
\$alarm\$	= display if an alarm condition has been declared (no alarm = blank space, alarm = *).
\$alarm_nr\$	= display alarm number (if any).

\$fps\$	= display the current frame rate for this stream.
\$cpu\$	= display the load on the camera's CPU.
\$SysInfo.ModelName\$	= display the camera's model name.
\$SysInfo.FirmwareVersion\$	= display the camera's firmware version info.
\$SysInfo.ManName\$	= display the camera vendor's name.
\$SysInfo.Serial\$	= display the camera's serial number.
\$SysInfo.MACAddress\$	= display the camera's MAC address.
\$System.DateTimeFormat\$	= display the current date/time format setting.
\$Network.RxTraffic\$	= display the current incoming network traffic level in kilobits/s.
\$Network.TxTraffic\$	= display the current outgoing network traffic level in kilobits/s.
\$Network.HostName\$	= display the host name of the camera.
\$image\$	= display an overlay image in the current stream.

Overlay Position - Sets the position of the text overlay bar.

- **Top Left** = Place the text overlay bar at the top left of each streamed image.
- **Bottom Left** = Place the text bar at the bottom left of each image.
- **Top Right** = Place the text overlay bar at the top right of each streamed image.
- **Bottom Right** = Place the text bar at the bottom right of each image.

Overlay Size - Sets the size of the text in the overlay.

- **Small** = The text in the overlay will be 10 point type.
- **Medium** = The text in the overlay will be 15 point type.
- **Large** = The text in the overlay will be 20 point type.
- **Scaled** = The text in the overlay will be scaled to 1/15 of the stream AOI height.

Note that if the text overlay is longer than the image width, the trailing edge of the overlay will be truncated.

Overlay Style - Sets the style of the overlay. This parameter applies across both overlays. If you choose "Black" for overlay 1, the style for overlay 2 will also be "Black".

- **Normal** = The overlay will display black text on a white background bar.
- **Inverted** = The overlay will display white text on a black background bar.
- **White** = The overlay will display white text with no background bar.
- **Black** = The overlay will display black text with no background bar.

+Date - Click the **+Date** button to quickly enter the `$date$` expression into the **Overlay Text** line.

+Time - Click the **+Time** button to quickly enter the `$timestamp$` expression into the **Overlay Text** line.

+Framecount - Click the **+Framecount** button to quickly enter the `$counter$` expression into the **Overlay Text** line.

+Hostname - Click the **+Hostname** button to quickly enter the `$Network.HostName$` expression into the **Overlay Text** line.

+Image - Click the **+Image** button to quickly enter the `$image$` expression into the **Overlay Text** line. For more information on using images in stream overlays, see "Using Images in Stream Overlays" on [page 39](#).

Clear - Click the **Clear** button to clear all of the text from the **Overlay Text** line.

Revert All Changes - Click the **Revert All Changes** button to revert all changes made in the **Overlay Text** line.

View Current Overlay Image - Click the **View Current Overlay Image** button to view the current overlay image in the camera.

Upload New Overlay Image - Click the **Upload New Overlay Image** button to upload a new PNG file as an overlay image for the current stream.

Close - Click the **Close** button to save the changes you have made and close the **Text Overlay** dialog box.

Using Images in Stream Overlays

Apart from text you can also include images in the overlays, e.g. company logos. The images you upload have to meet the following criteria:

- The file format is PNG.
- The maximum file size is 128 kByte. The maximum PNG compression level can be used.
- The image size must not exceed 4 MByte after the image has been unpacked in the camera's memory.

You can display one image per overlay, however, you can only upload one image per stream to the camera. This means that you can display the same image in both overlays of a stream, but not one image in overlay 1 and a different image in overlay 2.

You can upload different image types. The PNG format supports color or grayscale images with or without a mask as well as black and white images. Please note the following about using images in text overlays:

- If an image has a mask applied, this is always going to be used, even if **Overlay Style** is set to **Normal** or **Inverted**.
- Color and grayscale images are always displayed the same, regardless of the overlay style. They are never displayed inverted.
- Color images can contain a transparent layer.
- In high-resolution streams, color overlay images when combined with a large text size, can have a negative impact on the frame rate.

Black and white images are interpreted as characters which means they can be inverted and are integrated into the background.

Stream AOI Editor - Whenever a stream tab is selected, a **Stream AOI Editor** screen will also be available as shown below.

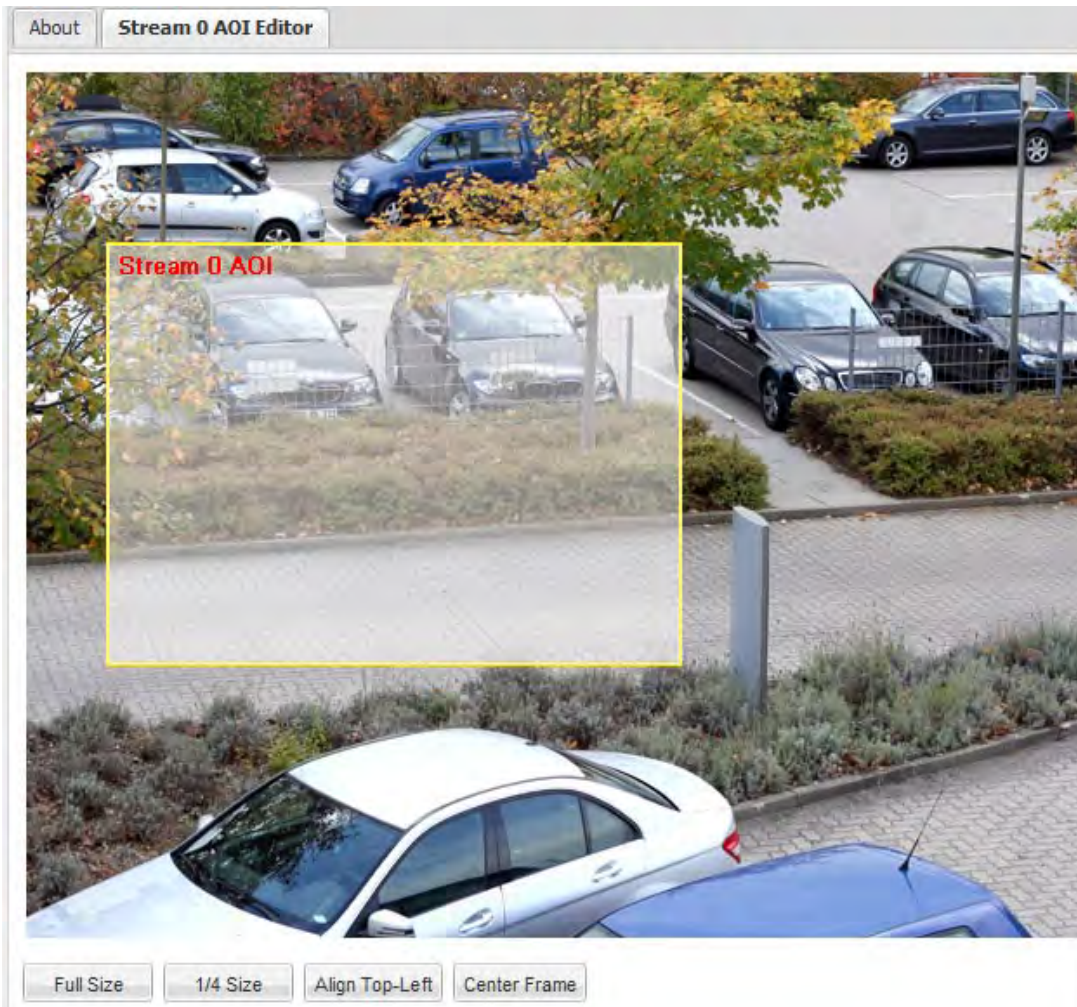

Rather than setting numbers in the boxes on the stream tab, you can use the editor to set the AOI size and position for the stream. To set the stream AOI with the editor, simply use your cursor to drag the edges of the red rectangle that represents the stream AOI. You can also use the buttons at the bottom of the editor to set the stream AOI to the full size of the sensor AOI, to set the stream AOI to 1/4 of the sensor AOI's size, to align the stream AOI to the top left side of the sensor AOI, or to center the stream AOI within the sensor AOI.

When you are working with a stream AOI, remember that the stream AOI must be contained within the sensor AOI. So if you have changed the size or the position of the sensor AOI, this will restrict what you can do with the stream AOI.

Note that the dotted yellow rectangle in the **Stream AOI Editor** shows the current size and position of the sensor AOI.



A stream AOI must be contained within the sensor AOI (see Section 3.4.1 on [page 21](#), Figure 3 on [page 21](#), and Figure 4 on [page 30](#)). If you have decreased the size of the sensor AOI, the allowed settings for the stream AOIs are reduced.

3.5 Motion Detection Parameters

The parameters in the **Motion Detection** group are used to control the operation of the camera's motion detection function.

To understand what the parameters in this group do, you should have a basic idea about how motion detection works:

Just before the camera captures a new image, it takes the last few captured images (from its memory) and uses them to create an averaged image called a "history image".

Immediately after the camera captures a new image, it compares the pixels in the newly captured image with the pixels in the history image. If enough pixels have changed, the camera will determine that motion has been detected.

(When motion detection is enabled, this history image creation/comparison process occurs for each image captured.)

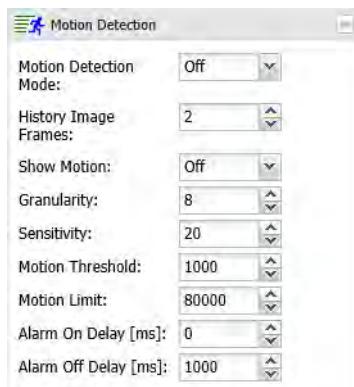

Motion Detection Mode - Enables or disables motion detection.

- **Off** = Motion detection disabled.
- **On** = Motion detection enabled.

History Image Frames - Sets the number of previously captured images that will be used to create the history image. For example, if this value is set to 3, the last 3 captured images will be used to create the history image.

Higher values give better motion detection performance, but they also slow down the speed of the motion detection algorithm and put a greater load on the camera's microprocessor.

Show Motion - Enables or disables the show motion function.

- **Off** = Show motion function disabled.
- **On** = Show motion function enabled. The live image streams displayed in the web client will show large blocks of green pixels in any areas where motion is detected.

Granularity - Sets how many pixels in the current image will be compared to the history image. **1** means that every pixel will be compared, **2** means that every second pixel will be compared, **3** means that every third pixel will be compared, and so on.

Raising the granularity will speed-up the motion detection algorithm and reduce the load on the microprocessor, but increasing it too much means that movement of small objects may be missed.

Sensitivity - Sets the percentage of difference that must be present between a pixel in the current image and the corresponding pixel in the history image for a change in the pixel to be detected. **1** means that the pixels must be 1 % different to detect a change, **2** means that they must be 2 % different, and so on. **With this scheme, a higher setting means less sensitivity.**

Motion Threshold - Sets a threshold for motion detection. If the number of changed pixels in the current image is above the motion threshold and below the motion limit (see the next parameter), then motion will be detected.

Motion Limit - Sets a limit for motion detection. If the number of changed pixels in the current image is above the motion threshold (see the previous parameter) and below the motion limit, then motion will be detected.

Alarm On Delay [ms] - Sets the amount of time (in milliseconds) that continuous motion must be detected in order to declare a motion alarm condition.

Alarm Off Delay [ms] - Sets the amount of time (in milliseconds) that no motion must be detected in order to end a motion alarm condition.

3.6 Alarm Handling Parameters

The parameters in the **Alarm Handling** group are used to select the sources that can declare an alarm condition and to control the actions that will be taken when an alarm condition is declared.

3.6.1 Alarm Sources Section

The alarm sources section of the **Alarm Handling** parameters group is used to select the sources that can declare an alarm condition.

User Trigger Tab

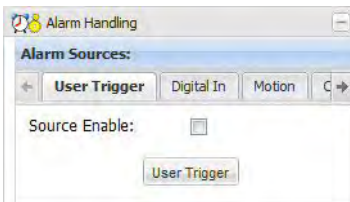

Source Enable - Check the **Source Enable** box on the **User Trigger** tab to enable the user trigger as a source for declaring an alarm condition.

User Trigger - If the user trigger is enabled as an alarm source, you can click the **User Trigger** button to declare an alarm condition.

Digital In Tab

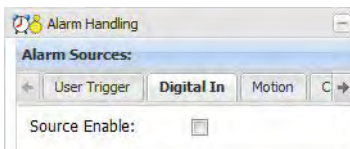

Source Enable - Check the **Source Enable** box on the **Digital In** tab to enable the use of the camera I/O ports as a source for declaring an alarm condition. If a properly configured port becomes active, an alarm condition will be declared.

For this function to work correctly, the **Direction** parameter must be set to "Input" on the I/O port you want to use as a source for declaring an alarm, and the **Function** parameter for that port must be set to "Alarm Trigger" or to "Real-time Trigger". See Section 3.9 on [page 58](#) for more information about setting the camera's I/O port parameters.

Note that more than one port can be set to act as a source for declaring an alarm (i.e., multiple ports could be set to "Input" with the function set to "Alarm Trigger", or one port could be set to "input" with the function set to "Alarm Trigger" and a second port set to "Input" with the function set to "Real-time Trigger"). In this case, checking the **Source Enable** box will allow any one of the properly configured ports to declare an alarm.

Motion Tab

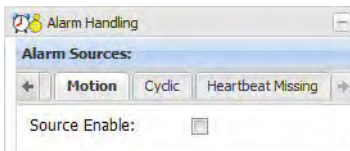

Source Enable - Check the **Source Enable** box on the **Motion** tab to enable motion detection as a source for declaring an alarm condition.

If motion detection is enabled as an alarm source and motion is detected, an alarm condition will be declared.

(In order to use motion detection as an alarm source, motion detection must be enabled. See Section 3.5 on [page 41](#) for more information about motion detection.)

Cyclic Tab

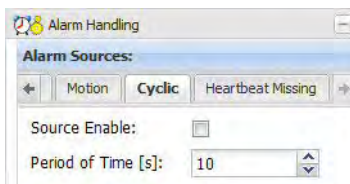

Source Enable - Check the **Source Enable** box on the **Cyclic** tab to enable the cyclic alarm source for declaring recurrent alarm conditions.

A recurrent alarm will be declared after a certain time, that is to be configured in **Period of Time [s]**, has expired.

Period of Time [s] - Sets the time in seconds between two alarm conditions that must expire before a recurrent alarm is declared.

Heartbeat Missing Tab

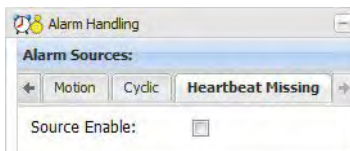

Source Enable - Check the **Source Enable** box on the **Heartbeat Missing** tab to enable the heartbeat missing alarm source for declaring an alarm condition when the heartbeat timeout expires.

Note that the camera's SNMP agent has to be enabled for using the heartbeat missing alarm source (see [page 57](#)).

For basic information on SNMP and the heartbeat functionality, see the description of the SNMP tab on [page 57](#).

3.6.2 Alarm Buffers Section

Each video stream can have an alarm buffer. Normally, the alarm buffer on a stream is simply a ring buffer that stores the last n captured images for the stream (n depends on the size of the images being encoded and the size of the buffer). If an alarm condition is declared, however, the alarm buffer will only continue to buffer post alarm images until the part of the buffer that is allocated for post alarm buffering is full. At that point, buffering will stop, and the pre and post alarm images held in the buffer will be retained until a new **Alarm Buffer Arm** command is issued.

Note that you will only be allowed to arm the alarm buffer if the **Alarm Buffer Size** and **Post Alarm Buffer Size** parameters for the stream have been set to values greater than zero (see [page 35](#)).

Stream 0 Tab



Alarm Buffer State - Indicates the current state of the alarm buffer for stream 0.

- **Off** = The buffer is disabled.
- **Arming** = The buffer is in the process of being armed.
- **Armed** = The buffer is armed and ready to react to an alarm condition.
- **Active** = An alarm condition has been declared and the buffer is actively buffering post alarm images.
- **Done** = The buffer has finished buffering post alarm images and has stopped buffering.

Arm Buffer - Click the **Arm Buffer** button to arm the alarm buffer for stream 0. (If the buffer is in a "done" state, this will arm the buffer and make it begin buffering again.)

Disable Buffer - Click the **Disable Buffer** button to disable the alarm buffer for stream 0.

3.6.3 Alarm Actions Section

The alarm actions section of the alarm handling parameters is used to control the actions that will be taken when an alarm condition is declared.

Digital Output Tab

Alarm Actions:

← Digital Out | Email | HTTP | FTP | →

Action Enable:

Digital Output Hold Time [ms]: 1000

Action Enable - Checking the **Action Enable** box on the **Digital Output** tab enables setting the state of a camera I/O port as an action to take when an alarm condition is declared. If an alarm condition is declared, the port will be set to active.

For this function to work correctly, the **Direction** parameter must be set to "Output" on the I/O port you want to become active when an alarm condition is declared, and the **Function** parameter for that port must be set to "Alarm Announce". See Section 3.9 on [page 58](#) for more information about setting the camera's I/O port parameters.

Digital Output Hold Time [ms] - Sets the amount of time (in milliseconds) that the port will remain active after an alarm condition is declared. If the value is set to zero, the port will remain active as long as the alarm condition remains present.

Email Tab

Alarm Actions:

← Digital Out | Email | HTTP | FTP | →

Action Enable:

Include Image:

Email: jsmith@acme.com

Email Server: acmecorp.mail.com

Email Port: 25

Email User Name: bjones

Email Password:

Email From: camera@\$hostname

Action Enable - Check the **Action Enable** box on the **Email** tab to enable the sending of an email as an action to take when an alarm condition is declared.

Include Image - Check the **Include Image** box to include an image with the email. The included image will be in JPEG format and will be an image that was captured when the alarm was declared.

Note that an image will be included for each JPEG encoded stream (see [page 31](#)) enabled on the camera. If none of the camera's enabled streams are set to JPEG encoding, the **Include Image** check box can't be selected.

Email - Enter an email address for the recipient of the email.

Email Server - Enter an address for the SMTP server that will be used to send the email.

Email Port - Select a port to use on the target email server.

Email User Name - Enter a user name for authentication on the SMTP server. Up to 15 numbers and/or letters (upper or lower case) can be used.

Email Password - Enter a password for authentication on the SMTP server. Up to 29 characters can be used. All standard keyboard characters are valid.

Email From - Enter an email address to appear as the sender's address in the email sent by the camera. You can use the variable \$hostname\$ as part of the address, and the variable will be replaced with the camera's actual host name.

HTTP Tab

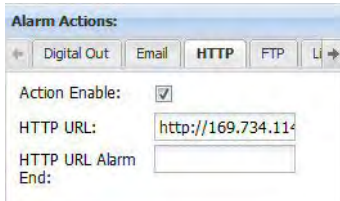

Action Enable - Check the **Action Enable** box on the **HTTP** tab to enable the sending of an HTTP request as an action to take when an alarm condition is declared.

HTTP URL - Enter a valid URL. You could, for example, enter this request: `http://MyServer/cgi-bin/alarm.cgi`

The transmitted string will be URL encoded.

The camera will automatically add the following parameters to the end of the URL:

`host=<hostname>` = The camera's host name, typically something like this: "Basler-20809681"

`date=<date/time>` = The date and time when the alarm has been declared, e.g.:
"2012-01-03 16:30:41 CEST".

(How to set the date and time format and the time zone, see Section 3.11.2 on [page 72](#).)

`ts=<timestamp>` = Time in sec:µsec since 1 Jan 1970, 0:00:00 GMT, when the alarm has been declared, e.g. something like this: "1330342430.625201"

`nr=<alarm number>` = The number of the alarm, e.g. "2".

`Source_User=<boolean>` = If the user is the source that has declared the alarm, the value is set to "1", otherwise to "0".

`Source_PIO=<boolean>` = If the camera I/O ports are enabled as a source for declaring an alarm condition and an active signal becomes present on a camera I/O port, the value is set to "1", otherwise to "0".

`Source_Motion=<boolean>` = If motion detection is enabled as an alarm source and motion is detected, the value is set to "1", otherwise to "0".

`Source_Cyclic=<boolean>` = If the cyclic alarm source has been enabled to declare a recurrent alarm, the value is set to "1", otherwise to "0".

`Source_Heartbeat=<boolean>` = If the heartbeat missing alarm source has been enabled and a heartbeat timeout occurs, the value is set to "1", otherwise to "0".

If motion detection is enabled as an alarm source and motion is detected, the camera will automatically add the following parameters to the end of the above mentioned parameters.

`MotionDetected=<boolean>` = If motion has been detected, the value is set to "1".

`MotionRegion_0=<boolean>` = If motion has been detected in motion detection region 0, the value is set to "1", otherwise to "0".

`MotionLevel_0=<motion level>` = Current motion level (number of changed pixels) in region 0.

The parameter descriptions for the remaining parameters MotionRegion_1/MotionLevel_1 to MotionRegion_4/MotionLevel_4 are identical to the MotionRegion_0/MotionLevel_0 parameter descriptions.

HTTP URL Alarm End - Enter a valid URL. You could, for example, enter this URL:
http://MyServer/cgi-bin/alarm.cgi

The transmitted string will be URL encoded.

The camera will automatically add the following parameters to the end of the URL:

host=<hostname> = The camera's host name, typically something like this: "Basler-20809681"

date=<date/time> = The date and time when the alarm has been declared, e.g.:
"2012-01-03 16:30:41 CEST".

(How to set the date and time format and the time zone, see Section 3.11.2 on [page 72](#).)

ts=<timestamp> = Time in sec:µsec since 1 Jan 1970, 0:00:00 GMT, when the alarm has been declared, e.g. something like this: "1330342430.625201"

nr=<alarm number> = The number of the alarm, e.g. "2".

FTP Tab

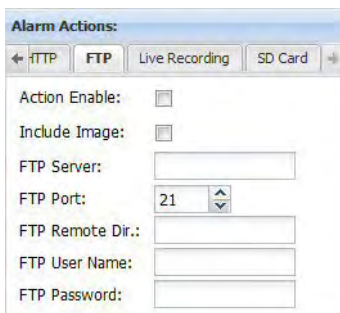

Action Enable - Check the **Action Enable** box on the **FTP** tab to enable the sending of an FTP upload as an action to take when an alarm condition is declared. The upload will be a text file that includes information such as the camera host name and the date and time.

Include Image - Check the **Include Image** box to include an image with the FTP upload. The included image will be a separate JPEG file and will be an image that was captured when the alarm was declared.

Note that an image file will be included for each JPEG encoded stream (see [page 31](#)) enabled on the camera. If none of the camera's enabled streams are set for JPEG encoding, the **Include Image** check box can't be selected.

FTP Server - Enter a valid address for the FTP server that will receive the upload.

FTP Port - Select the port to use on the target FTP server.

FTP Remote Dir - Enter the path to a target subdirectory for the FTP upload. (If no path is specified, the root directory will be used.)

FTP User Name - Enter a user name for authentication on the FTP server. Up to 15 numbers and/or letters (upper or lower case) can be used.

FTP Password - Enter a password for authentication on the FTP server. Up to 29 characters can be used. All standard keyboard characters are valid.

Live Recording Tab

Action Enable - Check the **Action Enable** box on the **Live Recording** tab to enable saving a live stream file to the SD card or to an FTP server as an action to take when an alarm condition is declared.

You can save several enabled streams to the SD card or to an FTP server simultaneously.

Pre-alarm time period [s] - Sets the amount of time in seconds that will be used for saving the data of a live stream before an alarm is declared. A maximum value of 60 seconds can be entered.

The storage requirement in the live buffer for saving pre-alarm data depends on the bitrate of the encoder. To make sure that the live buffer is large enough for saving the determined time of pre-alarm data, the settings of the live buffer size and the alarm buffer size for the selected stream must be tuned carefully. Higher settings for the **Pre-alarm time period [s]** parameter require that the live buffer size is also set to a higher value, which in turn reduces the remaining space available for the alarm buffer. (For information about the live buffer size and the alarm buffer size, see [page 35](#)).

Post-alarm time period [s] - Sets the amount of time in seconds that will be used for saving the data of a live stream after an alarm has been declared. A maximum value of 60 seconds can be entered.

The determined time of post-alarm data has only a minor impact on the storage requirement in the live buffer. Unlike the pre-alarm data, the post-alarm data does not need to be kept temporarily in the live buffer (see the **Pre-alarm time period [s]** parameter). When an alarm is declared, storing post-alarm data only requires as much memory as is needed for buffering the encoder output before it will be saved to the SD card/FTP server.

Live Recording Behavior - Sets the behavior of the live recording alarm action.

Note that this parameter setting will only have an effect if the **Live Recording** parameter is set to **On Alarm** or **Alarm Recording** (see [page 51](#)).

- **During alarm** = Saving the live stream to the SD card or to an FTP server will be started if an alarm condition has been declared and if you have checked the **Action Enable** box on the **Live Recording** tab. Saving the live stream will be stopped as soon as the alarm condition ends.
- **Starting only** = Saving the live stream to the SD card or to an FTP server will be started if an alarm condition has been declared and if you have checked the **Action Enable** box on the **Live Recording** tab. It will, however, not be stopped when the alarm condition ends.
- **Stopping only** = Saving the live stream to the SD card or to an FTP server will be stopped if an alarm condition ends and if you have checked the **Action Enable** box on the **Live Recording** tab. It will, however, not be started automatically when the alarm condition is declared.

SD Card Tab

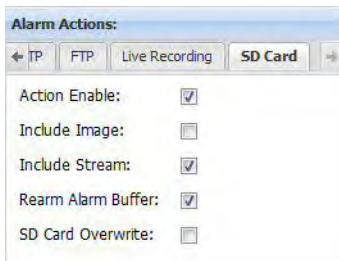

Action Enable - Check the **Action Enable** box on the **SD Card** tab to enable saving a file to the SD card as an action to take when an alarm condition is declared. The file saved to the SD card when an alarm condition is declared will be a text file that includes information such as the camera host name and the date and time.

Include Image - Check the **Include Image** box to save an image file to the SD card along with the text file. The image will be a separate JPEG file and will be an image that was captured when the alarm was declared.

Note that an image file will be included for each JPEG encoded stream (see [page 31](#)) enabled on the camera. If none of the camera's enabled streams are set for JPEG encoding, the **Include Image** check box can't be selected.

Include Stream - Check the **Include Stream** box to save video files to the SD card along with the text file. The video files will contain the pre-alarm and post-alarm images that were saved in the alarm buffers when the alarm condition was declared. A video file will be included for any active stream where the state of the alarm buffer for the stream was "armed" when the alarm condition was declared.

The saved file for each active alarm buffer on an MJPEG encoded stream will have an .mjpeg file extension.

The saved file for each active alarm buffer on an MPEG4 encoded stream will have an .m4v file extension.

The saved file for each active alarm buffer on an H.264 encoded stream will have an .h264 file extension.

Rearm Alarm Buffer - Check the **Rearm Alarm Buffer** box to allow the camera to automatically rearm the alarm buffers after it has successfully finished saving the buffer contents to the SD card.

SD Card Overwrite - Check the **SD Card Overwrite** box to allow the camera to overwrite the oldest files on the card if it is attempting to save files and the portion of the memory space that is currently allocated for alarm data storage is full. This portion is determined by the setting of the **Live Memory Allocation [%]** parameter described on [page 52](#).

For more settings related to the SD card, see [page 52](#).

3.7 Live Recording Parameters

The parameters in the **Live Recording** group are used to configure the settings for saving live recording data to an SD card or to an FTP server.

3.7.1 Stream Tabs

The parameters on the **Stream 0** tab, **Stream 1** tab, and **Stream 2** tab control the way that the live stream associated with the selected tab is saved and to which location it is saved. Several streams can be saved simultaneously.

This section describes the settings on the **Stream 0** tab, the settings available on the **Stream 1** and **Stream 2** tabs are identical to the **Stream 0** tab.

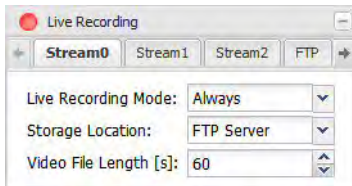

Live Recording Mode - Sets the live recording mode for the stream.

- **Off** = Live recording is turned off. The live stream of the enabled stream will not be saved.
- **Always** = Live recording is always turned on. The live stream of the enabled stream will permanently be saved.

- **On Alarm** = Live recording will be started for the enabled stream if an alarm condition has been declared and if you have enabled the **Live Recording** alarm action (see [page 49](#)).

When the alarm condition is declared, the **Live Recording** parameter automatically changes its value from **On Alarm** to **Alarm Recording**.

Note that the beginning and the behavior of recording the live stream is determined by the **Live Recording Behavior** parameter (see [page 49](#)).

- **Alarm Recording** = Live recording will be started immediately for the enabled stream (regardless of whether the **Live Recording** alarm action (see [page 49](#)) has been enabled or not).

When an alarm condition ends and the **Live Recording** alarm action has been enabled before, the **Live Recording** parameter automatically changes its value from **Alarm Recording** to **On Alarm**.

Note that the behavior of recording the live stream is determined by the **Live Recording Behavior** parameter (see [page 49](#)).

When saving live stream files to the SD card, note the settings entered for **Live Memory Allocation [%]** and **Overwrite Live Recordings** on the **SD Card** tab (see [page 52](#)).

You should be aware that if the load on the camera's microprocessor is already large during normal operation, saving live streams to the SD card or to the FTP server can influence the overall performance of the camera. Also take this fact into consideration if you want to save several streams simultaneously.

Storage Location - Sets the location where the live stream should be saved.

- **SD Card** = The live stream will be saved to an SD card. For information about the SD card settings, see [page 52](#).
- **FTP Server** = The live stream will be saved to an FTP server. For information about the FTP server settings, see [page 53](#).

Video File Length [s] - Sets the maximum length in seconds of an individual live stream video segment saved to the SD card or to the FTP server. The live stream(s) is/are saved in the form of many individual live stream video segments in a raw image format.

Each video segment has a defined length in seconds. Values from 0 to 60 seconds are allowed. Note that for JPEG encoded streams, a value of 0 causes the camera to store single images.

3.7.2 SD Card Tab

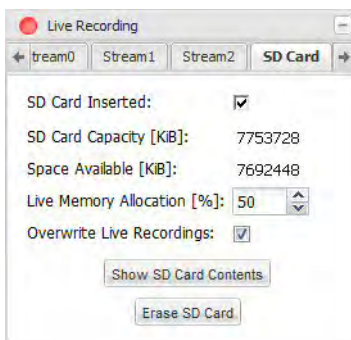

SD Card Inserted - Indicates the presence of an SD card in the camera. If the box is checked, an SD card is inserted. SD cards formatted with an unsupported file system will not be recognized and need to be reformatted (see "Erase SD Card" on [page 53](#)).

SD Card Capacity [KiB] - Indicates the storage capacity of the SD card in kilobytes.

Space Available [KiB] - Indicates the amount of free space available on the SD card in kilobytes.

Live Memory Allocation [%] - Sets the percentage of free space available on the SD card that should be allocated for live stream data storage. The default setting is 50 %. The remaining memory space is used for alarm data storage.

When you adjust this setting, you will notice that it must be changed in fixed increments of 10 %.

Note that if the value of the **Live Memory Allocation [%]** is set to 0 %, recording of live streams to the SD card is effectively turned off. If the value is set to 100 %, however, saving of alarm data to the SD card is effectively turned off.

Overwrite Live Recordings - Check the **Overwrite Live Recordings** box to allow the camera to overwrite the oldest live stream files saved to the SD card if it is attempting to save new files and the portion of the memory space that is currently allocated for live stream data storage is full. This portion is determined by the setting of the **Live Memory Allocation [%]** parameter (see above).

If the box is not checked and the allocated memory space on the SD card is full, the live stream(s) will not be saved.

Show SD Card Contents - Click the **Show SD Card Contents** button to access the SD card's file structure via an FTP server that is built into the camera. When you click the button, the browser will open a new window, will connect to the camera via the FTP server, and will display the root level file structure for the SD card. The browser functionality will allow you to navigate through the SD card's file structure and to download files from the SD card.

Erase SD Card - Click the **Erase SD Card** button to erase the contents of the SD card. If the SD card cannot be accessed at the file system level, it will be reformatted. This is a method to make SD cards formatted with an unsupported file system accessible.

When you click the button, an **Are you sure?** window will open. Click the **Yes** button in the **Are you sure?** window to complete the erase operation, or click the **No** button to cancel the erase operation.

ERASING THE SD CARD IS AN UNRECOVERABLE OPERATION!

3.7.3 FTP Tab

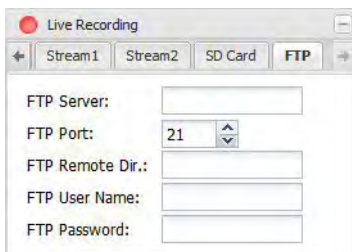

The screenshot shows a software window titled "Live Recording" with a tabbed interface. The "FTP" tab is selected. It contains the following fields:

- FTP Server: [Text input field]
- FTP Port: [Dropdown menu showing 21]
- FTP Remote Dir.: [Text input field]
- FTP User Name: [Text input field]
- FTP Password: [Text input field]

FTP Server - Enter a valid address for the FTP server that will receive the upload of the live stream(s).

FTP Port - Select the port to use on the target FTP server.

FTP Remote Dir. - Enter the path to a target subdirectory for the FTP upload of the live stream(s). (If no path is specified, the root directory will be used.)

FTP User Name - Enter a user name for authentication on the FTP server. Up to 15 numbers and/or letters (upper or lower case) can be used.

FTP Password - Enter a password for authentication on the FTP server. Up to 29 characters can be used. All standard keyboard characters are valid.

3.8 Network Parameters

The parameters in the **Network** group are used to set the camera's IP configuration.

3.8.1 Settings Tab

Zero Configuration - Check the **Zero Configuration** box to enable the camera to acquire a dynamic IP address in the 169.254.0.0/16 IP subnet, which is reserved for networking within the local network.

By default, the **Zero Configuration** box is checked.

DHCP - Check the **DHCP** box to enable camera IP addressing via a DHCP server. Note that if this box is checked, the parameter settings for **IP Address**, **Network Prefix**, and **Gateway** will be grayed out.

Host Name Source - Determines the way the host name parameter will be set.

- **DHCP** = The camera receives the host name setting from a DHCP server response, if available.
- **Manual** = You must manually set the host name.

Name Server Source - Determines the way the name server parameter will be set.

- **DHCP** = The camera receives the name server setting from a DHCP server response, if available.
- **Manual** = You must manually set the name server.

IP Address - Assigns an IP address to the camera that will be used if DHCP addressing is disabled.

Network Prefix - If DHCP is disabled, specifies the number of bits which represent the netmask for your network. For example: 16 = 255.255.0.0 or 24 = 255.255.255.0

Gateway - Sets the network gateway that the camera will use if DHCP is disabled.

Host Name - Assigns a host name to the camera if DHCP addressing is disabled or the **Host Name Source** parameter is set to **Manual**. Only letters, digits, and dashes are allowed. No spaces or periods are allowed. (If DHCP addressing is enabled, the host name may be overwritten by the DHCP server.)

Name Server - Sets the name server that the camera will use if DHCP addressing is disabled or the **Name Server Source** parameter is set to **Manual**. Multiple name servers can be defined, which have to be separated by a space.

Search Domain - Sets the domain names the camera will use for resolving non-fully qualified host names via DNS lookups. Multiple domain names can be defined, which have to be separated by a space.

HTTP Port - Sets the HTTP port on which the web interface will listen.

Commit - Click the **Commit** button to save any changes you have made to the network settings.

Revert - Click the **Revert** button to cancel any changes you have made to the network settings. The settings will revert to what they were the last time that the **Commit** button was clicked.

3.8.2 RTSP Tab

Enabled - Check the **Enabled** box to enable the Real Time Streaming Protocol (RTSP). RTSP is a control protocol that allows the camera to negotiate which transport protocol to use for the video streams. Typically, RTSP streaming should be enabled.

RTSP Port - Sets the port that will be used by RTSP. The default port is 554.

Multicast - Check the **Multicast** box to enable multicast streaming. Multicasting is a bandwidth conserving technology. It reduces bandwidth by allowing the camera to deliver a single video stream to multiple recipients on the network. Note that multicasting will only work for streams where the **Encoder Type** parameter (see Section 3.4.2 on [page 30](#)) is set to MPEG4 or to H.264.

Multicast On-Demand - Check the **Multicast On-Demand** box to make the multicast stream an "on-demand" stream. When multicast streaming on-demand is enabled, the camera will only deliver a multicast video stream when one or more devices are requesting the multicast stream. This is an additional bandwidth-reducing mechanism.

Multicast Stream - If multicast streaming is enabled, you can set which one of your streams you want to use for multicasting.

Multicast Metainfo - If multicast streaming is enabled, check the **Multicast Metainfo** check box to add the SEI NAL header before each frame when using H.264 multicast streaming.

Multicast IP - If multicast streaming is enabled, sets the IP address for multicast streaming. The Multicast IP address must be in the range from 224.0.1.0 to 239.255.255.255.

Multicast Port - If multicast streaming is enabled, sets the port for multicast streaming.

Multicast TTL - If multicast streaming is enabled, sets the multicast Time-To-Live (TTL). The multicast Time-To-Live (TTL) value specifies the number of routers (hops) that multicast traffic is permitted to pass through before expiring on the network.

Commit - Click the **Commit** button to save any changes you have made to the RTSP settings.

Revert - Click the **Revert** button to cancel any changes you have made to the RTSP settings. The settings will revert to what they were the last time that the **Commit** button was clicked.

3.8.3 QoS Tab

The parameters on this tab are used to set network traffic prioritization settings, commonly known as QoS or Quality of Service settings. Note that these settings will only have an effect on networks where all network switches and routers support QoS.

Normally, these settings should only be adjusted by a network administrator.

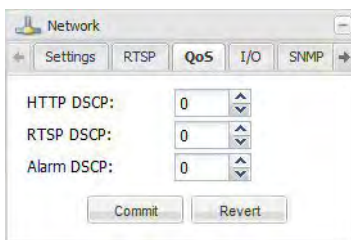

HTTP DSCP - Sets the HTTP DSCP (differentiated services code point) value.

RTSP DSCP - Sets the RTSP DSCP (differentiated services code point) value.

Alarm DSCP - Sets the alarm DSCP (differentiated services code point) value.

Commit - Click the **Commit** button to save any changes you have made to the QoS settings.

Revert - Click the **Revert** button to cancel any changes you have made to the QoS settings. The settings will revert to what they were the last time that the **Commit** button was clicked.

3.8.4 I/O Tab

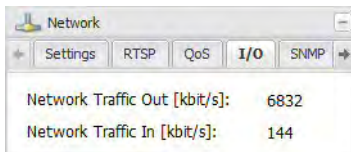

Network Traffic Out [kbit/s] - Indicates the current amount of outgoing network traffic in kilobits per second.

Network Traffic In [kbit/s] - Indicates the current amount of incoming network traffic in kilobits per second.

3.8.5 SNMP Tab

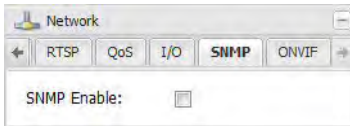

SNMP Enable - Check the **SNMP Enable** box to enable the camera's SNMP agent.

This agent is used to receive information via the Simple Network Management Protocol (SNMP) from a "manager", e.g. an external SNMP server. In this scenario, the SNMP server tells the camera that it is still available (heartbeat functionality). For this purpose, the server sends a heartbeat timeout value ("kick") to the SNMP agent in the camera.

If a missing heartbeat is detected by the camera, an alarm condition can be declared. This missing heartbeat is detected by an expired timeout. To use the heartbeat functionality for declaring an alarm condition in the camera, the heartbeat missing alarm source has to be enabled (see [page 44](#)).

3.8.6 ONVIF Tab

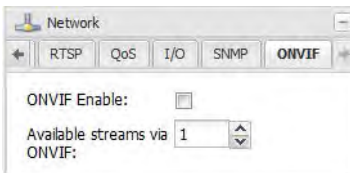

ONVIF Enable - Check the **ONVIF Enable** box to enable the camera for ONVIF support. By default, the ONVIF support is disabled.

Available Streams via ONVIF - Choose the number of ONVIF streams. Depending on your camera model, you can have 1, 2, or 3 streams. If you change this value while ONVIF is enabled, the ONVIF daemon will be restarted. That means that existing connections are going to be interrupted. If you reduce the number of streams, the parameters of the streams that are not used anymore will keep their current values.

All camera models offer ONVIF support based on core specification version 1.02.

The ONVIF (Open Network Video Interface Forum) standard specifies how IP products within video surveillance and other physical security areas can communicate with each other. For further information about the ONVIF standard, please refer to <http://www.onvif.org/>.

3.9 Input / Output Parameters

The parameters in the **Input/Output** group are used to configure the camera's digital I/O ports and to configure the camera's RS-485 serial port.

3.9.1 Digital I/O Tab

I/O Sub-Tabs

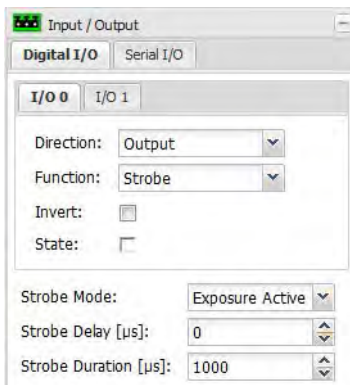

The **Digital I/O** tab includes three sub-tabs. Each sub-tab is used to configure one of the camera's I/O ports. The three I/O ports are designated as I/O 0, I/O 1, and I/O 2.

Each I/O port can be set to act as either an input or an output. The settings on each tab let you specify whether the I/O port associated with the tab will act as an input or an output and let you set the function of the port.

The operation of each sub-tab is identical, and the description below applies to all of the sub-tabs.

(For information about making electrical connections to the I/O ports, see Section 5 on [page 82](#).)

Direction - Sets whether the I/O port will act as an input or as an output.

Function - Sets the function for the I/O port. The list of available functions will be different depending on whether the **Direction** parameter is set to input or output.

If the **Direction** parameter is set to input, the list of available functions will be:

- **Monitor** = The state of the input port can be monitored only (using the **State** check box described below). The camera will not react to any changes in the state of the port.
- **IR Switch** = The input port can be used to control the camera's IR-cut filter. When the port becomes active, the filter will move to the night position (filter not in front of the sensor). When the port becomes inactive, the filter will move to the day position (filter in front of the sensor).
For this function to operate correctly, the **IR Filter Mode** parameter on the **Day/Night** tab (see Section 3.3.3 on [page 16](#)) must be set to "Input Controlled".
- **Alarm Trigger** = The input port can be used to trigger an alarm condition on the camera. When the port becomes active, an alarm condition will be declared.
For this function to operate correctly, the **Source Enable** box must be checked on the **Digital In** tab in the **Alarm Sources** section of the **Alarm Handling** parameters (see [page 43](#)).
- **Real-time Trigger** = The input port can be used to trigger the start of an image exposure. When the port becomes active, an image exposure will begin 7 milliseconds later.
If the **Source Enable** box on the **Digital In** tab in the **Alarm Sources** section of the **Alarm Handling** parameters is checked (see [page 43](#)), an alarm condition will also be declared when the port becomes active.

For more details about the real-time trigger feature, see Section 7 on [page 95](#).

- **External Trigger** = The external trigger function is used to control the exposure start without having to use any other parameters. If the **Function** parameter of an input port is set to "External Trigger" and no external trigger is applied, the camera immediately stops grabbing images.

If this function is used and the **Encoder Mode** parameter is set to "CBR" or "CVBR" (see [page 32](#)), the camera's sensor frame rate has to be set manually via the **Frame Rate Mode** parameter in the **Sensor** group (see [page 22](#)). The reason is that for those two encoder modes, the encoder needs a constant bit rate as input. As this is difficult to achieve with external triggers, which can be applied at irregular intervals, and because the camera does not measure the current frame rate, you have to set a frame rate manually. For the encoder to be able to calculate the desired bitrate for CBR and CVBR correctly, the frame rate mode should be set to the same frame rate as the frequency of the triggers applied externally.

If the **Direction** parameter is set to output, the list of available functions will be:

- **User Output** = You can set the state of the output port by checking or clearing the **State** check box on this tab. When the check box is checked, the port will be active, when the check box is unchecked, the port will be inactive.
- **IR Filter Announce** = The output port will "announce" the position of the camera's IR-cut filter. When the filter is in the night position, the port will be active. When the filter is in the day position, the port will be inactive. (This setting is only available on day/night models of the camera.)
- **Strobe** = The camera will output a pulse on the output port that is synchronized to the start of each image capture. This signal is useful for controlling things such as a strobe exposure lamp. The **Strobe Delay [μs]** and **Strobe Duration [μs]** parameters (see below) are used to adjust the characteristics of the strobe pulse.
- **Alarm Announce** = The output port will "announce" an alarm condition. When an alarm condition is declared, the port will become active. The port will remain active for the time period specified by the **Digital Output Hold Time [ms]** parameter (see [page 46](#)).

For this function to operate correctly, the **Action Enable** box must be checked on the **Digital Output** tab in the **Alarm Actions** section of the **Alarm Handling** parameters (see [page 46](#)).

Invert - Determines whether the operation of the port in regard to being active or inactive will operate normally or be inverted.

- **Unchecked** = The port will operate normally.
- **Checked** = The operation of the port will be inverted.

See Table 3 on [page 84](#) for details about normal and inverted port operation.

State - If the **Direction** parameter (see above) for the port is set to "Input", the **State** check box will be read-only and will indicate the state of the input port. Checked means active and unchecked means inactive.

If the **Direction** parameter (see above) for the port is set to "Output" and the **Function** parameter is set to "User Output", the **State** check box can be used to set the state of the output port. Checking the box makes the port active.

Strobe Mode - If the **Function** parameter is set to "Strobe", the **Strobe Mode** parameter allows you to choose between different ways of controlling strobe lighting because, depending on the model, the strobe requirements of Basler cameras differ. Especially, whether the camera has a rolling or a

global shutter and whether it supports real-time triggering plays an important role. To find out whether your camera falls into one of these categories, refer to the specification tables in Chapter 8 on [page 100](#). For general information about shutters, see Section 3.9.1.1.

- **Flash Window** = This option is only available for cameras with rolling shutters. You can manually adjust the **Strobe Delay** and **Strobe Duration** parameters (see below) in order to control the length of the strobe pulse. For more information, see "Using the Flash Window (Rolling Shutter)" on [page 62](#).
- **Exposure Active** = This option is available for rolling shutter and global shutter cameras. When used with a global shutter camera, you can manually adjust the **Strobe Delay** and **Strobe Duration** parameters (see below) in order to control the length of the strobe pulse. When used with a rolling shutter camera, strobe delay and strobe duration are fixed and can't be changed. For more information, see "Using Exposure Active (Rolling Shutter)" on [page 64](#).
- **RTT Exposure Active** - This option is available for cameras that support real-time triggering. To find out whether your camera offers real-time triggering, check the specification tables in Chapter 8 on [page 100](#). With this setting, a strobe pulse for real-time triggered images only is generated. You can manually adjust the **Strobe Delay** and **Strobe Duration** parameters (see below) in order to control the length of the strobe pulse.

Strobe Delay [μs] - If the **Direction** parameter (see above) for the port is set to "Output" and the **Function** parameter is set to "Strobe", the **Strobe Delay [μs]** parameter sets a delay time (in microseconds) between when image capture starts and when the strobe pulse becomes active.

Note that if multiple ports are set as outputs with their functions set to strobe, the **Strobe Delay [μs]** parameter setting will apply to all of these ports.

Strobe Duration [μs] - If the **Direction** parameter (see above) for the port is set to "Output" and the **Function** parameter is set to "Strobe", the **Strobe Duration [μs]** parameter sets the length of time (in microseconds) that the strobe pulse will remain active.

Note that if multiple ports are set as outputs with their functions set to strobe, the **Strobe Duration [μs]** parameter setting will apply to all of these ports.

3.9.1.1 Differences Between Global and Rolling Shutters

All Basler IP cameras are equipped with imaging sensors that have an electronic shutter. Two types of electronic shutters are used: global and rolling. The following sections describe the differences between them.

Global Shutter

On cameras equipped with a global shutter, exposure begins at the same time for all pixel lines in the sensor.

A main characteristic of a global shutter is that for each frame acquisition, all of the pixels in the sensor start exposing at the same time and all stop exposing at the same time. This means that image brightness tends to be relatively uniform over the entire area of each acquired image, and it helps to minimize problems with acquiring images of objects in motion.

The cameras provide an exposure active output signal that will go active when the exposure time for a frame acquisition begins and will go inactive when the exposure time ends.

Rolling Shutter

On cameras equipped with a rolling shutter, the pixel lines are exposed with a temporal offset (called t_{Row}) from one line to the next. When frame start is triggered, the camera begins exposing the top line of pixels of the AOI (line one). Then, the camera begins exposing line two t_{Row} later. And so on until the bottom line of pixels is reached. See Figure 5. The exposure time is the same for all lines.

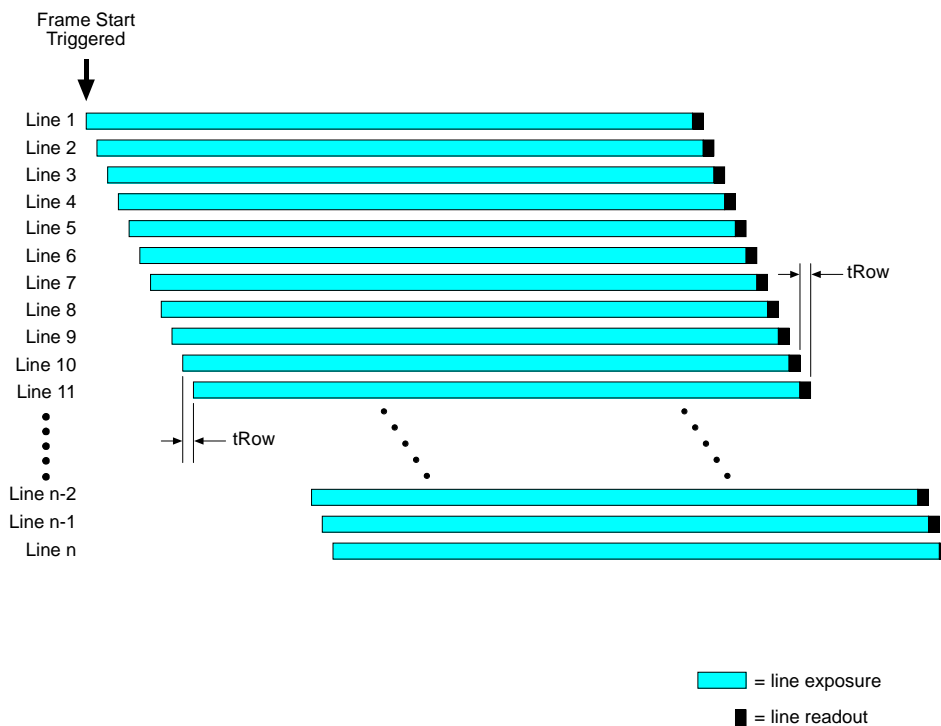

Fig. 5: Rolling Shutter

The use of an additional light source (strobe) is recommended in situations where fast movements are being recorded with rolling shutter cameras as images of fast-moving objects can be blurry otherwise due to the temporal shift in the start of the exposure of the individual lines. There are two ways to trigger this additional lighting:

- Flash Window Signal = triggers a short strobe pulse (= flash).
- Exposure Active Signal = triggers a light source that allows a longer illumination period.

Using the Flash Window (Rolling Shutter)

To provide the best-possible lighting conditions, apply the additional lighting during the "flash window" of each frame. The flash window is the period of time during a frame acquisition when all of the lines in the sensor are being exposed. See Figure 6.

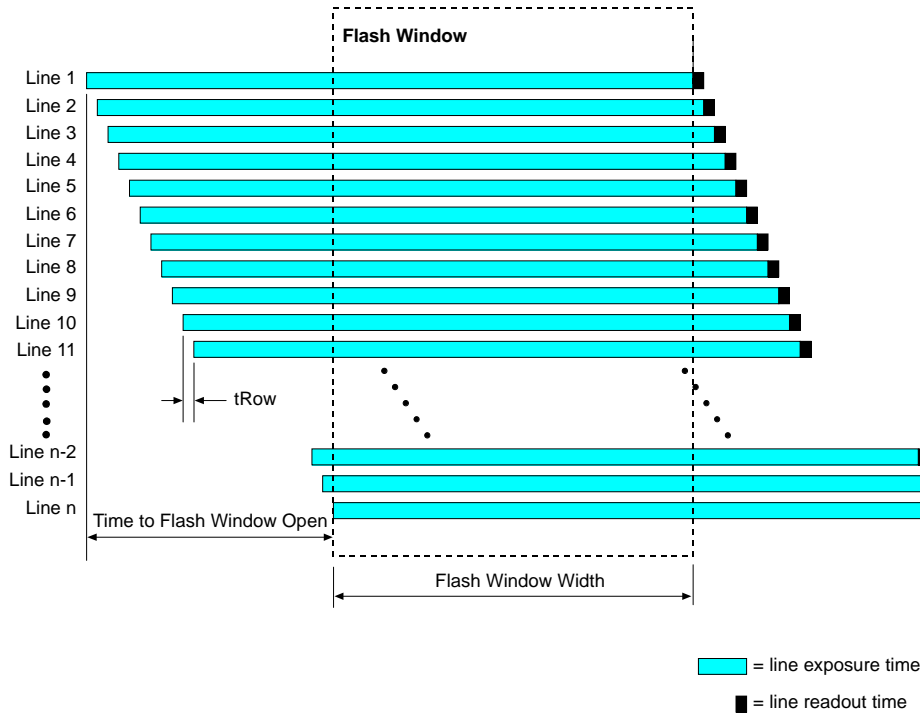

Fig. 6: Flash Window

When the **Strobe Mode** parameter is set to "Flash Window", the camera sends a signal on the digital output port that can be used to trigger a strobe pulse (= flash) in order to provide additional lighting. This signal is called the flash window signal. See Figure 7.

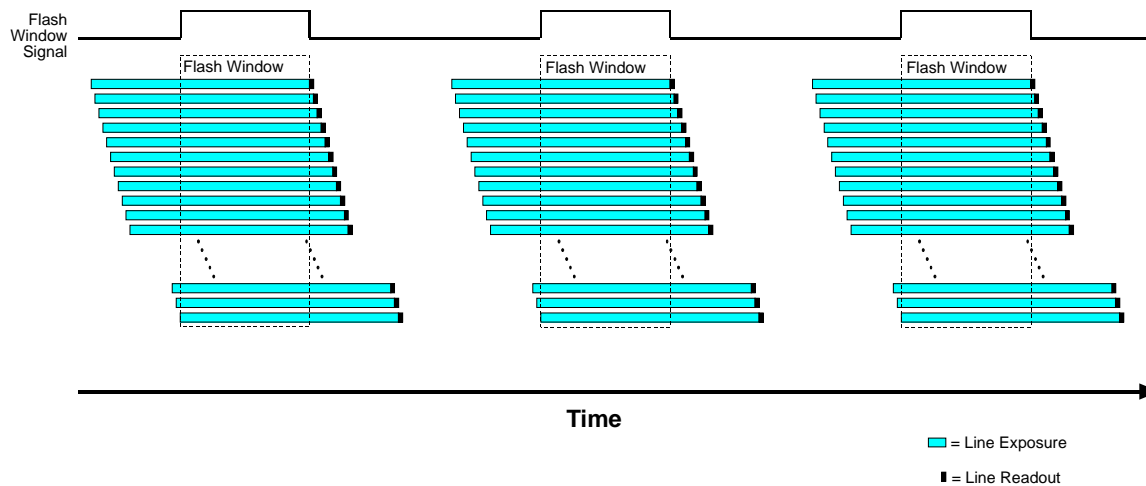

Fig. 7: Flash Window Signal

You can calculate when the flash window will open (i.e., the time from the frame trigger until the moment when the window opens) using the following formula:

$$\text{Time to Flash Window Open} = t\text{Row} \times (H - 1)$$

where

$$H = \text{Sensor Height (user-settable AOI height + 8)}$$

$$t\text{Row} = \text{Camera-specific Value (see Table 1)}$$

You can calculate the flash window width (i.e., how long the flash window will remain open) using this formula:

$$\text{Flash Window Width} = \text{Exposure Time} - t\text{Row} \times (H - 1)$$

To get a flash window at all, the following condition must be true:

$$\text{Exposure Time} > t\text{Row} \times (H - 1)$$

Otherwise, the strobe signal will not become active. To avoid this, it is strongly recommended to use an exposure mode where you can manually set the exposure time.



The flash window signal will never be active outside the flash window. This means that you can only reduce the width of the flash window by either delaying the start of the strobe pulse or by reducing its duration.

Camera Model	tRow
BIP2 - 1280c	29.479166 μs
BIP2 - 1920c	29.479166 μs
BIP2 - 2500c	36.145833 μs

Table 1: tRow of Rolling Shutter Camera Models

Using Exposure Active (Rolling Shutter)

When the **Strobe Mode** parameter is set to "Exposure Active", the camera sends a signal on the digital output port that can be used to control an external light source in order to provide additional lighting, e.g. an LED lamp. This signal is called the exposure active signal.

In this scenario, the exposure active signal is active from the start of exposure of the first sensor row until the end of exposure of the last sensor row. See Figure 8. The **Strobe Delay** and **Strobe Duration** parameters are disabled in this case.

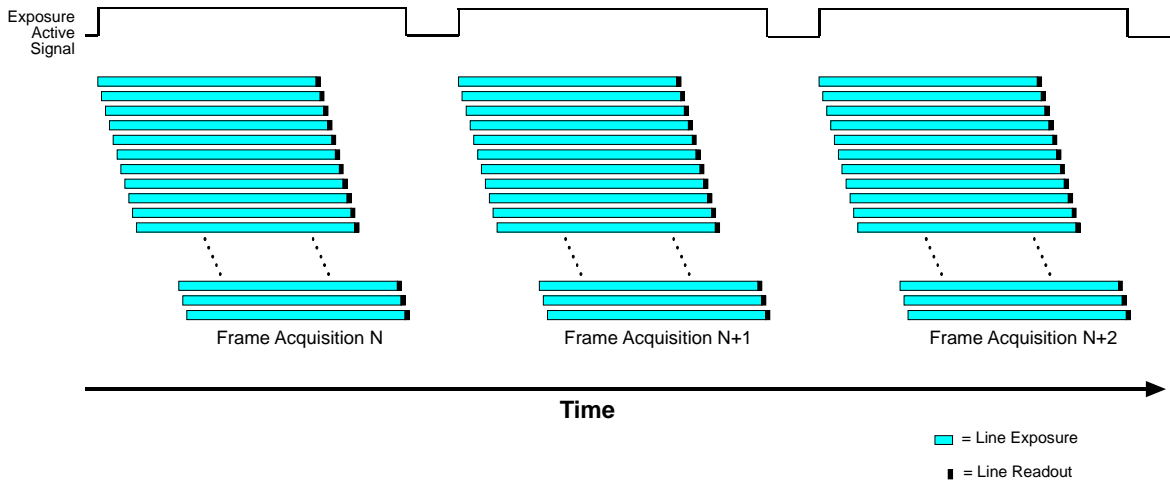

Fig. 8: Exposure Active Signal

3.9.2 Serial I/O Tab

The parameters on the **Serial I/O** tab are used to configure the camera's RS-485 serial port.

The screenshot shows a web-based configuration window for the 'Serial I/O' tab. The window has a title bar 'Input / Output' and two tabs: 'Digital I/O' and 'Serial I/O'. The 'Serial I/O' tab is active. The settings are as follows:

- Forwarding:** A checkbox that is currently unchecked.
- Forwarding Mode:** A dropdown menu set to 'Telnet'.
- Baud Rate:** A dropdown menu set to '9600'.
- Line Configuration:** A dropdown menu set to '8N1'.
- Port:** A dropdown menu set to '15000'.
- Authentication:** A checkbox that is currently unchecked.
- User Name:** A text input field containing the text 'serial'.
- Password:** A text input field with masked characters (dots).

At the bottom of the configuration area is a 'Commit' button.

Forwarding - Check the **Forwarding** box to enable serial port forwarding. When forwarding is enabled, serial commands issued via TCP/IP over the designated port (see the **Port** parameter below) will be forwarded to the serial port.

Forwarding Mode - Sets the mode for serial port forwarding.

- **Telnet** = The network connection behaves like a normal telnet connection using the byte "0xFF" as an escape character for the input of commands.
- **Raw** = Only the data from the serial port is transmitted over the network without any interpretation.

Baud Rate - Sets the baud rate for the serial port (in bits per second).

Line Configuration - Sets the line configuration for the serial port in Data Bits, Parity, Stop Bit format. For example, **8N1** means 8 data bits, no parity, 1 stop bit.

Port - Sets the port to listen to for incoming TCP/IP traffic. If forwarding is enabled, all traffic will be forwarded to the serial port.

Authentication - If the **Authentication** box is checked, then a login will be required to access the serial port.

User Name - Sets the user name for access to the serial port. Up to 15 numbers and/or letters (upper or lower case) can be used.

Password - Sets the password for access to the serial port. Up to 29 characters can be used. All standard keyboard characters are valid.

Commit - Click the **Commit** button to save any changes you have made to the settings.

3.10 User Parameters

The parameters in the **User** group are used to manage user authentication on the camera.

3.10.1 Enabling Authentication and Logging in for the First Time

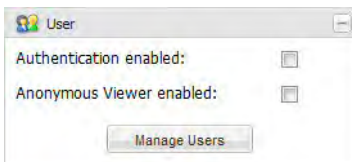

Authentication enabled - Check the **Authentication enabled** box to enable user authentication on the camera. With user authentication enabled, a valid user name and password will be required to access the camera.

When you select the **Authentication enabled** box, you will see a warning window similar to the one shown below. Click **Yes** to enable authentication.

Anonymous Viewer enabled - Check the **Anonymous Viewer enabled** box to enable anonymous access to streams (via HTTP, RTSP) without requiring the user to provide a valid user name and password prior to access.

Anonymous viewers can access streams even if the user authentication is enabled. Streams can be accessed by any appropriate streaming media.

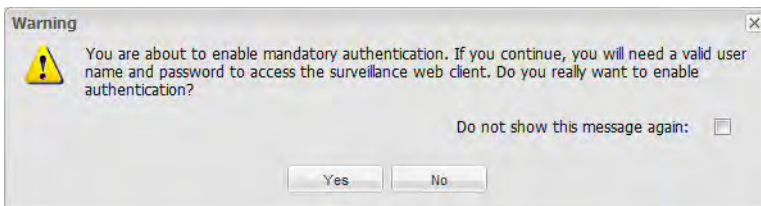

User authentication will become enabled, and a **Please Login** window will appear as shown below.

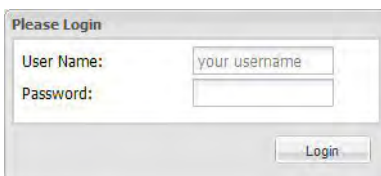

To log in for the first time use the default administrator user name and password (case-sensitive):

User Name: admin

Password: admin



To disable user authentication, make sure that you have logged in as an administrator and clear the **Authentication enabled** box.

3.10.2 Logging In and Logging Out

Once you have logged into the camera, a **Logged in:** indicator, a **Change Password** button, and a **Logout** button (shown circled in red below) will appear in the Basler toolbar.

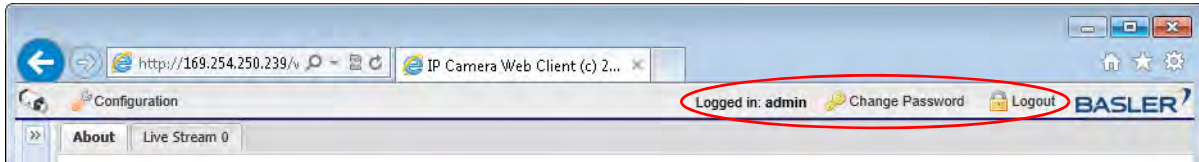

Notice that the **Logged in:** indicator displays the user name of the person who is currently logged into the camera (in this case, the user is named "admin").

Click the **Change Password** button to change the password of the person who is currently logged into the computer. When you click the button, a **User Editor** window will appear as shown below. Enter a valid password, reenter the password to verify, and click the **Save** button.

User names and passwords can include letters, numbers, and underscores (_). **User names and passwords are case-sensitive.**

To log out, simply click the **Logout** button. When you log out, the web browser will gray, and a **Please Login** window will appear as shown below.

To log back in, enter a valid user name and password, and then click the **Login** button.



If you are logged into the camera, refreshing the browser or closing the browser window will not log you out. You will remain logged in until you follow the log out procedure or restart the camera.

3.10.3 Managing Users

To manage users, you must be logged into the camera as an administrator.

Once you are logged in, access the **User** parameters group, and click on the **Manage Users** button. A **User Management** tab will appear as shown below.

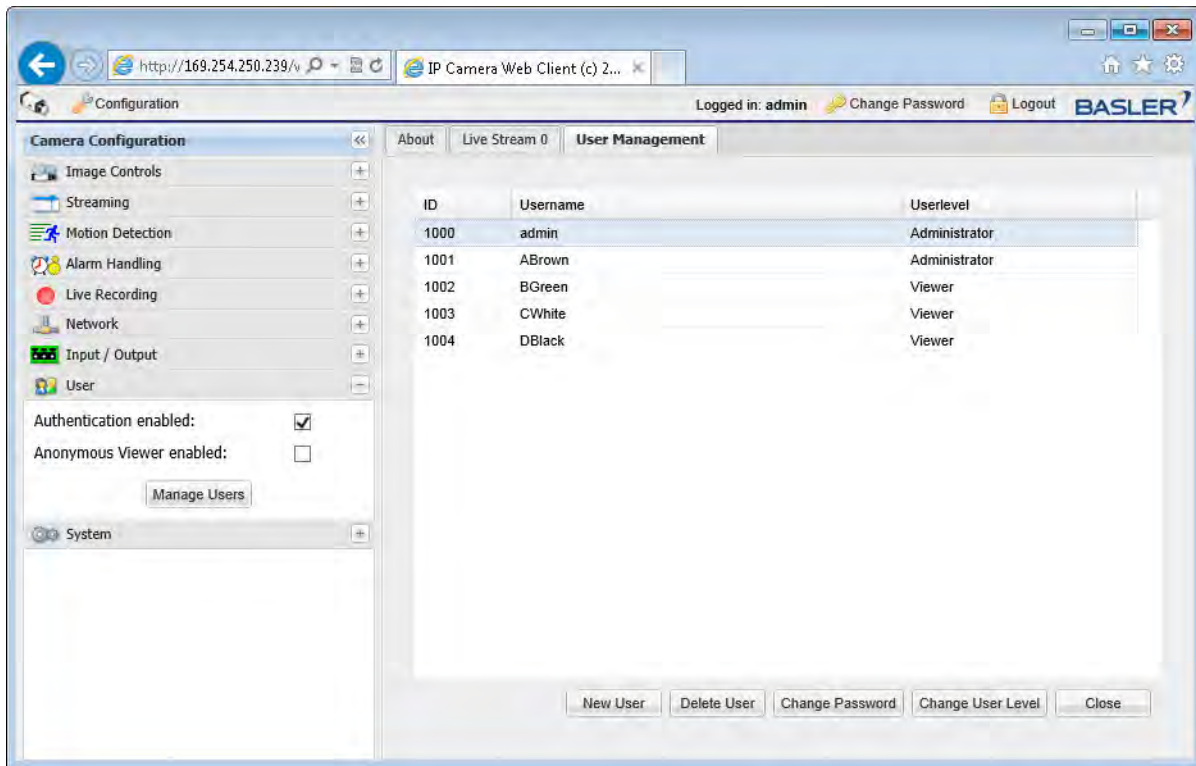

User names can include letters, numbers, and underscores (_). **User names and passwords are case-sensitive.**

The available user levels are described in Table 2.

User Level	Meaning
Administrator	Can change all camera configuration parameters. Can add or delete users. Can change the level or password of all existing users.
Viewer	Can view images and can change his or her own password. Has no access to camera parameters.

Table 2: Available User Levels

To Add a New User

1. Click the **New User** button on the **User Management** tab. A **User Editor** window will appear as shown below.

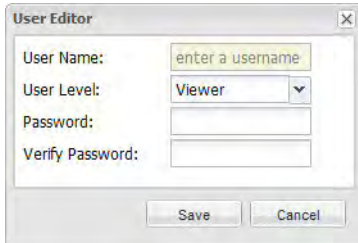

The User Editor dialog box contains the following fields and controls:

- User Name: enter a username
- User Level: Viewer (dropdown menu)
- Password: (text input field)
- Verify Password: (text input field)
- Buttons: Save, Cancel

2. Enter a user name, select a user level (see Table 2 on [page 68](#)), enter a password, reenter the password to verify, and click the **Save** button.
3. A **Success** message window will open. Click the **OK** button.

To Delete an Existing User

1. On the **User Management** tab, click the name of the user you wish to delete. As shown below, the user information will become highlighted, and the **Delete User** button will become available.

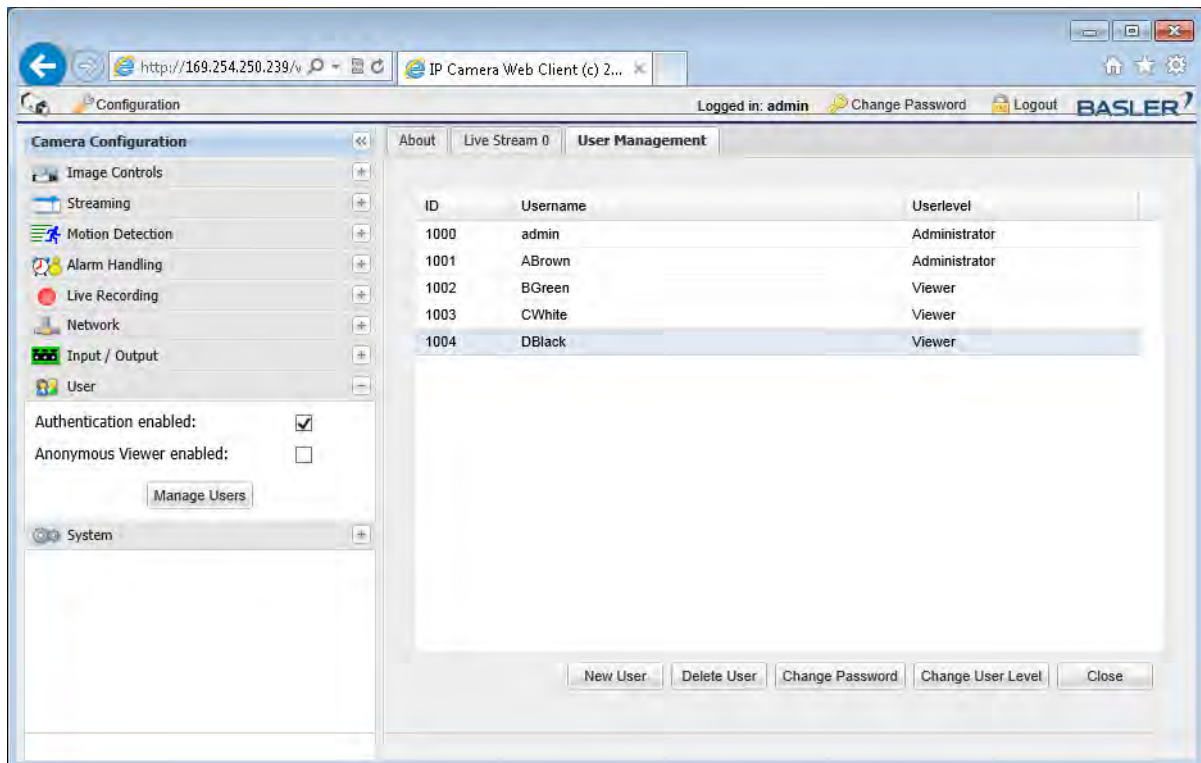

The screenshot shows the IP Camera Web Client interface. The **User Management** tab is active, displaying a table of users. The user with ID 1004 (DBlack) is highlighted. Below the table, the **Delete User** button is visible and enabled.

ID	Username	Userlevel
1000	admin	Administrator
1001	ABrown	Administrator
1002	BGreen	Viewer
1003	CWhite	Viewer
1004	DBlack	Viewer

Buttons at the bottom of the User Management tab: New User, Delete User, Change Password, Change User Level, Close.

2. Click the **Delete User** button.
3. An **Are you sure** message window will open. Click the **Yes** button.
4. A **Success** message window will open. Click the **OK** button.



You must have at least one administrator level user. If there is only one administrator level user, you will not be able to delete that user.

To Change an Existing User's Password

1. On the **User Management** tab, click the name of the user whose password you wish to change. As shown below, the user information will become highlighted, and the **Change Password** button will become available.

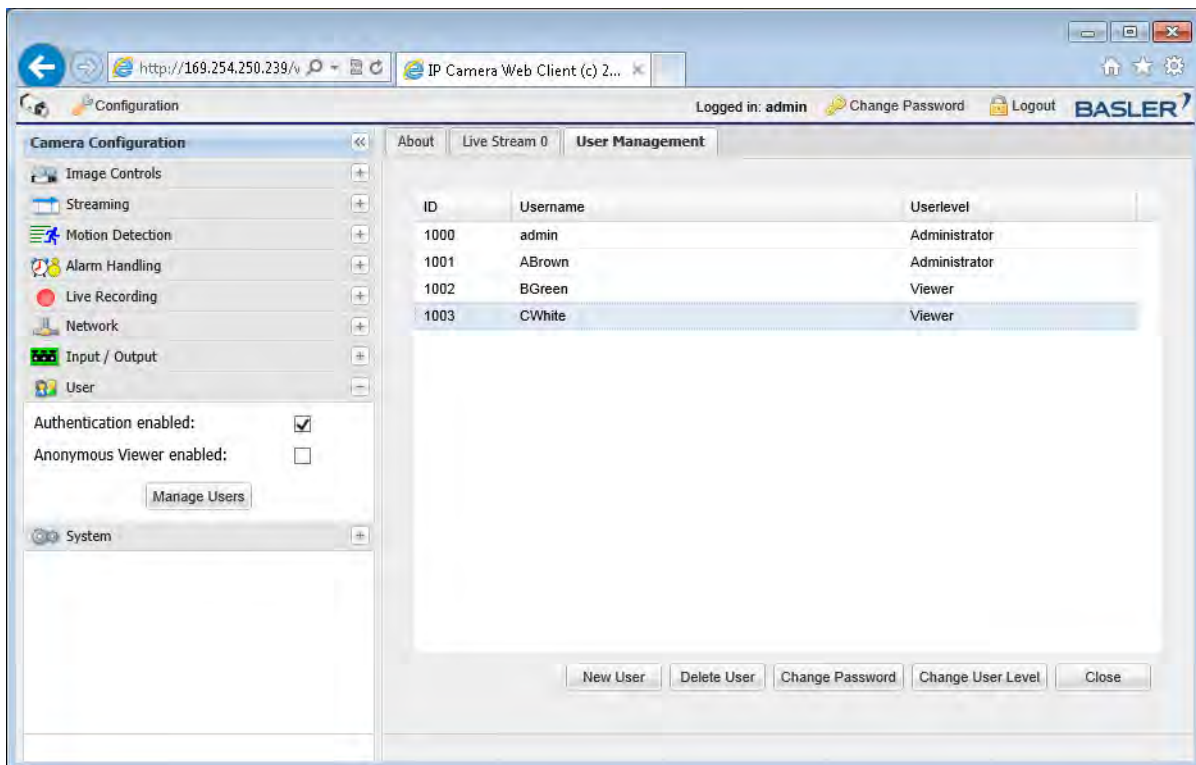

2. Click the **Change Password** button. A **User Editor** window will appear as shown below.

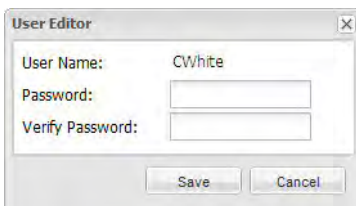

3. Enter a new password, reenter the password to verify, and click the **Save** button.

To Change an Existing User's User Level

1. On the **User Management** tab, click the name of the user whose user level you wish to change (see Table 2 on [page 68](#) for user level descriptions). As shown below, the user information will become highlighted, and the **Change User Level** button will become available.

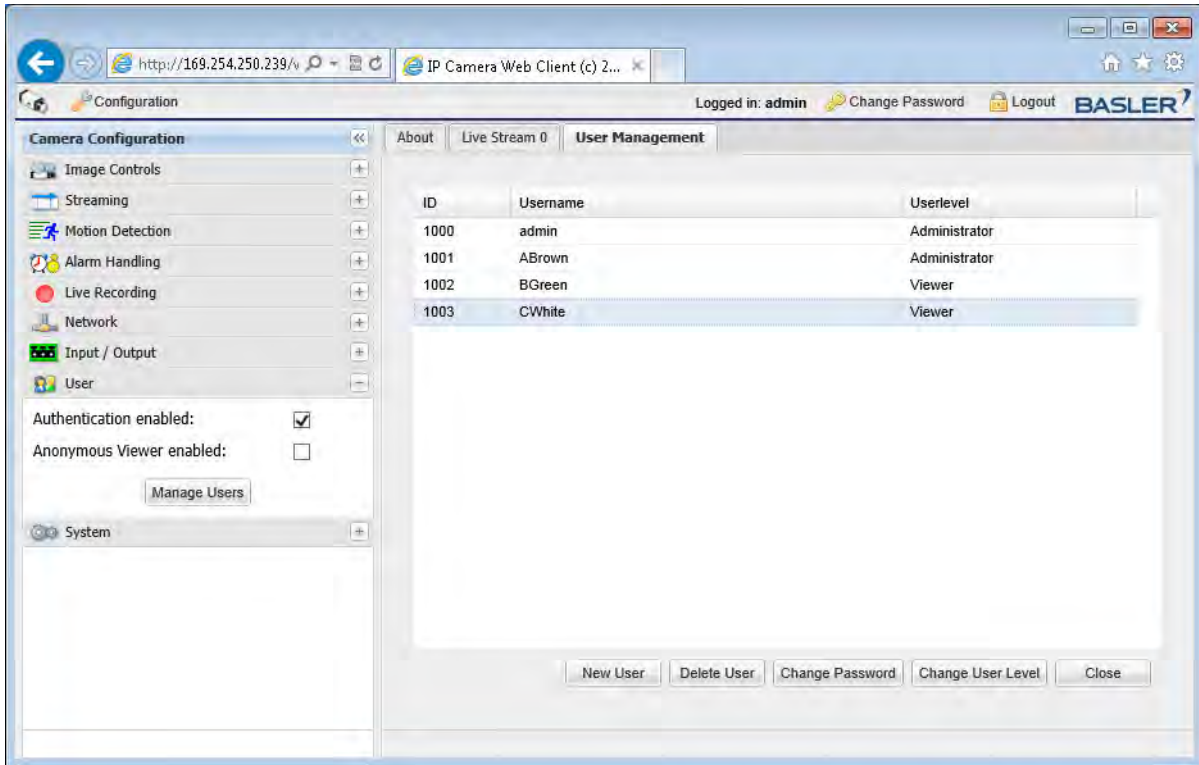

2. Click the **Change User Level** button. A **User Editor** window will appear as shown below.

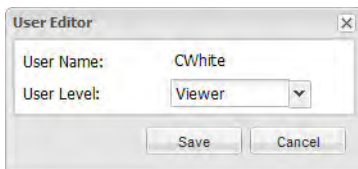

3. Select a new user level from the drop down menu, and click the **Save** button.



You must have at least one administrator level user. If there is only one administrator level user, you will not be able to change that user's user level.

3.11 System Parameters

The parameters in the **System** group provide some basic information about the camera and allow you to set basic system characteristics such as the date and time.

3.11.1 Info Tab

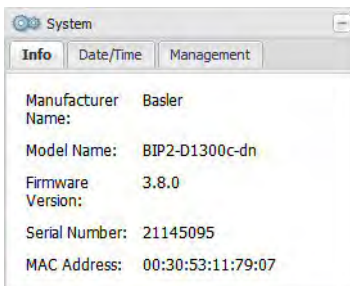

Manufacturer Name - Indicates the name of the camera's manufacturer.

Model Name - Indicates the camera's model name.

Firmware Version - Indicates the version number of the firmware currently installed on the camera.

Serial Number - Indicates the camera's serial number.

MAC Address - Indicates the camera's MAC address.

3.11.2 Date/Time Tab

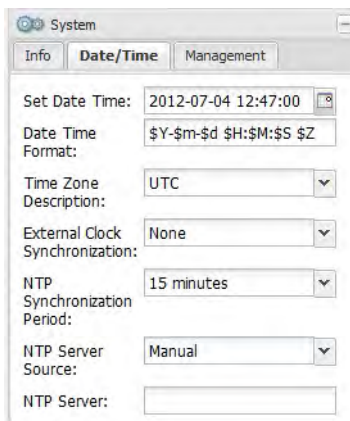

Set Date Time - Sets the date and time that will appear in the text overlay on streamed images (see [page 36](#) for more information about the text overlay). Click the  button to display a calendar that will let you easily set the date and time.

The time is set based on a 24-hour clock.

Date Time Format - Sets the format for the date, time, and time zone entry that will appear in the text overlay on streamed images.

The following symbols can be entered in the Date Time Format box:

\$d = Display the day of the month as a decimal number (i.e., from 01 to 31).

\$D = Same as entering \$m/\$d/\$y.

\$F = Same as entering \$Y-\$m-\$d.

\$h = Display the abbreviated month name.

- \$H = Display the hour as a decimal number using a 24-hour clock (i.e., from 00 to 23).
- \$I = Display the hour as a decimal number using a 12-hour clock (i.e., from 01 to 12).
- \$m = Display the month as a decimal number (i.e., from 01 to 12).
- \$M = Display the minute as a decimal number.
- \$r = Display the time in a.m. and p.m. notation.
- \$R = Display the time in 24 hour notation.
- \$S = Display the seconds as a decimal number.
- \$f = Display the milliseconds as a decimal number.
- \$T = Display the current time, same as entering \$H:\$M:\$S.
- \$y = Display the year without the century as a decimal number.
- \$Y = Display the year as a decimal number.
- \$Z = Display the time zone code if available.

Time Zone Description - Sets the time zone. Select the correct time zone for the camera's location from the drop down list.

External Clock Synchronization - Enables or disables clock synchronization and sets the synchronization method. The BIP2 camera supports clock synchronization using IEEE 1588-2008 (Version 2) PTP specification as well as synchronization with an NTP server. If this parameter is set to "NTP", the synchronization period has to be set using the **NTP Synchronization Period** parameter (see below).

- **None** = No external clock synchronization takes place.
- **NTP Server** = An NTP server is used for clock synchronization.
- **PTP** = Clock synchronization takes place according to PTP specifications.

NTP Synchronization Period - If the **External Clock Synchronization** parameter (see above) is set to "NTP", **NTP Synchronization Period** is used to set the synchronization period.

- **1 minute** = NTP synchronization occurs once every 1 minute.
- **2 minutes** = NTP synchronization occurs once every 2 minutes.
- **4 minutes** = NTP synchronization occurs once every 4 minutes.
- **8 minutes** = NTP synchronization occurs once every 8 minutes.
- **15 minutes** = NTP synchronization occurs once every 15 minutes.
- **30 minutes** = NTP synchronization occurs once every 30 minutes.
- **1 hour** = NTP synchronization occurs once every 1 hour.
- **2 hours** = NTP synchronization occurs once every 2 hours.
- **4 hours** = NTP synchronization occurs once every 4 hours.
- **12 hours** = NTP synchronization occurs once every 12 hours.
- **24 hours** = NTP synchronization occurs once every 24 hours.
- **Weekly** = NTP synchronization occurs once per week.

NTP Server Source - Determines the way the NTP server parameter will be set.

- **DHCP** = The camera receives the IP address or name of the NTP server to use from a DHCP server response, if available.
- **Manual** = You must manually set the IP address or name of the NTP server to use.

NTP Server - Sets the IP address or name of the NTP server to use (NTP synchronization must be enabled) if DHCP is disabled (see "Settings Tab" on [page 54](#)) or the **NTP Server Source** parameter is set to **Manual**. Multiple NTP servers can be defined, which have to be separated by a space.

3.11.3 Management Tab

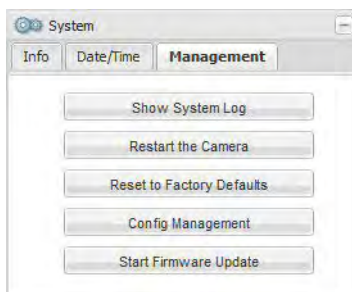

Show System Log - Click the **Show System Log** button to display a log of system messages.

Restart the Camera - Click the **Restart the Camera** button to reboot the camera. When the reboot is complete, the web client will reopen in your browser. Restarting your camera will not change any parameter settings.

Reset to Factory Defaults - Click the **Reset to Factory Defaults** button to reset the camera to factory defaults. Before using this button, be absolutely sure that this is what you want to do.

After you click the **Reset to Factory Defaults** button, you will see an **Are you sure?** message as shown below:

- If the **Keep Network/User Settings** check box is checked, the camera will reset all of the configuration settings except the network settings, the user settings, and the NTP settings.
- If the **Keep Network/User Settings** check box is cleared, the camera will reset all of the configuration settings including the network settings, the user settings, and the NTP settings.

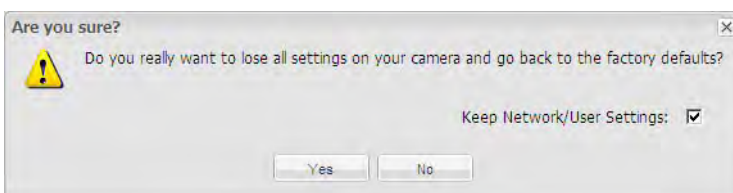

Depending on how your network is configured, if you reset the network settings, you may not be able to access the camera via your web browser after you do the reset. If this is the case, use the Basler BIP Finder software to locate your camera in the network and connect to it as described in the *Basler IP Fixed Box Camera Installation Guide* (AW000975).

Config Management - Use the **Config Management** button to save the camera's current parameter settings to a file on your PC or to upload a saved configuration file from your PC to the camera.

To save the current parameter settings to a configuration file on your PC:

1. Click the **Config Management** button.

A **Configuration Management** dialog box will open.

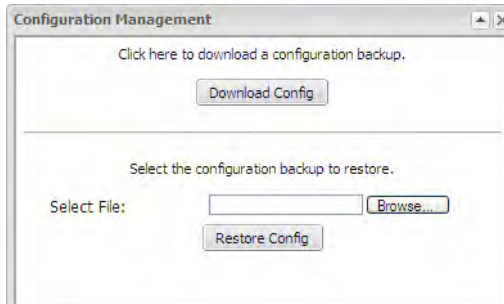

2. Click the **Download Config** button in the **Configuration Management** dialog box.

A **File Download** window will open.



3. Click the **Save** button in the **File Download** window.

A **Save As** dialog box will open.



4. In the **Save As** dialog box, select a location where the file will be saved, enter a file name (Basler recommends using .cfg as the file name extension), and click the **Save** button.
5. When the **Download Complete** screen appears, click the **Close** button.
6. Click the **Close** button in the **Configuration Management** dialog box.

To upload a configuration file saved on your PC to the camera:

When you upload the file, **the parameters in the uploaded file will overwrite the current parameter settings in the camera.**

1. Click the **Config Management** button.
A **Configuration Management** dialog box will open.

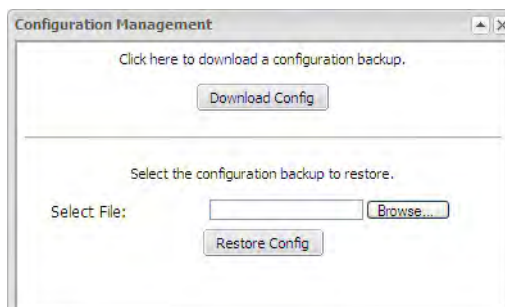

2. Click the **Browse** button in the **Configuration Management** dialog box.
A **Choose File** dialog box will open.

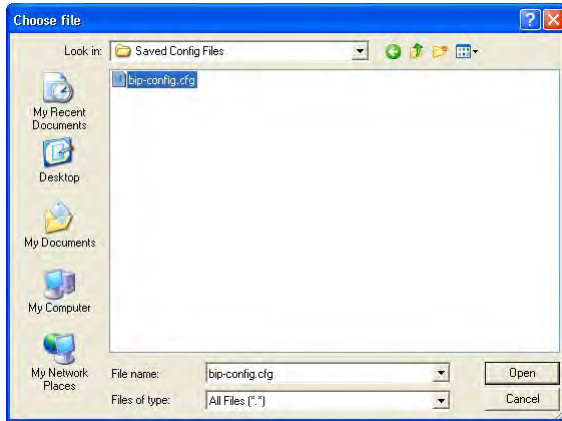

3. In the **Choose File** dialog box, navigate to the location of the saved file, select the file, and click the **Open** button.
4. Click the **Restore Config** button in the **Configuration Management** dialog box.
5. The file will be uploaded from the PC to the camera. When the **Are you sure?** message window appears, click the **Yes** button.
6. The parameters in the file will be applied to the camera and the web client will restart. When the restart is done, the procedure is complete.

Start Firmware Update - Occasionally, firmware updates may be made available to the field. The **Start Firmware Update** button is used to start the firmware update process.

To determine the version of the firmware currently in your camera, access the **Info** tab (see [page 72](#)).

To see if a new firmware version is available, go to the Basler website:
www.baslerweb.com/firmware

If newer firmware is available, download it to your computer.



The Basler IP Camera Finder software (version 1.7 or higher) can also be used to update the firmware. An advantage of the BIP Finder software is that it can be used to simultaneously update multiple cameras.

On camera models with firmware version 3.8.0 or higher updating the firmware with the BIP Finder software only works with the BIP Finder version 1.7 or higher.

You can download the BIP Finder software at: www.baslerweb.com/BIP_finder

NOTE: DO NOT DISCONNECT THE CAMERA FROM POWER OR FROM THE NETWORK WHILE THE UPDATE IS IN PROGRESS. If you disconnect power or the network connection during the update, the firmware update will fail, the camera will no longer operate, and the camera will not be repairable in the field.

To update firmware of your camera:

Once you have downloaded a new firmware update file from the website, you can update the firmware of your camera by following this procedure:

1. Click the **Start Firmware Update** button.
A **Start Firmware Upload** dialog box will open.

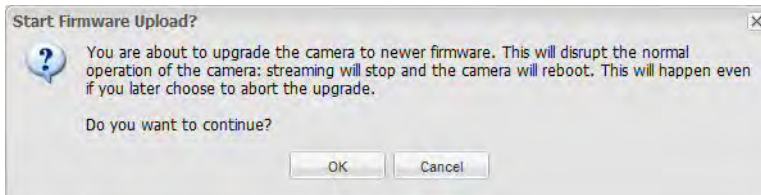

2. Click the **OK** button in the **Start Firmware Upload** dialog box.
A web page will open indicating that camera operation has been stopped.



3. Use the **Browse** button in the window to select the new firmware file that you want to load onto the camera and then click the **Start Firmware Upload** button.
A web page will open asking you to verify that the firmware is correct for the camera.



4. Make sure that the firmware is correct and then click the **Confirm Update** button. A web page indicating the progress will appear. Wait for the update to finish.

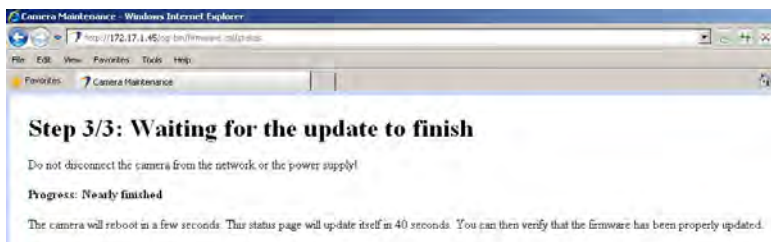

A web page will appear indicating that the update is finished.



5. Click the **Return to Basler Web Client** button to return to the Basler IP Camera Web Client.



If your browser times out during the update process, press the Ctrl and F5 keys (at the same time) to refresh the browser.

If you accidentally close the browser during the firmware update, wait several minutes and then reopen the browser. The update will be performed even with the browser closed.

4 Factory Default Button

A factory defaults button is available on the back of the camera as shown below. The factory defaults button is especially useful if you have enabled user management on the camera and you can no longer remember your administrative password. Using the button resets all of the camera's parameters to factory defaults. **ALL STORED SETTINGS - INCLUDING THE NETWORK SETTINGS - WILL BE LOST.**

Depending on how your network is configured, you may not be able to access the camera via your web browser after you set the camera to the defaults. If this is the case, use the Basler BIP Finder software to locate your camera in the network and to connect to it as described in the *Basler IP Fixed Box Camera Installation Guide (AW000975)*.

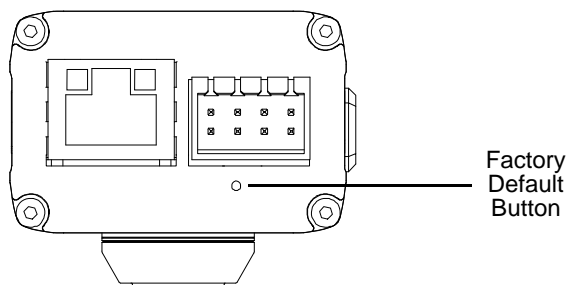

To use the factory default button:

1. Obtain a plastic stylus or similar non-conductive device that you can use to press the button.
2. Remove power from the camera.
3. Press and hold the default button.
4. Apply power to the camera while continuing to hold the reset button pressed.
5. After you have applied power, continue to hold the reset button pressed for about five seconds.
6. Release the reset button.
7. Wait approximately one minute for the camera to finish the reset process and to reboot.

5 The Terminal Connector

The 8-pin terminal connector on the back of the camera can be used to:

- provide power to the camera (when PoE is not used)
- access the camera's I/O ports
- access the camera's RS-485 connection

The terminal connector on the camera is a Weidmüller header (part number 1807480000).

The recommended mating connector is an 8-pin Weidmüller plug (part number 1727650000). A Weidmüller plug of this type is shipped with each camera.

NOTICE

Do not apply AC voltages or voltages outside of the specifications to the camera.

1. Apply only DC voltages. Applying AC voltages can seriously damage the camera.
2. Make sure that the voltages are within the limits specified in Table 3 on [page 84](#). Applying voltages outside of the specifications can seriously damage the camera.

NOTICE

Electrostatic discharge (ESD) can damage electronic components.

Make sure that the black, 8-pin Weidmüller plug that is included with the camera is always inserted into the terminal connector on the back of the camera. This protects the camera from damage caused by electrostatic discharge.

The pin numbering and pin assignments for the terminal connector are as illustrated below.

The pin assignments are described in more complete detail in Table 3 on [page 84](#).

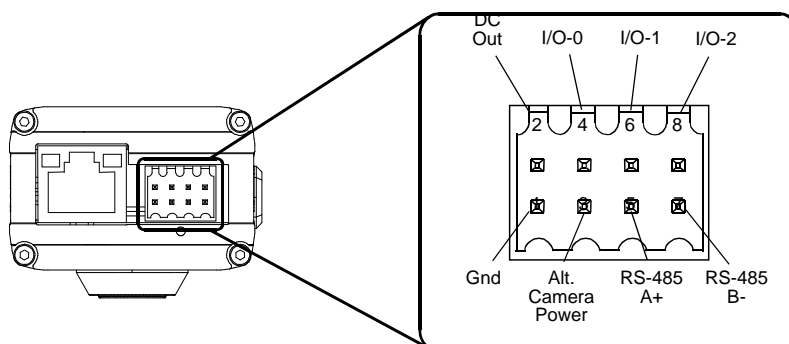

Fig. 9: Terminal Connector Pin Numbering

When inserting wires into the Weidmüller plug that mates with the terminal connector, you must use the technique described in Figure 10. The spring clamps used to hold the wires in the plug are exceptionally strong, and you must use this technique to properly insert wires.

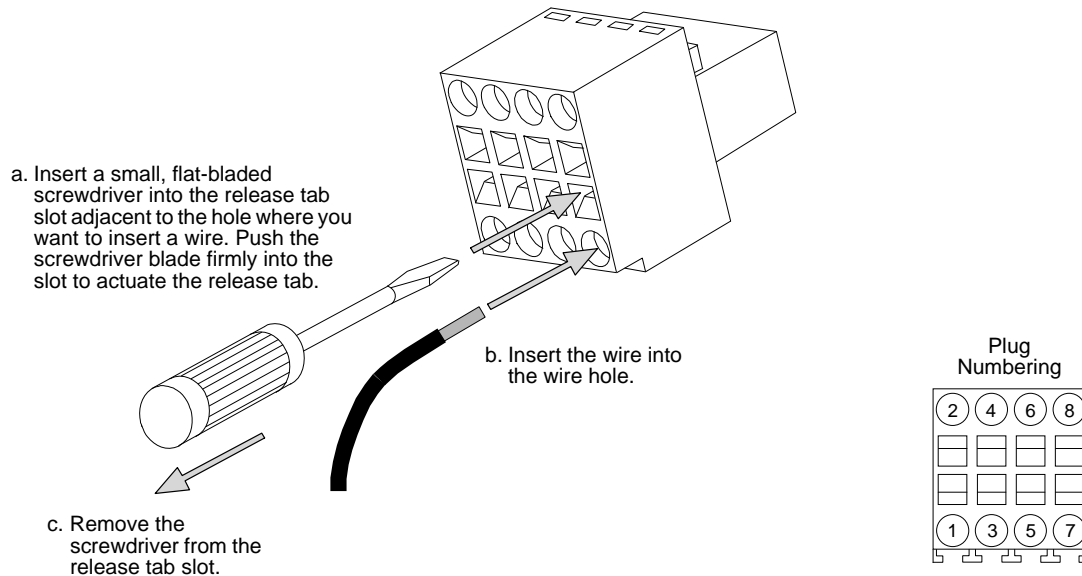

Fig. 10: Wire Insertion Method

Make sure that any wires you insert have the following characteristics:

- A minimum cross section of 0.08 mm^2 (AWG 28) and a maximum cross section of 1.0 mm^2 (AWG 18). Either stranded or solid wire can be used.
- 7 mm (1/4") of insulation has been stripped from the end of the wires.
- Ferrules (end terminals) are not required for stranded wires, but can be used if desired. If the wire ends have ferrules applied, the ferrule must have a cross section between 0.13 mm^2 (0.005") and 0.34 mm^2 (0.013").



Basler recommends that I/O port connections be made with shielded cable and that the cable shields be connected to ground. If you are unable to connect the cable shields to ground or if you use unshielded cable, the maximum length of the I/O port connections is limited to 10 m to avoid electromagnetic interference.

Pin	Function	Description																														
1	Ground	Description: Ground for camera power, I/O-0, I/O-1, I/O-2, and the RS-485 serial port.																														
2	DC Out	DC Out supplies +5.0 VDC and can be used to power a small device as illustrated in Figure 11 on page 86 . The maximum allowed load on DC Out is 100 mA. If an inductive load such as a relay is used with DC Out, a diode must be connected in parallel with the load.																														
3	Alternate Camera Power	Use this pin to supply power to the camera (if you are not supplying camera power via PoE). Nominal operating voltage: +12 VDC Allowed voltage range: +12 to +24 VDC (± 10%) Maximum power consumption: 5 W																														
4, 6, 8	I/O-0, I/O-1, I/O-2 respectively	<p>Each I/O port can be set to operate either as an input or as an output. The choice of whether a particular I/O port will operate as an input or an output and how it will function is made by setting camera parameters (see Section 3.9.1 on page 58 for details).</p> <p>For any I/O port set as an input:</p> <p>Variant 1 (input port connected to ground via a switch):</p> <p>In Figure 11 on page 86, I/O-2 has been set to operate as an input. Normally, you will connect an input port to ground via a switch as illustrated in the figure.</p> <p>As indicated in the table below, an input port will be detected by the camera as active or inactive depending on whether the switch is open or closed and whether the port is or is not set to invert.</p> <p>See Section 3.9.1 on page 58 for more information about setting a port to invert.</p> <table border="1"> <thead> <tr> <th>Switch Condition</th> <th>Port Set To Invert</th> <th>Input Detected As</th> </tr> </thead> <tbody> <tr> <td>Open</td> <td>No</td> <td>Inactive</td> </tr> <tr> <td>Closed</td> <td>No</td> <td>Active</td> </tr> <tr> <td>Open</td> <td>Yes</td> <td>Active</td> </tr> <tr> <td>Closed</td> <td>Yes</td> <td>Inactive</td> </tr> </tbody> </table> <p>Variant 2 (input port connected to an input voltage):</p> <p>You can also connect an input voltage (0 to 24 VDC) to the I/O port as illustrated in Figure 12 on page 87. An input port will be detected by the camera as active or inactive depending on the applied voltage value and on whether the port is or is not set to invert.</p> <table border="1"> <thead> <tr> <th>Input Voltage</th> <th>Port Set To Invert</th> <th>Input Detected As</th> </tr> </thead> <tbody> <tr> <td>0 to +1.15 VDC</td> <td>No</td> <td>Active</td> </tr> <tr> <td>+3 to +24 VDC</td> <td>No</td> <td>Inactive</td> </tr> <tr> <td>0 to +1.15 VDC</td> <td>Yes</td> <td>Inactive</td> </tr> <tr> <td>+3 to +24 VDC</td> <td>Yes</td> <td>Active</td> </tr> </tbody> </table> <p>(Pin 4, 6, 8 description continued on next page.)</p>	Switch Condition	Port Set To Invert	Input Detected As	Open	No	Inactive	Closed	No	Active	Open	Yes	Active	Closed	Yes	Inactive	Input Voltage	Port Set To Invert	Input Detected As	0 to +1.15 VDC	No	Active	+3 to +24 VDC	No	Inactive	0 to +1.15 VDC	Yes	Inactive	+3 to +24 VDC	Yes	Active
Switch Condition	Port Set To Invert	Input Detected As																														
Open	No	Inactive																														
Closed	No	Active																														
Open	Yes	Active																														
Closed	Yes	Inactive																														
Input Voltage	Port Set To Invert	Input Detected As																														
0 to +1.15 VDC	No	Active																														
+3 to +24 VDC	No	Inactive																														
0 to +1.15 VDC	Yes	Inactive																														
+3 to +24 VDC	Yes	Active																														

Table 3: Terminal Connector Pin Assignments

Pin	Function	Description															
		<p>(Pin 4, 6, 8 description continued from previous page.)</p> <p>For any I/O port set as an output:</p> <p>In Figure 11 on page 86, I/O-0 and I/O-1 have been set to operate as outputs. An output port employs an open collector transistor connected to ground as illustrated in the figure.</p> <p>As indicated in the table below, an output port will or will not be connected to ground via the transistor depending on the state of the port and whether the port is or is not set to invert.</p> <p>See Section 3.9.1 on page 58 for more information about setting a port to invert.</p> <p>Note: If an output port has been set to invert and you restart the camera or you power it off and back on, the port will not invert during the camera bootup process and will return to inverted once the bootup process is complete.</p> <table border="1"> <thead> <tr> <th>Output State</th> <th>Port Set To Invert</th> <th>Output Pin Connected To Ground</th> </tr> </thead> <tbody> <tr> <td>Inactive</td> <td>No</td> <td>No</td> </tr> <tr> <td>Active</td> <td>No</td> <td>Yes</td> </tr> <tr> <td>Inactive</td> <td>Yes</td> <td>Yes</td> </tr> <tr> <td>Active</td> <td>Yes</td> <td>No</td> </tr> </tbody> </table> <p>The maximum load is 100 mA and the maximum voltage is +24 VDC.</p> <p>If an inductive load such as a relay is connected to an output port, a diode must be connected in parallel with the load.</p>	Output State	Port Set To Invert	Output Pin Connected To Ground	Inactive	No	No	Active	No	Yes	Inactive	Yes	Yes	Active	Yes	No
Output State	Port Set To Invert	Output Pin Connected To Ground															
Inactive	No	No															
Active	No	Yes															
Inactive	Yes	Yes															
Active	Yes	No															
5	RS-485 A+	A+ pin for a standard RS-485 connection.															
7	RS-485 B-	B- pin for a standard RS-485 connection.															

Table 3: Terminal Connector Pin Assignments

	<p>By default, the I/O-0 port is set as an output with its function set to user settable and the I/O-1 and I/O-2 ports are set as inputs with their function set to monitor. The explanations in Table 3 and the schematic in Figure 11 assume that you have changed the port settings.</p>
---	---

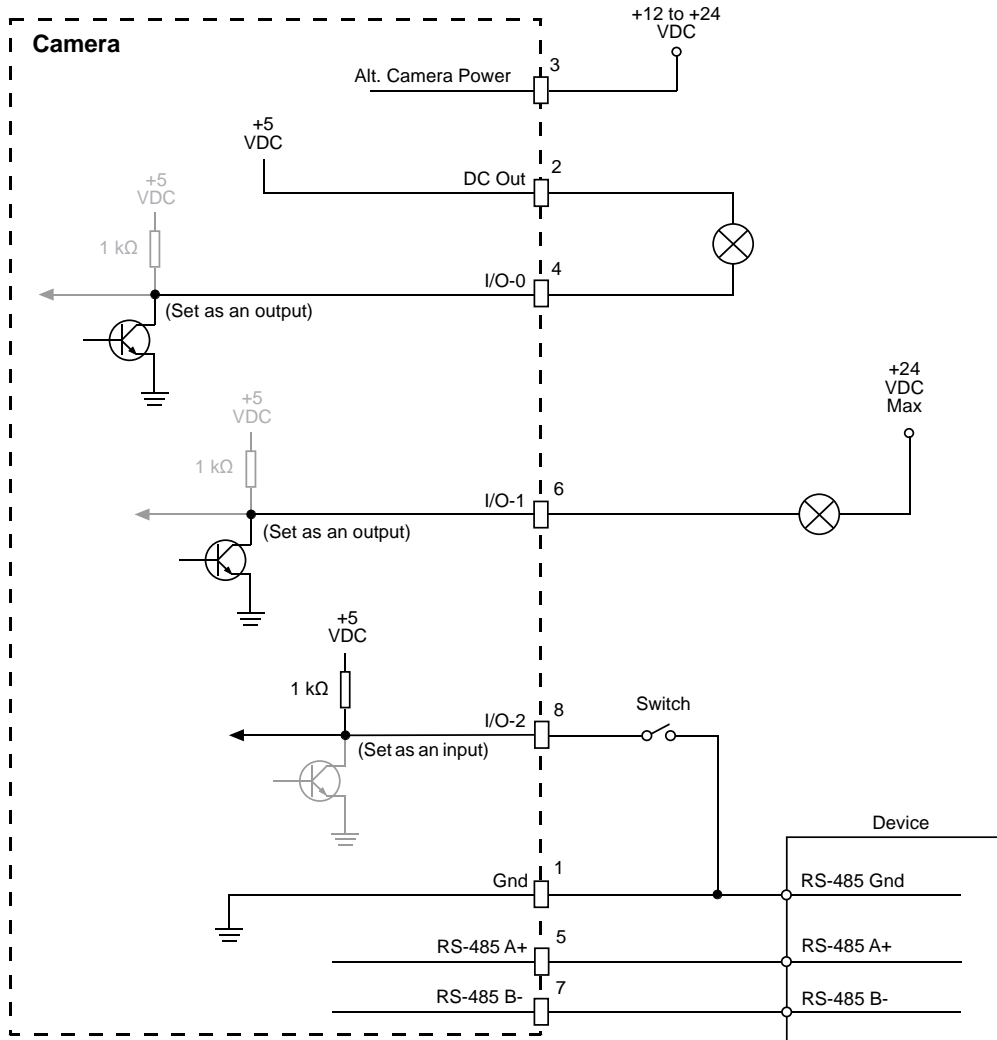

Fig. 11: I/O Schematic, Variant 1 (Input Port Connected to Ground via Switch)

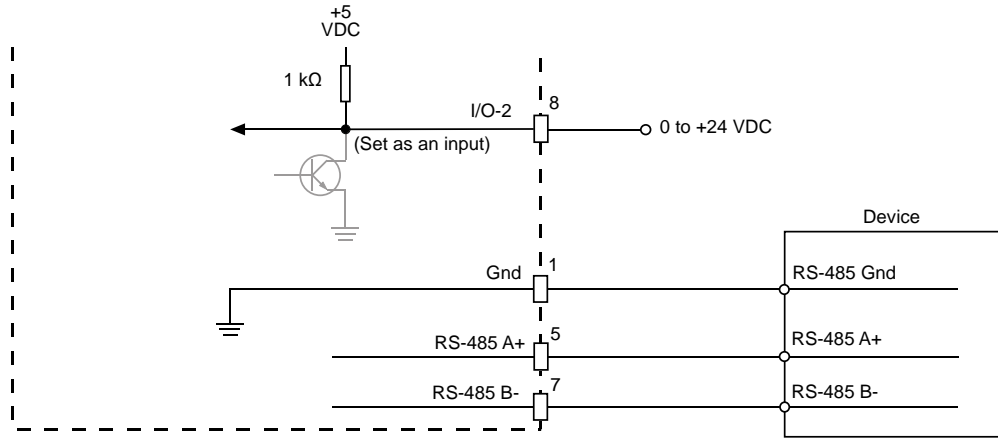

Fig. 12: I/O Schematic, Variant 2 (Input Port Connected to Input Voltage)

6 Day/Night Functionality

6.1 Introduction

Basler IP Cameras with the letters "dn" at the end of the model name (e.g., BIP2-1600c-dn) are equipped with day/night functionality. Cameras with day/night functionality are well-suited for use in areas with natural lighting during the day and artificial lighting at night. And when used with a supplemental IR illuminator, these cameras can produce high-quality images in areas with little visible light, which makes them very useful in applications with poor lighting.

During daylight, a day/night camera delivers color images. As evening approaches and the daylight level decreases, the camera can automatically switch to night mode. In night mode, the camera makes use of near-infrared (IR) light to deliver high-quality black and white images.

Daylight includes both visible light and near-infrared light. Visible light ranges in wavelength from about 400 to 750 nanometers and near-IR light from about 750 to 1000 nanometers. Unlike the human eye, the sensor in color IP cameras is sensitive to both visible light and to near-infrared light. During the daytime, the camera's sensitivity to near-infrared light causes a problem - near-infrared light distorts the colors in the captured images as perceived by the human eye. To avoid this problem, the cameras include an IR-cut filter located in front of the imaging sensor. This filter blocks the near-infrared light present in daylight and ensures proper colors in the captured images.

Day/night cameras include a mechanical mechanism that allows the IR-cut filter to be automatically removed from in front of the sensor. When daylight decreases as evening approaches, the day/night camera senses the change, it goes into night mode, and the internal mechanism in the camera removes the IR-cut filter from in front of the sensor. This allows the camera to use any available near-infrared light to produce black and white images. An IR illuminator that provides infrared light can be placed in the area where the camera is located to enhance its ability to produce high-quality images in low light or in nighttime conditions.

Definitions

When referring to the camera's IR-cut filter:

- the term **night position** means that the mechanical mechanism in the camera has positioned the IR-cut filter so that **it is not** in front of the sensor.
- the term **day position** means that the mechanical mechanism in the camera has positioned the IR-cut filter so that **it is** in front of the sensor.

IR-Cut Filter Modes of Operation

The IR-cut filter mechanism in the camera has several modes of operation. You can use the **Day/Night** tab in the **Image Controls** parameters group (see [page 16](#)) to set the IR Filter Mode. The modes of operation include:

- **Auto** - The camera automatically senses the change from night to day or from day to night. When a day-to-night change is detected, the camera will automatically move the filter to the night position. And when a night-to-day change is detected, the camera will automatically move the filter to the day position (see below for more information on how the auto mode works).
- **Night** - Move the IR-cut filter to the night position (filter is not in front of the sensor) and keep it there.
- **Day** - Move the IR-cut filter to the day position (filter is in front of the sensor) and keep it there.
- **Input Controlled** - The state of one of the camera's I/O ports will control whether the IR-cut filter is in the night or the day position. When the port is active, the filter will be in the night position. And when the port is inactive, the filter will be in the day position. For the input controlled mode to work correctly, the direction on one of the camera's I/O ports must be set to "input", and the port's function must be set to "IR switch". See Section 3.9 on [page 58](#) for more information about setting the camera's I/O ports.

IR-Cut Filter Auto Mode Operation

When the IR-cut filter is set to auto mode, the camera automatically detects the change from day to night or from night to day and positions the IR-cut filter accordingly.

The IR-cut filter auto controls work by monitoring the "darkness level" in the scene that the camera is viewing. If the scene is very dark it will have a high darkness level. And if the scene is very bright, it will have a very low or even a negative darkness level.

As an example, assume that the camera is viewing a daytime scene and that the IR-cut filter is in the day position. Because it is daytime, the darkness level measured by the auto controls will be very low. As night approaches, the scene will become darker and the measured darkness level will gradually rise. Once the measured darkness level rises above a specified "switch level" and remains there for a period of time, the auto controls will assume that it is night and will change the filter to the night position.

Now assume that the camera is viewing a nighttime scene and that the IR-cut filter is in the night position. Because it is nighttime, the darkness level measured by the auto controls will be high. As day approaches, the scene will become brighter and the measured darkness level will gradually fall. Once the measured darkness level falls below the "switch level" and remains there for a period of time, the auto controls will assume that it is day and will move the filter to the day position.

The camera's **IR Filter Switch Level** parameter lets you set the switch level. The higher you set the switch level, the darker it must be before the camera will switch the filter from day position to night position.

The camera's **IR Filter Wait Time** parameter lets you set the time period (in seconds) that the measured darkness level must remain above the switch level before the auto controls will decide that it is nighttime and switch the filter to the night position. The parameter also sets the time period that the measured darkness level must remain below the switch level before the auto controls will

decide that it is daytime and switch the filter to the day position. This parameter helps to keep the auto controls from mistakenly sensing a momentary change in lighting conditions as a change from night to day or from day to night.

Finally, the **IR Filter Current Level** parameter lets you see the current darkness level as measured by the auto controls. Familiarizing yourself with how this value changes when the camera is viewing a dark scene and when it is viewing a bright scene will help you determine where the switch level should be set.

You can use the **Day/Night** tab in the **Image Controls** parameters group (see [page 16](#)) to set the **IR Filter Switch Level** and **IR Filter Wait Time** parameters and to monitor the IR Filter Current Level parameter.

The IR-Cut Filter Announce Feature

The IR-cut filter has a capability called the "announce feature", i.e., the camera can "announce" the current position of the IR-cut filter by setting the state of one of the camera's I/O ports:

- If the IR-cut filter is in the night position, the port will be set to active.
- If the IR-cut filter is in the day position, the port will be set to inactive.

For the IR-cut filter announce feature to work correctly, the direction on one of the camera's I/O ports must be set to "output", and the port's function must be set to "IR Filter Announce". See Section 3.9 on [page 58](#) for more information about setting the camera's I/O ports.

Color Images in Night Mode

In night mode, the camera normally delivers high-quality black and white images as the IR-cut filter is not in front of the sensor and the camera, therefore, can make use of the near-infrared light. If desired, you can also capture color images while in night mode. Note, however, that colors won't be represented accurately in the resulting images.

To capture color images in night mode, you have to use the camera's API as this functionality can't be set via the web client. For more information refer to the *API Description for Cameras with Version 3.x Firmware* (AW000973) manual.

IR-Cut Filter on Camera Models with an External IR-Cut Filter

Some camera models have an external IR-cut filter, e.g. BIP2-1920-30c, which means that there is no automatic switching capability when day/night changes take place. However, you can remove the IR-cut filter manually. To signal to your application whether the filter is present or not, you can use the **IR Filter Mode** parameter on the **Day/Night** tab or the **IRFilterMode** API parameter. Note that the IRFilterAnnounce feature, however, won't be available.

For more information about the using the **IR Filter Mode** tab, see [page 17](#).

For more information about the API parameter, refer to the *API Description for Cameras with Version 3.x Firmware* (AW000973) manual.

6.2 IR-Cut Filter Control Options

Controlling the IR-Cut Filter Position Via a Digital I/O Port

NOTICE

The text in this section and in the illustration shown in Figure 13 are intended as a general description of how you can use an I/O port on the camera to control the IR-cut filter position. Any device or circuit that you attach to an I/O port on the camera must adhere to the specifications provided in Table 3 on [page 84](#).

Using an I/O port in a way that does not meet specifications can result in severe damage to the camera.

As mentioned in Section 6.1 on [page 88](#), the IR-cut filter can be set for several different modes of operation. If you set the IR-cut Filter Mode parameter to "Input Controlled" this will let you control the position of the IR-cut filter (night or day) by inputting a signal into an I/O port on the camera that has been set to act as an input with a function of "IR Switch".

For example, if you set the IR-cut Filter mode to "Input Controlled", you set the Direction parameter for I/O-2 to "input", and you set the Function parameter for I/O-2 to "IR Switch", the port would act as an input and you could use this input to control the position of the IR-cut filter. When the port becomes active, the filter will be moved to the night position. And when the port becomes inactive, the filter will be moved to the day position. (See Section 3.3.3 on [page 16](#) for more information about setting the IR-cut Filter Mode parameter and see Section 3.9.1 on [page 58](#) for more information about setting the digital I/O port parameters.)

At night or in low light situations, you may be using an "IR illuminator" to illuminate the area being viewed by your camera with infrared light. Many IR illuminators include a photocell that detects the change from day to night and from night to day. Often, the photocell in an illuminator will be associated with an internal switch that opens and closes based on the conditions detected by the photocell. As illustrated in Figure 13, an internal switch such as this can be connected to an I/O port on the camera that has been set as described above, and the switch can be used to control the position of the IR-cut filter. In Figure 13, the IR-cut Filter mode is set to "Input Controlled", the Direction parameter for I/O 2 is set to "Input", and the Function parameter for I/O-2 is set to "IR Switch".

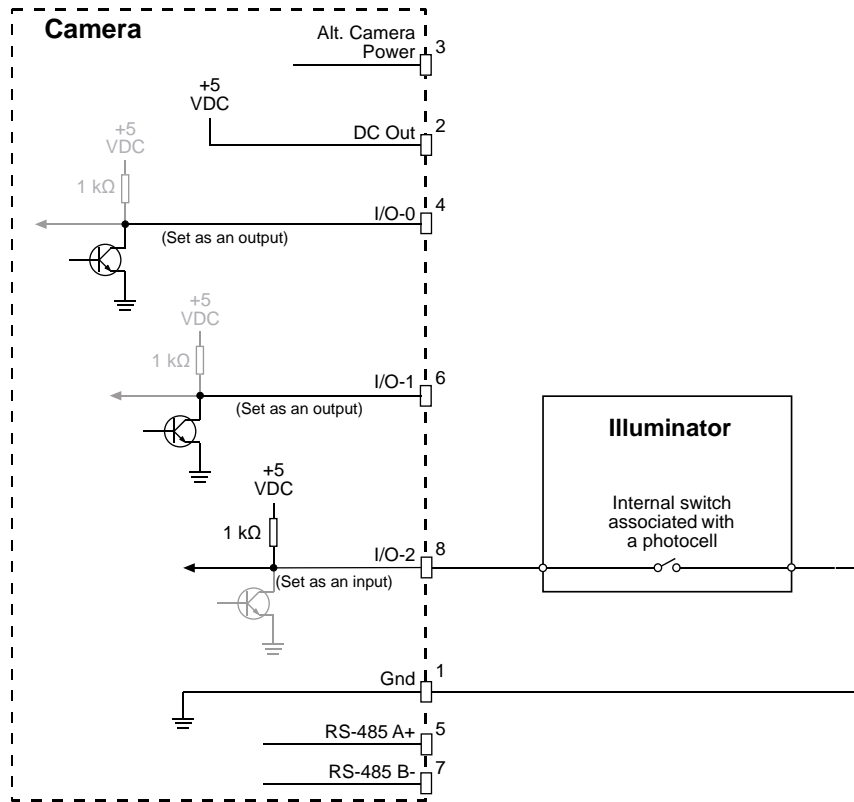

Fig. 13: Input Used to Control IR-Cut Filter Position

Controlling an External Device Based on the IR-Cut Filter Position

NOTICE

The text in this section and in the illustration shown in Figure 14 are intended as a general description of how you can use an I/O port on the camera to control an external device. Any device or circuit that you attach to an I/O port on the camera must adhere to the specifications provided in Table 3 on [page 84](#).

Using an I/O port in a way that does not meet specifications can result in severe damage to the camera.

As mentioned on [page 90](#), the camera includes a capability called the IR-cut filter announce feature. When this feature is enabled, the camera will "announce" the current position of the IR-cut filter by setting the state of an I/O port that has been set to act as an output with a function of "IR Filter Announce".

For example, if you set the Direction parameter for I/O-1 to "Output" and the Function parameter for I/O-1 to "IR Filter Announce", the port would act as an output and the state of the port will "announce" the position of the IR-cut filter. When the IR-cut filter is in the night position, the port will be set to active. And when the IR-cut filter is in the day position, the port will be set to inactive. (See Section 3.9.1 on [page 58](#) for more information about setting the digital I/O port parameters.)

A common way to use this capability is to set the IR-cut Filter Mode parameter to "Auto" mode and to use an I/O port to switch an IR illuminator on and off. Figure 14 shows a simple way that this can be done. In Figure 14, the IR-cut Filter mode is set to "Auto", the Direction parameter for I/O-1 is set to "Output", and the Function parameter for I/O-1 is set to "IR Filter Announce". In the figure, the port is used to energize or de-energize a relay, which in turn applies power to or removes power from an IR illuminator. You could use a setup such as this to apply power to the illuminator when the filter is in the night position at night and to remove power from the illuminator when the filter is in the day position during the day.

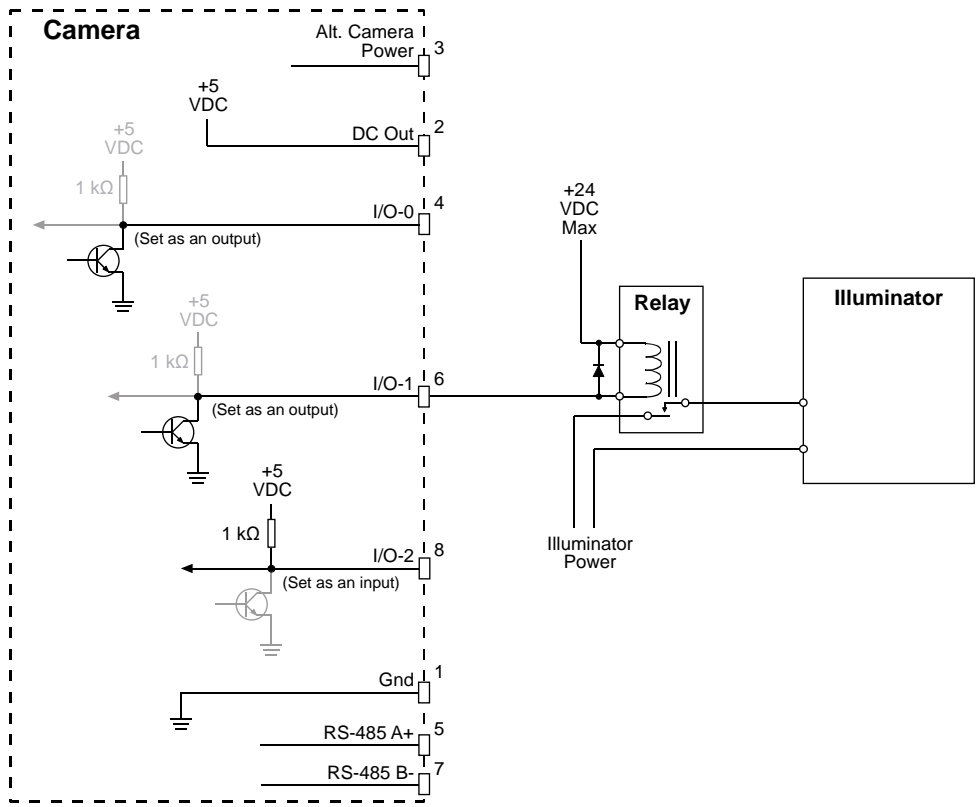

Fig. 14: Output Used to Apply Device Power

7 Real-Time Trigger Functionality

7.1 Introduction

The camera normally captures images without the need for any type of triggering by the user. For instance, if a camera is set for a frame rate of 30 frames (images) per second, it will internally generate all of the required signals needed to initiate the start of an image capture every 1/30 of a second. In this scenario, the user has no control over when the start of any image capture will occur. The camera simply begins each image capture as required to maintain the frame rate.

In many typical surveillance situations, this mode of operation is exactly what the user wants. An automatically captured, continuous stream of images will be perfect, for example, to monitor the actions on a banking floor or a building lobby. In some situations, however, it would be desirable to be able to trigger an image capture at a particular point in time. For example, in a traffic control situation the user might want to trigger an image capture at a particular point in time after a car passes a sensor on a highway.

The real-time trigger feature on the camera guarantees that an image capture will start (i.e., the exposure of an image will start) after a trigger signal is applied to a properly configured I/O port on the camera and an "abort time" period has expired. The abort time for all BIP2 box camera models is seven milliseconds, so an image capture is guaranteed to start seven milliseconds after a real-time trigger signal is applied to a properly configured port on the camera.

Figure 15 on [page 96](#), illustrates the normal image capture process used by the camera. In Figure 15, each yellow bar represents an image capture that is triggered by the camera's internal triggering process. The beginning of the yellow bar represents the point where the camera begins the exposure for an image capture. The end of the bar represents the point where the camera has finished reading the capture image data from the sensor and is ready to transmit the data out of the camera. Because the camera is capturing images at a rate of 30 frames per second, the camera is triggering the start of a new capture every 1/30 of a second. Since the camera is triggering these captures internally, the user has no way of knowing exactly when any of the image captures will start.

Figure 16 on [page 96](#) illustrates how the real-time trigger feature works. When the user applies a trigger signal to the camera, the camera immediately begins to abort any image captures that are currently in progress. This abort process takes 7 milliseconds. At the end of the 7 milliseconds, the camera begins a new image capture (i.e., it starts the exposure for a new image). When the capture process for the real-time triggered image is complete, the image will be transmitted from the camera. The user can be sure that the exposure for this image started exactly 7 milliseconds after the real-time trigger signal was received by the camera.

At some point after the abort process ends, the camera will revert to its normal internal method of triggering the start of image capture. In the case of this example, this will happen 1/30 of a second after the end of the abort because the camera is operated at 30 frames per second.

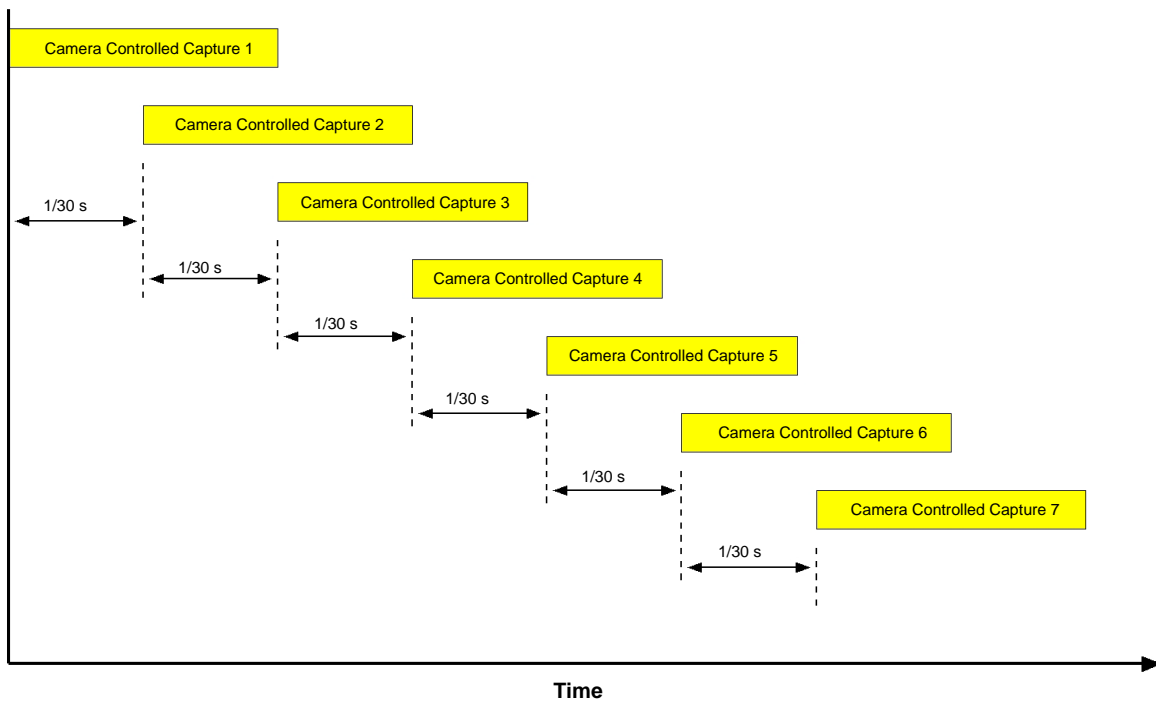

Fig. 15: Normal Image Capture

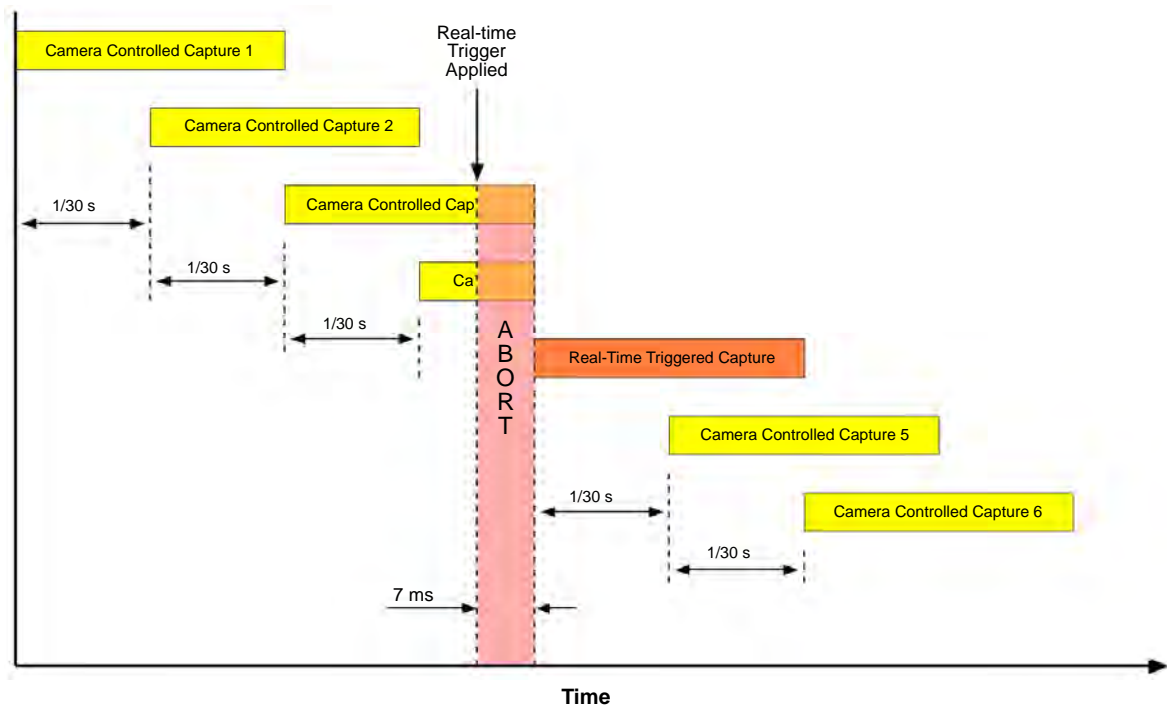

Fig. 16: Real-Time Trigger Image Capture

If you take a close look at Figure 16, you will notice that two of the image captures triggered by the camera's internal process were aborted. These two partially completed images will be dropped and will not be transmitted from the camera.

In this example, there are two images dropped, but the number can actually vary from no images to two images depending on how you are operating the camera. Basically, if you are operating the camera at a frame rate near to the camera's allowed maximum, it will drop two images each time a real-time trigger is applied as illustrated in the example. And if you are operating the camera at a frame rate considerably lower than the maximum allowed, it will drop no images.

Note that if you have several streams enabled, the images will be dropped from every stream.



Because the real-time trigger operates at the sensor level, it impacts all enabled streams. So, for example, if you have three streams enabled, each image capture initiated by a real-time trigger signal will be transmitted in all three streams.



The real-time trigger feature is not available on all camera models. For more information, refer to the specification tables in Section 8 on [page 100](#).

7.2 Enabling and Using Real-Time Triggering

To enable real-time triggering, use the **Digital I/O** tab in the **Input/Output** parameters group (see Section 3.9 on page 58) to properly configure one of the I/O ports. The port should be configured with the **Direction** parameter set as an "Input" and the **Function** parameter set as "Real-time Trigger" as shown to the right.

If the invert function for the port is not enabled (i.e., the **Invert** check box is not checked), an image capture will be triggered whenever the electrical signal applied to the port causes the port to transition from the inactive to the active condition.

If the invert function for the port is enabled (i.e., the **Invert** check box is checked), an image capture will be triggered whenever the electrical signal applied to the port causes the port to transition from the active to the inactive condition.

Note that you can configure more than one port to act as an input with the function set to real-time trigger. In this situation, an image capture will be triggered anytime the proper electrical signal is applied to one of the ports.



If the **Source Enable** check box on the **Digital In** tab in the **Alarm Sources** section of the **Alarm Handling** parameters (see Section 3.6 on page 43) is checked as shown to the right, the camera will declare an alarm condition whenever a real-time trigger signal is applied to the camera.

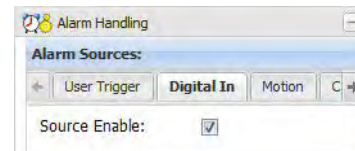

If you have set the parameters on the **Email** tab in the **Alarm Actions** section of the **Alarm Handling** parameters so that the camera will send an email with an included image when an alarm condition is declared (as shown to the right), the image included with the email will be the one that was captured when the real-time trigger signal caused the alarm condition.

Note that if you have set the parameters on the **FTP** tab so that a file and an image will be sent to an FTP server when an alarm condition is declared, the image sent will be the one that was captured when the real-time trigger signal caused the alarm condition.



7.3 Real-Time Triggering Impact on Streams

When you are setting the **Streaming** group parameters on the camera, remember that because the real-time trigger operates at the sensor level, it impacts all enabled streams. So, for example, if you enable three streams, each image capture initiated by a real-time trigger signal will be transmitted in all three streams.

If the **Encoder Type** parameter for a stream is set to "JPEG", "MPEG4", "H.264 Base Profile" or "H.264 High Profile", the images captured as a result of the real-time trigger will be transmitted from the camera as part of the normal image stream as illustrated in Figure 16 on [page 96](#).

If the **Encoder Type** parameter for a stream is set to "JPEG (triggered)" as shown to the right, the stream will only include images captured as a result of using the real-time trigger. The images in the stream will be motion JPEG encoded.

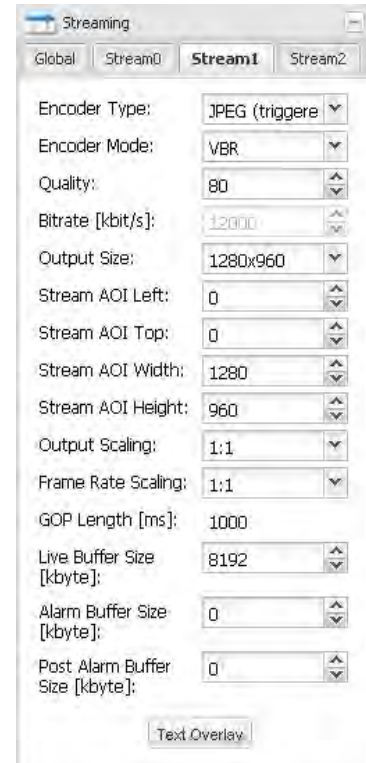

8 Technical Specifications

8.1 BIP2-1300c/-dn and BIP2-1600c/-dn

Specification	BIP2-1300c / BIP2-1300c-dn	BIP2-1600c / BIP2-1600c-dn
Sensor	1/3" progressive scan color CCD Global shutter	1/1.8" progressive scan color CCD Global shutter
Effective Pixels	1280 (H) x 960 (V)	1600 (H) x 1200 (V)
Pixel Size	3.75 µm x 3.75 µm	4.4 µm x 4.4 µm
Frame Rate (at full resolution)	MJPEG MPEG-4 H.264 30 fps 30 fps 30 fps	MJPEG MPEG-4 H.264 12.5 fps 12.5 fps 12.5 fps 25 fps 25 fps 25 fps (BIP2-1600-25c/-dn)
Minimum Illumination Color Mode: Day/Night Mode:	0.34 lux, F1.2/33 ms 0.09 lux, F1.2/33 ms	0.40 lux, F1.4/33 ms 0.11 lux, F1.4/33 ms
Lens Mount	CS-mount, DC Iris drive (lens not included)	
Day/Night	Movable IR-cut filter (BIP2-1300c-dn)	Movable IR-cut filter (BIP2-1600c-dn)
Image Settings	Automatic gain, exposure area, backlight compensation, white balance, electronic shutter, 180° image rotation, mirroring of images, anti-flicker, electronic PTZ via AOI (API), text overlay, privacy masks, motion detection	
Resolutions	From 160 x 120 to 1280 x 960 (free scaling), 4:3, 16:9 Multiple Areas of Interest (AOIs)	From 160 x 120 to 1600 x 1200 (free scaling), 4:3, 16:9 Multiple Areas of Interest (AOIs)
Video Compression	Motion JPEG: Multiple compression levels MPEG-4: SP (Level 3) H.264 (MPEG-4 AVC): Baseline and high profile (levels up to 5.0)	
Video Streaming	Multi-encoding and multi-streaming for MJPEG, MPEG-4, and H.264 VBR and CBR for MJPEG and MPEG-4 VBR, CBR, and CVBR for H.264 Uncompressed YUV images using real-time trigger (max. 4 fps) Multicast and unicast	

Table 4: BIP2-1300c/-dn and BIP2-1600c/-dn Technical Specifications

Specification	BIP2-1300c / BIP2-1300c-dn	BIP2-1600c / BIP2-1600c-dn
Alarm Management	Ring buffer for pre and post alarm images MicroSDHC card slot for local storage (MicroSDHC card is not included with the camera) Events triggered by motion detection or external input Image upload via FTP, Email, or HTTP	
Real-time Trigger	Yes	Yes
Protocols	TCP/IP, HTTP, FTP, UDP, ICMP, ARP, DHCP, NTP, RTP, RTSP, RTCP, SMTP, SNMP, IGMP, ZEROCONF, QoS Layer 3	
Processor / Memory	Multimedia video processor, FPGA, 256 MB RAM, 64 MB flash	
Minimum PC Requirements	Processor: 2.4 GHz (dual core) or 3.5 GHz (single core) RAM: 2 GB Graphics: Nvidia/ATI graphics card, 256 MB video RAM (more recommended), 600 MHz core clock OS: Windows 7 or higher, Linux NIC: 100 Mbps Ethernet CD ROM drive Browser: Internet Explorer 8.0 or higher	
Card Slot	Slot for a microSDHC card (microSDHC card is not included with the camera)	
Power	PoE (Power over Ethernet IEEE 802.3af Class 2) or +12 to + 24 VDC ($\pm 10\%$) Power consumption is 3.5 W max. at 12 VDC	PoE (Power over Ethernet IEEE 802.3af Class 2) or +12 to + 24 VDC ($\pm 10\%$) Power consumption is 3.4 W max. (4.6 W max. for BIP2-1600-25c/-dn) at 12 VDC
Connectors	RJ-45 connector for 10/100 Base-T Ethernet, full or half duplex 8-pin terminal for DC power, digital I/O, and RS-485	
Operating Conditions	BIP2-1300c/-dn and BIP2-1600c/-dn: -10 °C to 50 °C (14 °F to 122 °F) Starting temperature: 0 °C to 50 °C (32 °F to 122 °F) BIP2-1600-25c/-dn: -10 °C to 45 °C (14 °F to 113 °F) Starting temperature: 0 °C to 45 °C (32 °F to 113 °F) < 90% relative humidity (non-condensing)	
Standards	FCC Class B (FCC Class A for BIP2-1600-25c/dn), CE, RoHS, ONVIF The CE Conformity Declaration is available on the Basler website: www.baslerweb.com	
Housing	109.7 mm x 29 mm x 44 mm, full metal casing	
Weight	~ 210 g	

Table 4: BIP2-1300c/-dn and BIP2-1600c/-dn Technical Specifications

8.2 BIP2-1280c/-dn, BIP2-1920c/-dn, and BIP2-2500c/-dn

Specification	BIP2-1280c / BIP2-1280c-dn	BIP2-1920c / BIP2-1920c-dn	BIP2-2500c / BIP2-2500c-dn
Sensor	1/3" progressive scan color CMOS Rolling shutter	1/3" progressive scan color CMOS Rolling shutter	1/2.5" progressive scan color CMOS Rolling shutter
Effective Pixels	1280 (H) x 720 (V)	1920 (H) x 1080 (V)	2560 (H) x 1920 (V)
Pixel Size	3.3 µm x 3.3 µm	2.2 µm x 2.2 µm	2.2 µm x 2.2 µm
Frame Rate (at full resolution)	MJPEG MPEG-4 H.264 30 fps 30 fps 30 fps	MJPEG MPEG-4 H.264 30 fps 24 fps 30 fps	MJPEG MPEG-4 H.264 9 fps 9 fps 9 fps 15 fps 15 fps 15 fps (3 MP)
Minimum Illumination Color Mode: Day/Night Mode:	0.55 lux, F1.2/33 ms 0.13 lux, F1.2/33 ms	0.65 lux, F1.2/33 ms 0.15 lux, F1.2/33 ms	0.65 lux, F1.2/33 ms 0.15 lux, F1.2/33 ms
Lens Mount	CS-mount, DC Iris drive (lens not included)		
Day/Night	Movable IR-cut filter (BIP2-1280c-dn)	Movable IR-cut filter (BIP2-1920c-dn)	Movable IR-cut filter (BIP2-2500c-dn)
Image Settings	Automatic gain, exposure area, backlight compensation, white balance, electronic shutter, 180° image rotation, mirroring of images, anti-flicker, electronic PTZ via AOI (API), text overlay, privacy masks, motion detection		
Resolutions	From 160 x 120 to 1280 x 720 (free scaling), 4:3, 16:9 Multiple Areas of Interest (AOIs)	From 160 x 120 to 1920 x 1080 (free scaling), 4:3, 16:9 Multiple Areas of Interest (AOIs)	From 160 x 120 to 2560 x 1920 (free scaling), 4:3, 16:9 Multiple Areas of Interest (AOIs)
Video Compression	Motion JPEG: MPEG-4: H.264 (MPEG-4 AVC):	Multiple compression levels SP (Level 3) Baseline and high profile (levels up to 5.0)	
Video Streaming	Multi-encoding and multi-streaming for MJPEG, MPEG-4, and H.264 VBR and CBR for MJPEG and MPEG-4 VBR, CBR, and CVBR for H.264 Multicast and unicast	Dual streaming for MJPEG, MPEG-4, or H.264 (MPEG-4 streams must be smaller than 1920 x 1920) VBR and CBR for MJPEG and MPEG-4 VBR, CBR, and CVBR for H.264 Multicast and unicast	

Table 5: BIP2-1280c/-dn, BIP2-1920c/-dn, and BIP2-2500c/-dn Technical Specifications

Specification	BIP2-1280c / BIP2-1280c-dn	BIP2-1920c / BIP2-1920c-dn	BIP2-2500c / BIP2-2500c-dn
Alarm Management	Ring buffer for pre and post alarm images MicroSDHC card slot for local storage (MicroSDHC card is not included with the camera) Events triggered by motion detection or external input Image upload via FTP, Email, or HTTP		
Real-time Trigger	Not available	Not available	Not available
Protocols	TCP/IP, HTTP, FTP, UDP, ICMP, ARP, DHCP, NTP, RTP, RTSP, RTCP, SMTP, SNMP, IGMP, ZEROCONF, QoS Layer 3		
Processor / Memory	Multimedia video processor, FPGA, 256 MB RAM, 64 MB flash		
Minimum PC Requirements	Processor: 2.4 GHz (dual core) or 3.5 GHz (single core) RAM: 2 GB Graphics: Nvidia/ATI graphics card, 256 MB video RAM (more recommended), 600 MHz core clock OS: Windows 7 or higher, Linux NIC: 100 Mbps Ethernet CD ROM drive Browser: Internet Explorer 8.0 or higher		
Card Slot	Slot for a microSDHC card (microSDHC card is not included with the camera)		
Power	PoE (Power over Ethernet IEEE 802.3af Class 2) or +12 to +24 VDC ($\pm 10\%$) Power consumption is 3.2 W max. at 12 VDC		
Connectors	RJ-45 connector for 10/100 Base-T Ethernet, full or half duplex 8-pin terminal for DC power, digital I/O, and RS-485		
Operating Conditions	-10 °C to 50 °C (14 °F to 122 °F) Starting temperature: 0 °C to 50 °C (32 °F to 122 °F) < 90% relative humidity (non-condensing)		
Standards	FCC Class B, CE, RoHS, ONVIF The CE Conformity Declaration is available on the Basler website: www.baslerweb.com		
Housing	109.7 mm x 29 mm x 44 mm, full metal casing		
Weight	~ 210 g		

Table 5: BIP2-1280c/-dn, BIP2-1920c/-dn, and BIP2-2500c/-dn Technical Specifications

8.3 BIP2-1920-30c

Specification	BIP2-1920-30c
Sensor	1/1.3" progressive scan color CMOS Global shutter
Effective Pixels	1920 (H) x 1080 (V)
Pixel Size	5.86 µm x 5.86 µm
Frame Rate (at full resolution)	MJPEG MPEG-4 H.264 30 fps 24 fps 30 fps
Minimum Illumination Color Mode:	0.2 lux, F1.4/33 ms
Lens Mount	C-mount, DC Iris drive (lens not included) CS-mount if adapter with IR-cut filter is removed (0.8 mm spacer required)
Day/Night	No (external IR-cut filter)
Image Settings	Automatic gain, exposure area, backlight compensation, white balance, 180° image rotation, mirroring of images, anti-flicker, electronic PTZ via AOI (API), text overlay, privacy masks, motion detection
Resolutions	From 160 x 120 to 1920 x 1080 (free scaling), 4:3, 16:9 Multiple Areas of Interest (AOIs)
Video Compression	Motion JPEG: Multiple compression levels MPEG-4: SP (Level 3) H.264 (MPEG-4 AVC): Baseline and high profile (levels up to 5.0)
Video Streaming	Multi-encoding and dual-streaming for MJPEG, MPEG-4, and H.264 VBR and CBR for MJPEG and MPEG-4 VBR, CBR, and CVBR for H.264 Multicast and unicast Uncompressed YUV images using real-time trigger (max. 4 fps)
Alarm Management	Ring buffer for pre and post alarm images MicroSDHC card slot for local storage (MicroSDHC card is not included with the camera) Events triggered by motion detection or external input Image upload via FTP, e-mail, or HTTP
Real-time Trigger	Yes
Protocols	TCP/IP, HTTP, FTP, UDP, ICMP, ARP, DHCP, NTP, RTP, RTSP, RTCP, SMTP, SNMP, IGMP, ZEROCONF, QoS Layer 3
Processor / Memory	Multimedia video processor, FPGA, 256 MB RAM, 64 MB flash

Table 6: BIP2-1920-30c Technical Specifications

Specification	BIP2-1920-30c
Minimum PC Requirements	Processor: 2.4 GHz (dual core) or 3.5 GHz (single core) RAM: 2 GB Graphics: Nvidia/ATI graphics card, 256 MB video RAM (more recommended), 600 MHz core clock OS: Windows 7 or higher, Linux NIC: 100 Mbps Ethernet CD ROM drive Browser: Internet Explorer 8.0 or higher
Card Slot	Slot for a microSDHC card (microSDHC card is not included with the camera)
Power	PoE (Power over Ethernet IEEE 802.3af Class 2) or +12 to +24 VDC ($\pm 10\%$) Power consumption is 3.2 W max. at 12 VDC
Connectors	RJ-45 connector for 10/100 Base-T Ethernet, full or half duplex 8-pin terminal for DC power, digital I/O, and RS-485
Operating Conditions	-10 °C to 50 °C (14 °F to 122 °F) Starting temperature: 0 °C to 50 °C (32 °F to 122 °F) < 90% relative humidity (non-condensing)
Standards	FCC Class B, CE, RoHS The CE Conformity Declaration is available on the Basler website: www.baslerweb.com
Housing	109.7 mm x 29 mm x 44 mm, full metal casing
Weight	~ 210 g

Table 6: BIP2-1920-30c Technical Specifications

8.4 Dimensions

The camera dimensions are shown below. Dimensions are in millimeters unless otherwise noted.

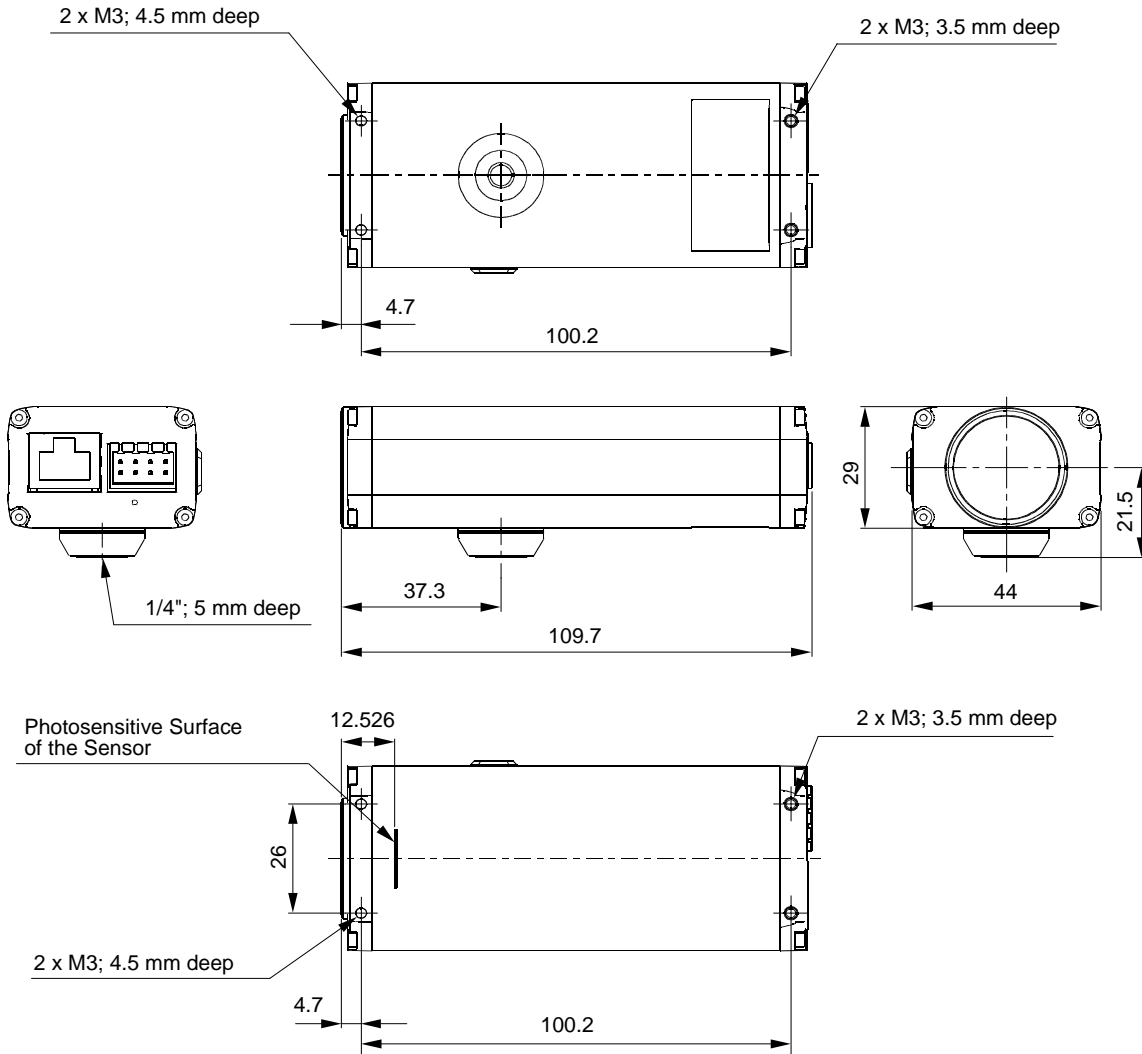

Fig. 17: CS-Mount Camera Dimensions (in mm unless otherwise stated)

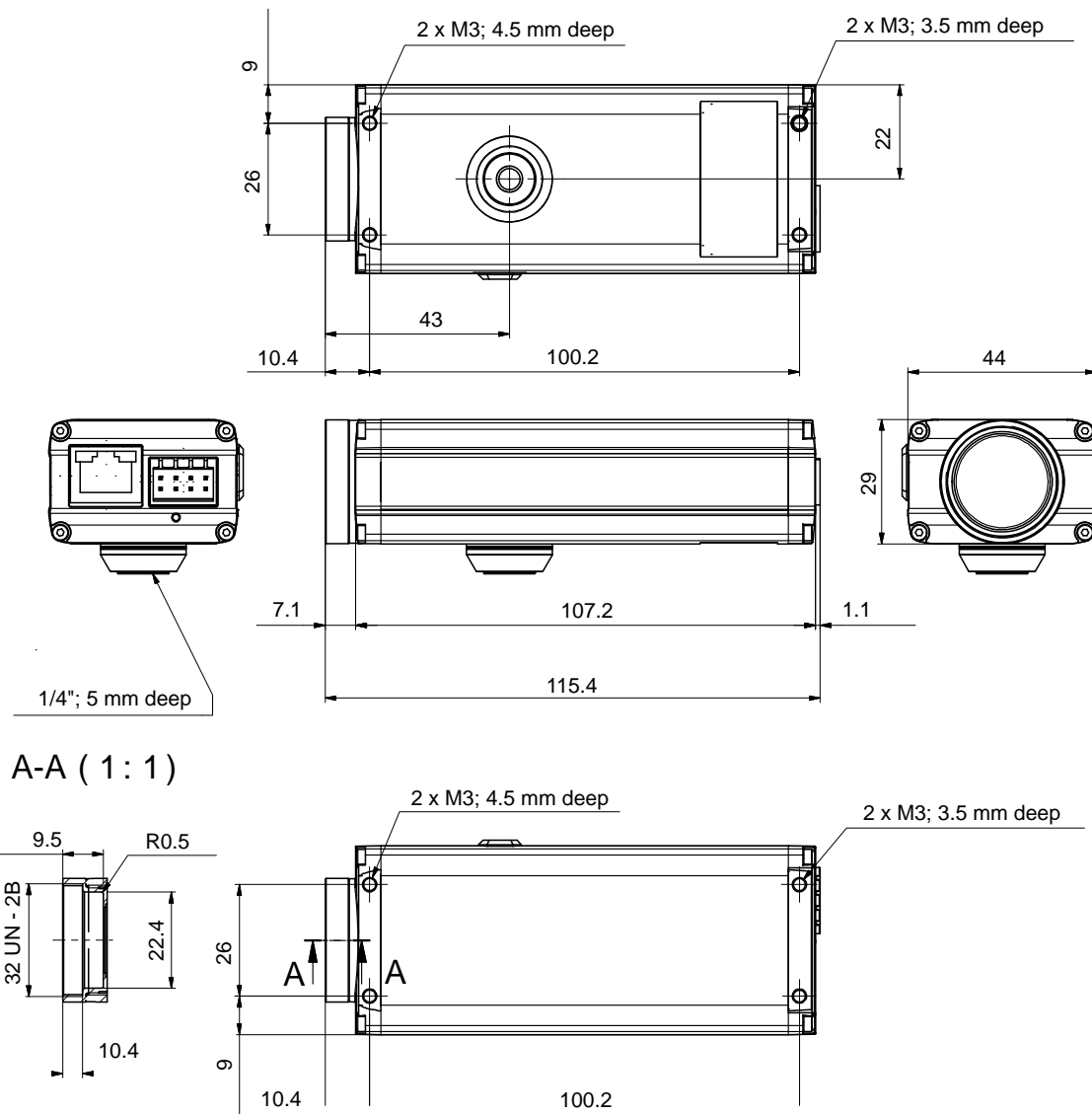

Fig. 18: C-Mount Camera Dimensions (in mm unless otherwise stated)

8.5 Stress Test Results

Basler IP Cameras were submitted to an independent mechanical testing laboratory and subjected to the stress tests listed below. After mechanical testing, the cameras produced normal images during standard operational testing.

Test	Standard	Conditions
Vibration (sinusoidal, each axis)	DIN EN 60068-2-6	10-58 Hz / 1.5 mm_58-500 Hz / 20 g_1 octave/minute 10 repetitions
Shock (each axis)	DIN EN 60068-2-27	20 g / 11 ms / 10 shocks positive 20 g / 11 ms / 10 shocks negative
Bump (each axis)	DIN EN 60068-2-29	20 g / 11 ms / 100 shocks positive 20 g / 11 ms / 100 shocks negative
Vibration (broad-band random, digital control, each axis)	DIN EN 60068-2-64	15-500 Hz / 0.05 PSD (ESS standard profile) / 00:30 h

Table 7: Mechanical Stress Tests

Appendix A Software License Information

MPEG-4

THIS PRODUCT IS LICENSED UNDER THE MPEG-4 VISUAL PATENT PORTFOLIO LICENSE FOR THE PERSONAL AND NON-COMMERCIAL USE OF A CONSUMER FOR (i) ENCODING VIDEO IN COMPLIANCE WITH THE MPEG-4 VISUAL STANDARD ("MPEG-4 VIDEO") AND/OR (ii) DECODING MPEG-4 VIDEO THAT WAS ENCODED BY A CONSUMER ENGAGED IN A PERSONAL AND NONCOMMERCIAL ACTIVITY AND/OR WAS OBTAINED FROM A VIDEO PROVIDER LICENSED BY MPEG LA TO PROVIDE MPEG-4 VIDEO. NO LICENSE IS GRANTED OR SHALL BE IMPLIED FOR ANY OTHER USE. ADDITIONAL INFORMATION INCLUDING THAT RELATING TO PROMOTIONAL, INTERNAL AND COMMERCIAL USES AND LICENSING MAY BE OBTAINED FROM MPEG LA, LLC. SEE [HTTP://WWW.MPEGLA.COM](http://www.mpegla.com).

AVC (H.264)

THIS PRODUCT IS LICENSED UNDER THE AVC PATENT PORTFOLIO LICENSE FOR THE PERSONAL AND NON-COMMERCIAL USE OF A CONSUMER TO (i) ENCODE VIDEO IN COMPLIANCE WITH THE AVC STANDARD ("AVC VIDEO") AND/OR (ii) DECODE AVC VIDEO THAT WAS ENCODED BY A CONSUMER ENGAGED IN A PERSONAL AND NON-COMMERCIAL ACTIVITY AND/OR WAS OBTAINED FROM A VIDEO PROVIDER LICENSED TO PROVIDE AVC VIDEO. NO LICENSE IS GRANTED OR SHALL BE IMPLIED FOR ANY OTHER USE. ADDITIONAL INFORMATION MAY BE OBTAINED FROM MPEG LA, L.L.C. SEE [HTTP://WWW.MPEGLA.COM](http://www.mpegla.com).

Accordingly, please be advised that service providers, content providers, and broadcasters are required to obtain separate use licenses from MPEG LA prior to any use of AVC/MPEG-4/H.264 encoders and/or decoders.

Other Software

The camera contains software originating from a variety of third parties. To view the software license information:

1. Start the IP Camera Web Client as described in Section 2 on [page 6](#).
2. Click the **About** tab as shown below.
3. Click the **Copyright** link as shown below. A page containing license information will appear.

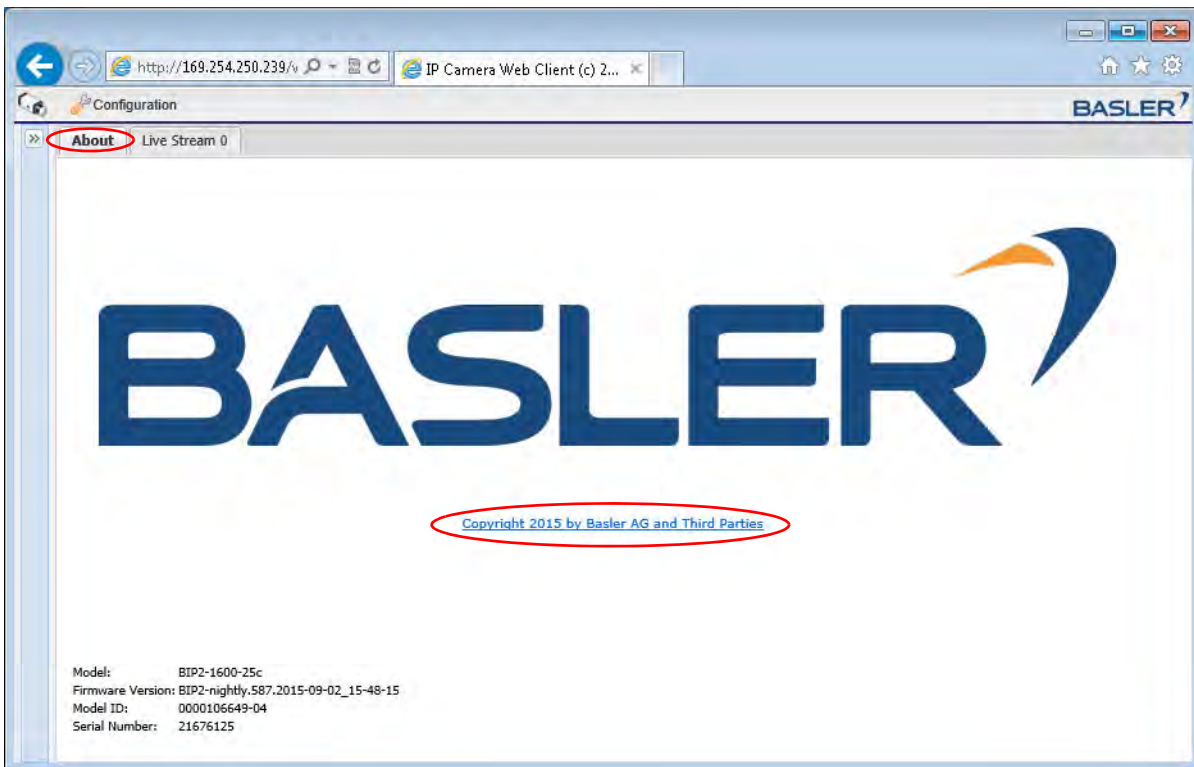

Revision History

Doc. ID Number	Date	Changes
AW00097201000	6 Dec 2010	Initial release of this document.
AW00097202000	23 Feb 2011	Added information for the new image mirror (see) page 22and real-time trigger (see page 95) features.
AW00097203000	7 Jun 2011	Added AOI size restriction for the MPEG 4 encoder type on page 31. Added the new CVBR encoder mode and the new Maximum Bitrate setting on page 32. Added the new Overlay Size and Overlay Style parameters on page 37. Updated the specification tables in Section 8.
AW00097204000	27 Jul 2011	Updated the specification tables in Section 8.
AW00097205000	27 Mar 2012	Added the description of the new Manual selection and Fit into Window buttons appearing below the live stream (see page 12). Added the description of the Cyclic tab in the Alarm Sources section (see page 44). Added the description of the Heartbeat Missing tab in the Alarm Sources section (see page 44). Updated the HTTP URL parameter description and added the new HTTP URL Alarm End parameter description on the HTTP tab (see page 47). Added the description of the new SNMP tab in the Network group (see page 57). Added the new Forwarding Mode parameter description for serial port forwarding (see page 65). Added the description of enabling an anonymous access to streams (see page 66). Updated entries for clock synchronization with an NTP server.
AW00097206000	31 Jul 2012	Added the description of the new Live Recording tab in the Alarm Actions section (see page 49). Added the new Live Recording group description (see Section 3.7 on page 51). Added the descriptions of the new parameters Zero Configuration, Host Name Source, Name Server Source, and Search Domain to the Settings tab (Network group) (see page 54). Updated the Name Server parameter description (see page 54). Added the description of the ONVIF tab with the new Enable parameter (see page 57). Added the description of the new NTP Server Source parameter (see page 74). Updated the NTP Server parameter description (see page 74). Updated the specification tables in Section 8.

Doc. ID Number	Date	Changes
AW00097207000	24 Apr 2013	<p>Updated the Support contact information in the Contacting Basler Support Worldwide section (see page 2).</p> <p>Updated the Frame Rate Mode parameter description (see page 22).</p> <p>Added the Capped VBR value to the Encoder Mode parameter (see page 32).</p> <p>Updated the Quality (see page 32) and Maximum Bitrate parameters (see page 33) to reflect their use with the Capped VBR mode.</p> <p>Added missing standard sizes to the Output Size parameter description (see page 33).</p> <p>Added information about the second text overlay to the description of the Text Overlay dialog box (see page 36).</p> <p>Added the descriptions of the new Overlay Text parameter values (see page 36).</p> <p>Updated the descriptions of the Overlay Position parameter values (see page 37).</p> <p>Updated the descriptions of the Overlay Size parameter values (see page 37).</p> <p>Updated the description of the Overlay Style parameter (see page 37).</p> <p>Added the descriptions of the new buttons (+Image, Clear, Revert All Changes, View Current Overlay Image, Upload New Overlay Image, Close) in the Text Overlay dialog box (see page 38).</p> <p>Added section about using images in stream overlays (see page 39).</p> <p>Added descriptions of the new Multicast Stream and Multicast Metainfo parameters on the RTSP tab (see page 55).</p> <p>Added the new Available Streams via ONVIF parameter description (see page 57).</p> <p>Added the value External Trigger in for the Function parameter (see page 59).</p> <p>Added descriptions of the new External Clock Synchronization and NTP Synchronization Period parameters in the System parameters group (see page page 73).</p> <p>Removed the NTP parameter in the System parameters group.</p> <p>Updated Standards information in Table 4, Table 5, and Table 6 (see Section 8).</p> <p>Added SD card information throughout the manual.</p>

Doc. ID Number	Date	Changes
AW00097208000	3 Apr 2014	<p>Updated mask editor descriptions (see page 24).</p> <p>Added the YUV (RT triggered) value to the Encoder Type parameter (see page 32).</p> <p>Added the Strobe Mode parameter in the Digital I/O parameters group (see page 59).</p> <p>Added information about global and rolling shutters and the implications of filming moving objects with rolling shutter cameras (see page 60).</p> <p>Added information about maximum length of unshielded cables (see page 83).</p> <p>Updated the description about an I/O port set as an input (see page 84) and the corresponding I/O schematic (see page 86).</p> <p>Added shutter type information in Table 4, Table 5, and Table 6 (see Section 8).</p>
AW00097209000	14 April 2014	<p>Updated the frame rate for H.264 in Table 4 on page 100.</p> <p>Updated the video streaming information in Table 4 on page 100 and Table 5 on page 102.</p>

Doc. ID Number	Date	Changes
AW00097210000	28 Oct 2015	<p>Minor updates throughout the manual.</p> <p>Changes to reflect renaming of Surveillance Web Client to IP Camera Web Client.</p> <p>Updated the Support contact information in the Contacting Basler Support Worldwide section (see page 2).</p> <p>Added overview drawing of BIP2-1920-30c in Figure 1 on page 4.</p> <p>Added information about supported file systems (see page 5).</p> <p>Added the description of the new Shadows parameter (see page 15).</p> <p>Added the description of the new RTT tab in the Image Controls group (see page 18).</p> <p>Added the description of the new Exclude RTT Images parameter (see page 35).</p> <p>Added a note that on BIP2-1920-30c cameras at least one stream always has to be set to 1:1 output scaling (see page 34).</p> <p>Updated information about using images in stream overlays (see "Using Images in Stream Overlays" on page 40).</p> <p>Updated the description of the Erase SD Card parameter (see page 53).</p> <p>Updated the description of the ONVIF tab (see page 57).</p> <p>Added the RTT Exposure Active value to the Strobe Mode parameter (see page 59).</p> <p>Added information about capturing color images in night mode (see page 90).</p> <p>Added information about using the day/night parameters on BIP2-1920-30c camera models (see page 90).</p> <p>Added a notice box about the risk of damage caused by electrostatic discharge (ESD) in chapter 5 on page 82.</p> <p>Added specifications of new camera model, BIP2-1920-30c, in Table 8.4 on page 106.</p> <p>Added dimension drawings of BIP2-1920-30c in Section 8.5 on page 108.</p>
AW00097211000	12 Nov 2015	Removed section.
AW00097212000	13 Jan 2016	Added the description of the new RTT tab in the Image Controls group (see page 18).
AW00097213000	14 Jun 2016	Minor changes.
AW00097214000	11 Sep 2018	Removed the following discontinued cameras from the documentation: BIP2-640c, BIP2-640c-dn.
AW00097215000	2 Nov 2018	<p>Qualified the use of 30 fps in Section 3.4.1 on page 21.</p> <p>Corrected max. frame rate at full resolution with MPEG-4 to 24 fps for the BIP2-1920c and BIP2-1920c-dn in Section 8.2 on page 102 and for the BIP2-1920-30c in Section 8.3 on page 104.</p>
AW00097216000	27 Jan 2020	Removed the BIP2-1000c/-dn throughout the manual.

Index

A

adding a user.....	69
alarm actions.....	46
alarm buffer size parameter	35
alarm buffer state parameter	45
alarm buffers	45
alarm DSCP parameter	56
alarm handling parameters.....	43
alarm off delay parameter	42
alarm on delay parameter	42
alarm sources.....	43
anti-flicker parameter.....	14
area of interest	
sensor	21
stream	30
arm buffer button.....	45
authentication enabled parameter.....	66
authentication, serial port	65
authentication	66
auto brightness mask	26

B

backlight compensation parameter	14
baud rate parameter.....	65
baud rate, serial port	65
bitrate parameter	33
black level parameter	19
blue gain parameter	
appearance tab	16
RTT tab	19
browser requirements.....	6

C

camera power via the terminal connector	84
capped variable bitrate mode	32
card slot.....	5
c-mount	5
configuration management.....	75
configuring the camera.....	7
constant bitrate mode.....	32
constant-variable bitrate mode	32
control mode parameter	18
cs-mount.....	5
cyclic tab.....	44

D

date time format parameter	72
date/time tab	72
day/night functionality	88
DC iris control	5
DC out.....	84
defaults, resetting to	74
deleting a user	69
DHCP parameter	54
digital I/O port parameters	58
digital I/O tab.....	58
digital in tab.....	43
digital output hold time parameter	46
digital output tab	46
direction parameter.....	58
disable buffer button	45

E

email parameter.....	46
email password parameter	46
email port parameter.....	46
email sender parameter.....	47
email server parameter.....	46
email tab	46
email username parameter.....	46
encoder mode parameter	32
encoder type parameter.....	31
erasing the SD card	53
exposure active.....	64
exposure active signal	64
exposure mode parameter.....	13
exposure offset parameter	14
exposure time limit parameter	14
exposure time parameter	
exposure tab.....	14
RTT tab.....	18, 19
external clock synchronization parameter	73
external trigger.....	59

F

factory default button	5, 81
factory defaults, resetting to.....	74, 81
firmware updates	1, 78
firmware version parameter	72
fit to window button	12

flash window	62	I/O port parameters	58
flash window signal	62	image controls parameters	13
forwarding mode	65	image mirror parameter	22
forwarding parameter	65	image rotation parameter	22
forwarding, serial port	65	include image parameter	50
frame rate		include stream parameter	50
image capture	8	info tab	72
stream	8	invert check box	59
frame rate mode parameter	22	IP address parameter	54
frame rate scaling parameter	35	IP Camera Web Client	6, 10
FTP password parameter	49, 53	IR filter current level parameter	17, 90
FTP port parameter	48, 53	IR filter mode parameter	17
FTP remote dir parameter	48, 53	IR filter state parameter	17
FTP server parameter	48, 53	IR filter switch level parameter	17, 89
FTP tab	48	IR filter wait time parameter	18, 90
FTP tab (live recording group)	53	IR-cut filter	88
FTP user name parameter	48, 53	external	90
function parameter	58	iris mode parameter	14
G		J	
gain limit parameter	15	JPEG	31
gain parameter		L	
exposure tab	15	lens adapter	5
RTT tab	18	line configuration parameter	65
gamma parameter		line configuration, serial port	65
appearance tab	15	live buffer size parameter	35
RTT tab	19	live images, viewing	6
global shutter	60	live memory allocation parameter	52
global tab	21	live recording behavior parameter	49
GOP length parameter	35	live recording mode parameter	51
granularity parameter	41	live recording parameters	51
ground	84	live recording tab (alarm actions)	49
H		M	
H.264	31	MAC address parameter	72
heartbeat missing tab	44	management tab	74
history image frames parameter	41	managing users	68
host name parameter	54	manual selection button	12
host name source parameter	54	manufacturer name parameter	72
HTTP DSCP parameter	56	mask editor tools	29
HTTP Port parameter	55	mask editors	24
HTTP tab	47	masks	
HTTP URL Alarm End parameter	48	auto brightness	26
HTTP URL request parameter	47	motion	28
I		privacy	27
I/O pins	84	white balance	25

maximum bitrate parameter	33
mirror	22
MJPEG	31
model name parameter	72
motion detection mode parameter.....	41
motion detection parameters.....	41
motion JPEG	31
motion limit parameter.....	42
motion mask	28
motion tab.....	44
motion threshold parameter	42
MPEG4.....	31
multicast IP parameter	55
multicast metainfo parameter	55
multicast on-demand parameter.....	55
multicast parameter.....	55
multicast port parameter.....	55
multicast stream parameter.....	55
multicast TTL parameter	55
N	
name server parameter	54
name server source parameter	54
network I/O tab	56
network parameters.....	54
network prefix parameter.....	54
network traffic in parameter.....	56
network traffic out parameter.....	56
NTP server parameter.....	74
NTP server source parameter	74
NTP synchronization period parameter....	73
O	
ONVIF tab	57
output scaling parameter	34
output size parameter.....	33
overlay position parameter	37
overlay size parameter	37
overlay style parameter	37
overlay text	
streamed images.....	36
overlay text parameter.....	36
overwrite live recordings parameter	52
P	
parameter settings, saving & restoring....	75
passwords, changing.....	70
plugin help button	11
PoE	5
port parameter	65
port, serial	65
ports, digital I/O.....	58
post alarm buffer size parameter	35
post-alarm time period parameter.....	49
pre-alarm time period parameter	49
precautions	2
privacy mask.....	27
Q	
QoS tab.....	56
quality parameter	32
R	
real-time trigger.....	43, 58, 95
rearm alarm buffer parameter.....	50
red gain parameter	
appearance tab.....	16
RTT tab.....	19
refresh rate box.....	11
reset to factory defaults	74, 81
restarting the camera.....	74
restoring parameter settings	75
rolling shutter	60, 61
rotation	22
RS-485 A+ connection.....	85
RS-485 B- connection.....	85
RTSP DSCP parameter	56
RTSP enabled parameter	55
RTSP port parameter.....	55
RTSP tab	55
S	
saturation parameter	
appearance tab.....	15
RTT tab.....	19
saving parameter settings.....	75
SD card	
supported file systems.....	5
SD card overwrite parameter.....	50
SD card slot	5
SD card tab (alarm actions)	50
SD card tab (live recording group).....	52
search domain parameter.....	55
sensitivity parameter.....	41

