

# LL330 Series

## Sealed High Intensity Line Lights Product Datasheet



### Scalable and End-to-End Stackable Housing

Built with extrusion-based aluminum construction, the LL330 scales linearly in 150mm increments up to 1m. For lengths exceeding 1m, its end-to-end stackable design allows for longer configurations.

### Dust and Debris Protected

Engineered to be completely sealed from dust and debris for reliable performance in harsh environments

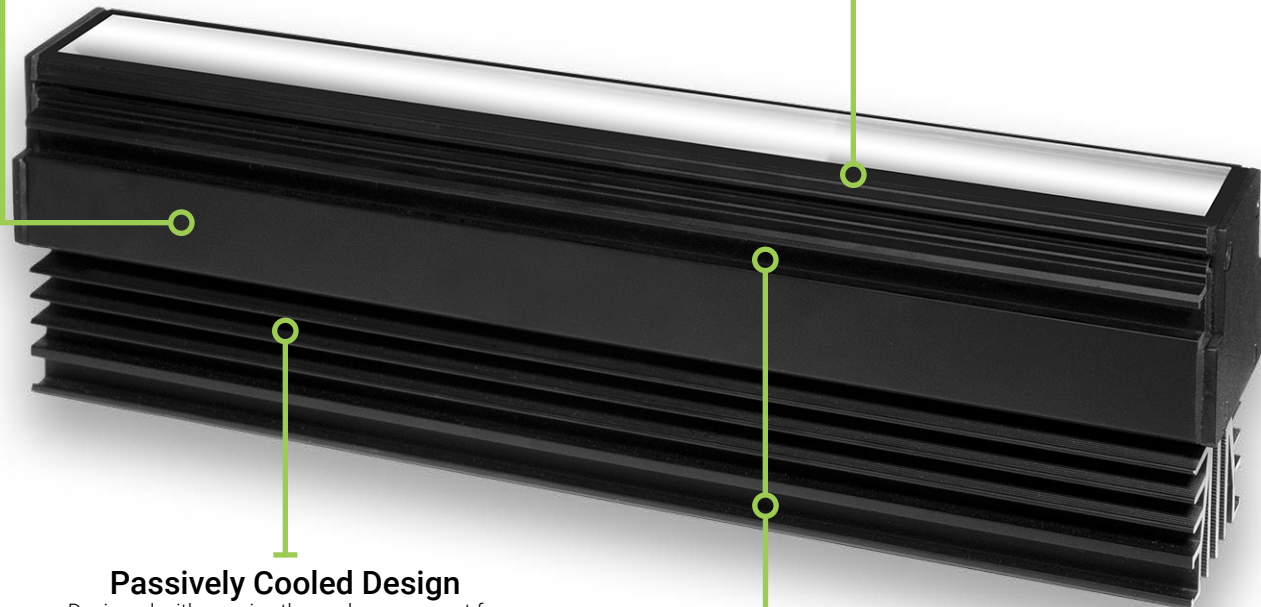

### Passively Cooled Design

Designed with passive thermal management for reliable, minimal maintenance operation

### M6 Mounting Channels

Equipped with two M6 mounting channels on each side, allowing for highly adjustable and stable positioning

## LL330 Series Description

The LL330 Series provides a sealed high intensity line light solution for demanding industrial environments. Engineered to withstand harsh conditions, these line lights are completely protected from dust and debris, ensuring reliable performance where other lights fail. Their passive thermal management eliminates the need for active cooling fans, contributing to low-maintenance, long-term operation.

The LL330 is available with an embedded control option, designed for continuous operation and housed within the configured light head. With options for converging or collimating optics, this series is suited for a variety of application needs. The LL330 is ideal for sheetrock, lumber, ceramics, stone, and other industries utilizing line scan imaging where airborne particulate, dust, and debris are concerns.



**High Intensity**



**Dust Proof**



**Passively Cooled**



**Scalable Design**



**1-3 Week BTO Lead Times**

**General Information**

**General Specifications**

Category	Specification	Detail			
<b>Optical</b>	Available Wavelengths	White, 365 nm, 375 nm, 385 nm, 395 nm, 405 nm, 455 nm, 470 nm, 530 nm, 625 nm, 660 nm, 850 nm, 940 nm			
	Available Lensing	D (Converging; Optimal WD at 25 mm) and G (Collimating)			
	Available Light Conditioning	None			
<b>Electrical</b>	Power Consumption Info	<a href="#">See Power Requirements on Page 7</a>			
	Cable/Connector Info	C1 Option: 80" -0/+6" Long Cable (2 m -0/+150 mm), 105 °C Rated, Foil Shield w/ Drain EC Option: Male Bulkhead Connector, M12, 4-pos, T-Coded			
<b>Mechanical</b>	Sizing Info	Standard	Length	6.29" (159.8 mm) to 41.72" (1059.8 mm)	<a href="#">See Page 6 for More Details</a>
		Width	2.70" (68.6 mm)		
		Height	3.66"(92.9 mm)		
	Weight Info (Standard)	~3.18 lbs (1442 g) per 300 mm unit			
	Mounting Info	M6 Mounting Nut Channel			
	Material Info	Anodized Aluminum Housing, Acrylic Window, Nickel Plated Brass Bulkhead Connector and Strain Relief, Steel Black Oxide and Zinc Plated Steel Fasteners, Neoprene Gasket, Rubberized Epoxy			
<b>Thermal</b>	Operating Case Temperatures	25 °C to 70 °C			
	Operating Ambient Temperatures	0 °C to 35 °C			
<b>Certification</b>	Compliance	CE, RoHS, IEC 62471			
	IP Rating	IP67			
	Lumen Maintenance - White Only	L70 (50,000 Hours)			

**General Information - Continued**

**Part Number Key**

Model	Lens Focus	Emitting Length (mm)	-	Peak Wavelength <sup>3</sup>	Connector/Control
LL330	D (Converging) <sup>1</sup>	0150	-	365	EC
	G (Collimating)	0300		375	C1
		0450		385	
		0600		395	
		0750		405	
		0900		455	
		1050 <sup>2</sup>		470	
				530	
				625	
				660	
				850	
				940	
				WHI	
more information on page		7		4	8

**Example Part Numbers:**  
LL330G0300-WHIEC  
LL330D0600-625C1

<sup>1</sup>The D lens configuration has an optimal working distance of 25 mm  
<sup>2</sup>This product is end-to-end stackable for applications requiring 1 m or longer line lengths  
<sup>3</sup>More wavelengths available upon inquiry

**In Stock**

Unavailable

**Lead Times**

Build-to-Order products ship within one to two weeks.

**Online Configurator**

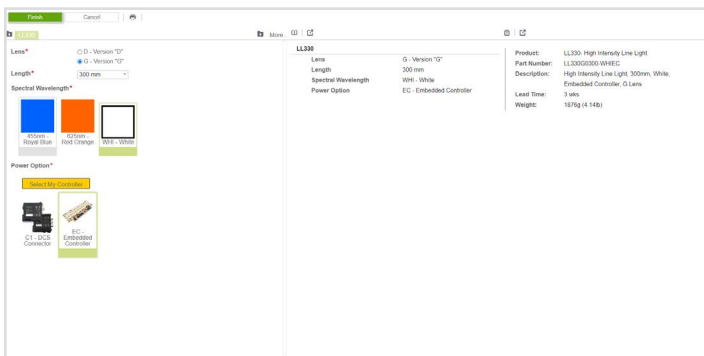

Need a build-to-order custom lighting solution in 2 weeks or less? Advanced Illumination's online configurator helps you tailor our LL330 Series to your specific needs. For a guided configuration, visit our [online configurator](#).

**Optical Information**

**Intensity Characteristics**

**Intensity Distribution Image at 50 mm Working Distance**

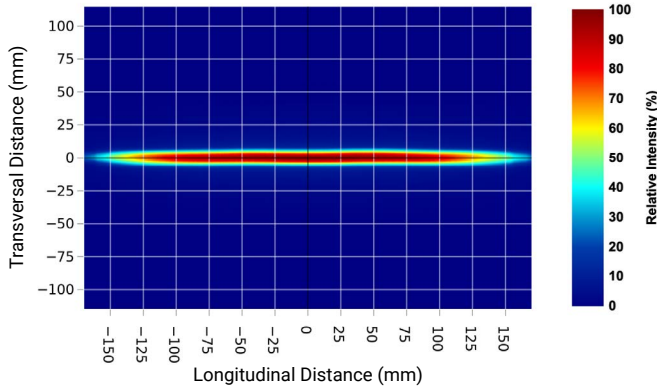

Intensity distribution sample image was taken with a 12-inch white LL330 unit with a G lens.

**Illuminance vs Working Distance**

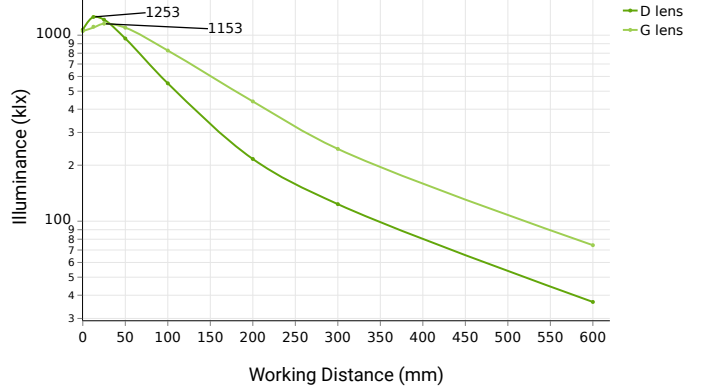

Illuminance data was collected using a 12-inch white LL330 unit.

**Line Width**

**Uniformity**

**Line Width vs Working Distance**

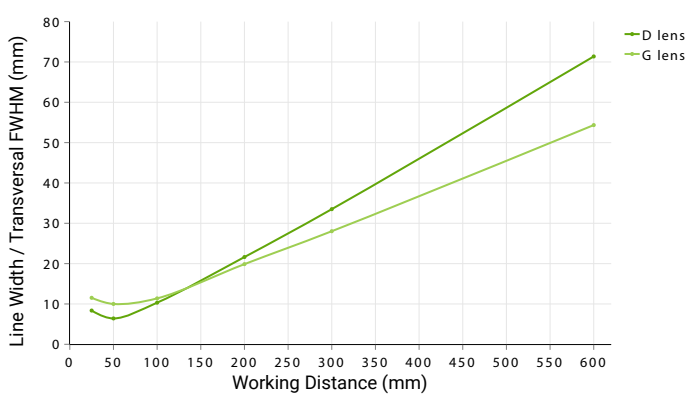

Line width data was collected using a 12-inch white LL330 unit.

**Longitudinal Intensity Distribution Profile at 50 mm Working Distance**

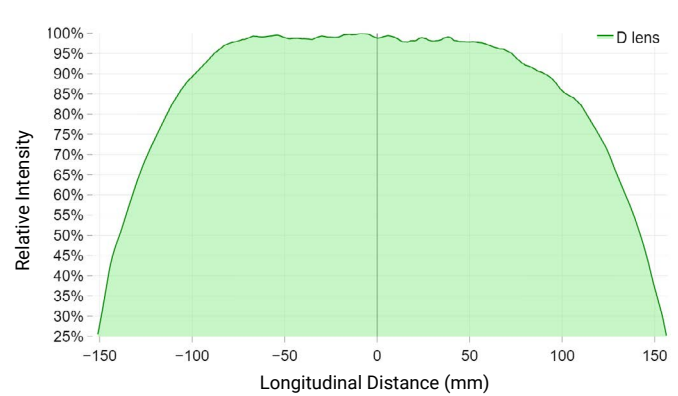

Longitudinal intensity distribution data was collected using a 12-inch white LL330 unit with a D lens.

**White Spectral Profile**

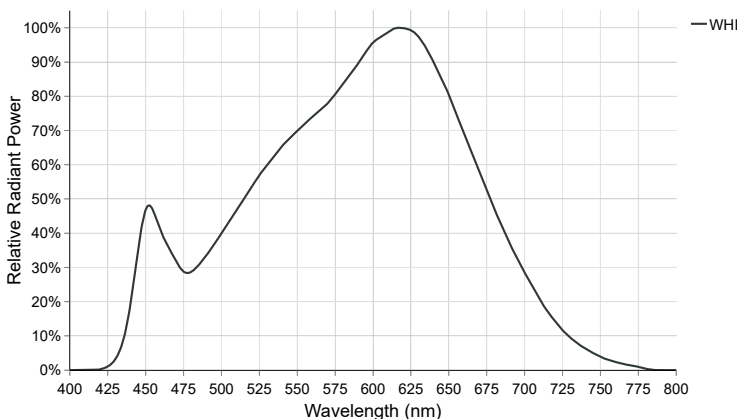

White LED illumination is the most commonly used machine vision lighting configuration. It is often the default choice when specific features of interest do not require color-based highlighting. However, [white LEDs can vary in color temperature between different lighting families, which can impact machine vision systems](#), specifically when matching white light sources.

The LL330 Series white LEDs have a relatively neutral color correlated temperature (CCT) of **5700 K**.

For a more detailed look at the white spectral data, download the [csv file of the raw spectral values](#) and refer to our [Product Spectra Distribution Charts PDF](#).

Disclaimer: The measurements provided above are for approximations only and may vary depending on the method of measurement and the specific configuration being measured.

**Optical Information - Continued**

**Visible Spectral Profiles**

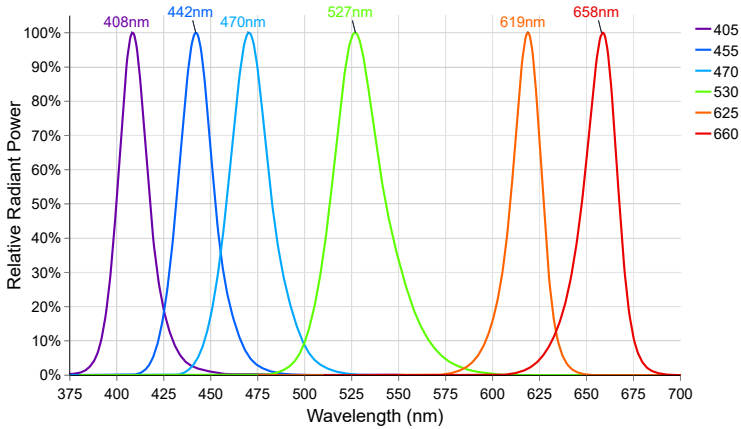

Visible color illumination consists of using wavelengths between 400-700 nm to either create or eliminate contrast on an inspection subject based on differences in a materials color hue. When referring to a color wheel, simply remember the following: like colors reflect and brighten surfaces; conversely, opposing colors absorb and darken surfaces.

The LL330 Series is available in **405 nm, 455 nm, 470 nm, 530 nm, 625 nm, and 660 nm** configurations.

For a more detailed look at the visible color spectral data, download the [csv file of the raw spectral values](#) and refer to our [Product Spectra Distribution Charts PDF](#).

**Non-Visible Spectral Profiles**

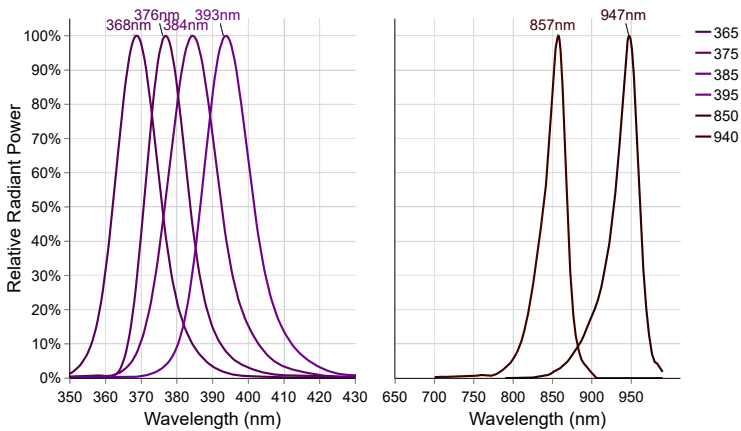

Near-infrared (NIR) imaging is a machine vision technique using longer wavelengths of 700-1000 nm to penetrate specific materials that are otherwise opaque under the visible spectrum. Ultraviolet A (UVA) imaging uses shorter wavelengths of 315-400 nm, often used for fluorescence applications.

The LL330 Series is available in **365 nm, 375 nm, 385 nm, 395 nm, 850 nm, and 940 nm** configurations.

For a more detailed look at the NIR and UV spectral data, download the [csv file of the raw spectral values](#) and refer to our [Product Spectra Distribution Charts PDF](#).

**Optical Information - Continued**

**Photobiological Risk Factors**

Group	Description	Affected Wavelengths (nm)
Exempt	No Photobiological Hazard	850, 940
Group 1	No Photobiological hazard under normal behavioral limitations	455, 470, 530, 625, 660
Group 2	Does not pose a hazard due to aversion response to bright light or thermal discomfort	White

Advanced Illumination's lighting products have been tested and classified to IEC standards by accredited testing services. For more information on photobiological risk factors, please view the following PDF: <https://www.advancedillumination.com/wp-content/uploads/2019/04/IEC-040119.pdf>

**Cleaning Guidelines**



To clean our light's optics, it is best to only clean when necessary. Dusting is always the first step in cleaning your optics. Wiping a dusty optic is like cleaning it with sandpaper. So always dust with a canned air duster or compressed and filtered air before wiping any optic. If the dusted optic has no visible stains after you dust it, then remember: "If it's not dirty, don't clean it." Avoid wiping optics when possible.

If dusting did not clean the lens or the lens has stains, use only de-ionized water and mild dish soap with a low lint cloth designed for optics to avoid damage to the optic by any harsh chemicals.

Polarizers, beam splitters and collimated films should never be wiped with any type of cloth or solvent, only use the air dusting method to clean these types of optics.

The aluminum housing can be wiped down when dusting is not a sufficient means to thoroughly clean.

**Mechanical Information**

**Installation Drawings**

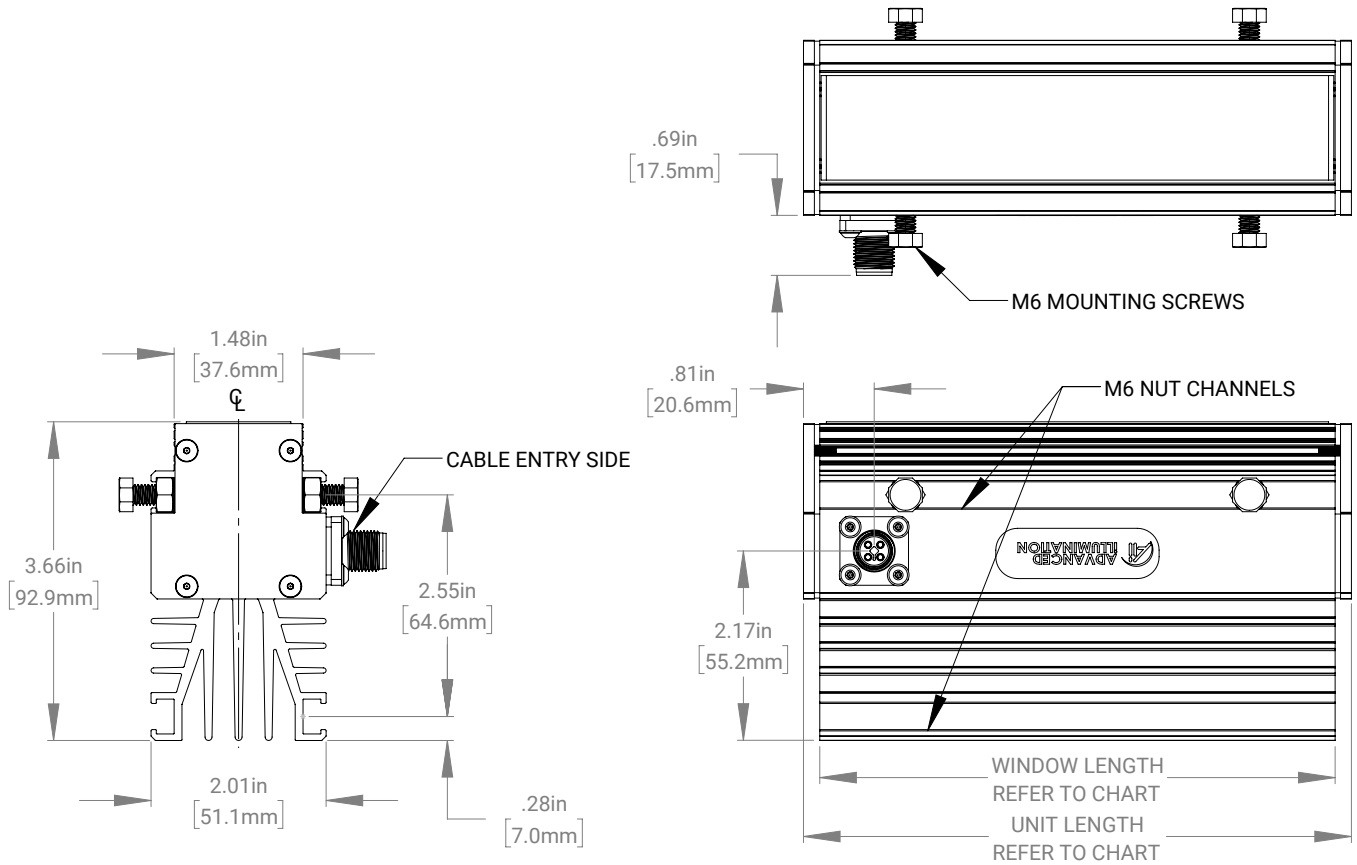

For full installation drawings and complete CAD models of this configuration, please visit the [downloads section of the product webpage](#).

**Sizing Information**

Part Number	Length (Inches)		Length (Millimeters)	
	Unit	Window	Unit	Window
LL330X-0150	6.29	5.92	159.8	150.3
LL330X-0300	12.20	11.82	309.8	300.3
LL330X-0450	18.10	17.73	459.8	450.3
LL330X-0600	24.01	23.63	609.8	600.3
LL330X-0750	29.91	29.54	759.8	750.3
LL330X-0900	35.82	35.44	909.8	900.3
LL330X-1050	41.72	41.35	1059.8	1050.3

Note: The LL330 Line Light Series is end-to-end stackable for line lengths longer than 1 m.

**Electrical Information**







**Power Requirements**

**Current Required for Power Supply Sizing**

Wavelengths (nm)	Configured w/ Embedded Controller (EC)	Configured w/ External Controller (C1)
White, 455, 470, 530, 625, 850, 940	1.5A per 150mm Unit	1.5A per 150mm Unit

Note: All Advanced Illumination lights and controllers are nominally powered by 24V DC unless otherwise noted. Strobe overdriving with controller based models may require more current and voltage overhead. The values above do not include background current draw from the controller (~100 mA total).

**Control Options**

Controller Image	Controller Details	Connector Image
	<p><b>DCS Single Output Controller - Compatible with C1 Configurations</b> PN: DCS-100E</p> <p>The DCS-100E is a compact, din-rail mounted general-purpose external controller with one C1 output connector, wired with three channels. Capable of providing single channel control or multi-channel control for RGB compatible lights.</p> <p><b>Output Power:</b> 90 W Max Continuous, 540 W Max Pulsed (Overdrive Strobe)  <b>Output Current:</b> 4.5A Max Continuous, 15 A Max Pulsed  <b>I/Os:</b> 3 External Trigger Inputs  <b>Interface:</b> 10/100 Ethernet with Software and browser-based GUIs. SDKs are also available.</p> <p>For more information about our DCS-100E, please <a href="#">visit the controller product page</a>.</p>	
	<p><b>DCS Triple Output Controller - Compatible with C1 Configurations</b> PN: DCS-103E</p> <p>The DCS-103E is a din-rail mounted general-purpose multi-light controller with three C1 output connectors. Capable of driving three lights in sync or asynchronously.</p> <p><b>Output Power:</b> 30 W Max Continuous / Output, 180 W Max Pulsed / Output  <b>Output Current:</b> 1.5A Max Continuous / Output, 5 A Max Pulsed / Output  <b>I/Os:</b> 3 External Trigger Inputs  <b>Interface:</b> 10/100 Ethernet with Software and browser-based GUIs. SDKs are also available.</p> <p>For more information about our DCS-103E, please <a href="#">visit the controller product page</a>.</p>	
	<p><b>Embedded Controller - Continuous Only - EC Configurations</b> PN: N/A</p> <p>The EC is an embedded controller engineered for continuous-only operation with the configured light head.</p> <p><b>I/O:</b> 0 V - 10 V (10% to 100% intensity) Analog Dimming Input  <b>Interface:</b> Bulkhead Connector (M12 4-pin T-Coded Male)</p>	



**Electrical Information - Continued**

**Embedded Control Option Wiring Information**



**M12 Bulkhead Connector Pinout Functions and Optional Cable Flying Lead Functions**

Pin (M12)	Wire Color (Optional Cable)	EC Functions	M12 Pinout
1	BROWN	24V DC	 <p>5-Position Male Bulkhead Connector</p>
2	WHITE	0-10V Analog Control	
3	BLUE	DC GND	
PE	BLACK	N/A	

The functions above are only applicable when ordering an EC power configuration.

**Accessories**

Advanced Illumination offers a variety of accessories designed to pair with our lighting and control products. Below you will find a table of accessories which are compatible with many configurations of the LL330 series.

Category	Accessory Image	Accessory Detail
Power Supply		<p><b>24 Volt DC Power Supply</b> PN: PS24-TL</p> <p>This convenient power source is a universal AC input switching power supply with a regulated output DC current. The power supply comes with an LED Power Indicator, tinned leads marked Positive (+) and Negative (-) and 2 WAGO connectors for simplified assembly.</p> <p>For more information about our 24 Volt DC Power Supply, please <a href="#">visit this webpage</a>.</p>
		<p><b>Embedded Controller Bulkhead Connector Cable - EC Configuration</b> PN: LC2-M12T-4-FX and LC5-M12T-4-FX</p> <p>This cable connects directly to the bulkhead connector on any EC configured LL330 with it's M12, 4-pos, T-Coded, female connector on one end and four flying leads on it's opposite end. The cable comes in two sizes; LC2-M12T-4-FX at 2m in length and LC5-M12T-4-FX at 5m in length. Please note this is purchased separately.</p> <p>For wiring information on this cable, please see the funtion chart above on this page.</p>
Extension Cable		<p><b>DCS-100E/103E Extension Cable, Single Light Power Cable - C1 Configuration</b> PN: LC-XX-S</p> <p>This extension cable was designed for applications requiring power cables longer than the standard 2 meters provided with Ai lights. This single light cable features a single male and single female 7 pin locking connector (C1) and can be purchased in 3 - 15 meter lengths.</p> <p>For more information about our DCS-100E/103E Extension Cable, Single Output, please <a href="#">visit this webpage</a>.</p>
		<p><b>DCS-100E/103E Extension Cable, Dual Light Power Cable - C1 Configuration</b> PN: LC-XX-Y</p> <p>This extension cable was designed for applications requiring two identical lights to be powered through a single controller. These Y cables feature a single male and dual female 7 pin locking connectors (C1) and can be purchased in 3 - 15 meter lengths. See attached spec sheet for compatible light configuration.</p> <p>For more information about our DCS-100E/103E Extension Cable, Split Output, please <a href="#">visit this webpage</a>.</p>

### Additional Information

#### Warranty

Every Advanced illumination, Inc. (Ai) product is thoroughly inspected and tested before leaving the factory. Products are warranted to be free of defects in workmanship and materials for a period of FIVE YEARS from the original date of purchase. Should a defect develop during this period, customers may return the complete product, freight prepaid, to one of Ai's distributors or to the Ai factory. All product warranty returns require a Return Merchandise Authorization (RMA) number which is obtained from Customer Service. The RMA number must be clearly marked on the outside of the package. Ai will inspect the unit, and if a defect is found will, at our option, repair or replace the product without charge. Ai disclaims liability for any implied warranties, including implied warranties of "merchantability" and "fitness for a specific purpose." For products under warranty that have since been discontinued, Ai will make an effort to replace with equivalent parts; for circumstances that do not allow for equivalent replacement, Ai reserves the right to repair or replace these products with an updated version. Ai cannot be held responsible for the unauthorized or inappropriate use of its products. Any unauthorized repair or modifications will result in a voided warranty. No Liability for Consequential Damages: In no event shall Ai be liable for any consequential, special, incidental, or indirect damages of any kind arising from the sale or use of the products.

#### Compliance

Our lighting products are designed and tested to meet CE, RoHS, and IEC standards. As a global ISO 9001 certified company, we understand the importance of compliance and perform accelerated testing on every product before shipment. For more information on our compliance standards, please see our compliancy documentation here: <https://www.advancedillumination.com/services/compliance-statements/>

#### Electromagnetic Compatibility

This product was tested and complies with the regulatory requirements and limits for electromagnetic compatibility (EMC) as stated in the product specifications. These requirements and limits are designed to provide reasonable protection against harmful interference only when the product is operated in its intended industrial electromagnetic environment. To minimize the potential for electromagnetic interference or unacceptable performance degradation, install and use this product in strict accordance with the instructions in the product documentation.

#### Customer Service

For information on existing orders, or to make an order adjustment, contact us Monday through Friday 8:00 am to 5:00 pm ET or send an email to [orders@advancedillumination.com](mailto:orders@advancedillumination.com).

#### Company Information

Advanced Illumination  
440 State Garage Road, Rochester, VT 05767  
Phone: +1 (802) 767 3830  
Fax: +1 (802) 767 2636  
Email: [info@advancedillumination.com](mailto:info@advancedillumination.com)  
Web: [advancedillumination.com](http://advancedillumination.com)  
© 2023 Advanced illumination Inc. All rights reserved