

TCCXQ066-G

Telecentric assembly with coaxial illumination for 2/3" detectors, magnification 0.66x, green

SPECIFICATIONS

Optical specifications

Magnification	(x)	0.660
Image circle Ø	(mm)	11
Phase adjustment		
Object distance	(mm)	82.8

Object field of view

with 1/3" detector (4.8 x 3.6 mm)	(mm x mm)	7.27 x 5.45
with 1/2" detector (6.4 x 4.8 mm)	(mm x mm)	9.7 x 7.27
with 1/1.8" detector (7.13 x 5.37 mm)	(mm x mm)	10.80 x 8.08
with 2/3" - 5 MP detector (8.45 x 7.07 mm)	(mm x mm)	12.88 x 10.74

Electrical specifications

Light color, peak wavelength		green, 520 nm
------------------------------	--	---------------

Device power ratings

DC voltage (min)	(V)	12
DC voltage (max)	(V)	24
Power consumption	(W)	< 2.5
Max LED fwd current 1	(mA)	350

LED power ratings

Forward voltage (typical) 2	(V)	3.3
Forward voltage (max) 2	(V)	4.00
Max pulse current 3	(mA)	2000

Dimensions

Mount		C
Length	(mm)	155.0
Height	(mm)	64
Width	(mm)	207.8
Mass	(g)	1034

Eye safety

Risk group according to CEI EN 62471:2010		Risk group 1
---	--	--------------

NOTES

- Used in continuous (not pulsed) mode.
- At max forward current. Tolerance is ±0.06V on forward voltage measurements.
- At pulse width ≤ 10 ms, duty cycle ≤ 10% condition. Built-in electronics board must be bypassed (see tech info).

COMPATIBLE PRODUCTS

Despite the efforts made to generate an error-free compatibility list, we always recommend to consult the Opto Engineering® technical support department before purchasing a compatible product. Opto Engineering® shall not be liable for any damage or malfunctioning caused by the incorrect selection of a compatible product.



LTDV series

Strobe controllers

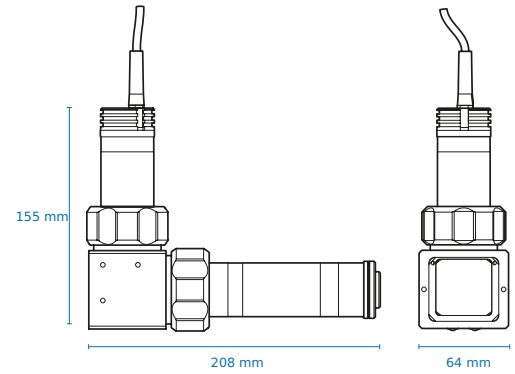

CONNECTION

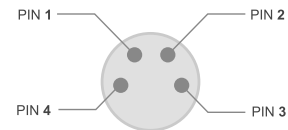

Device side - male pins
Front view

Pinout reference

Pin	Function
1	Earth
2	GND
3	LED Anode
4	Power supply (+12÷24 V)





CMHO series

Clamping mechanics

CMHO016 Clamping mechanics for TCxx016 lenses and LTCLHP016-X illuminators



LTSCHP series

High-performance replacement LED modules

LTSCHP1W-G Replacement LED module, green



PS series

Power supplies

RT-SDR-120-24 24VDC DIN rail power supply



LTIC series

Light intensity controllers

LTICOBUL1000CH1-24VUSTB 24VDC analog lighting controller 1 channel, UK power cord, Illumination cable, side A SM 3 way male connector, side B terminal blocks connector, 24V - 3m

LTICOBUL1000CH1-24VEUTB 24VDC analog lighting controller 1 channel, UK power cord, Illumination cable, side A SM 3 way male connector, side B terminal blocks connector, 24V - 3m

LTICOBUL1000CH1-24VUKTB 24VDC analog lighting controller 1 channel, UK power cord, Illumination cable, side A SM 3 way male connector, side B terminal blocks connector, 24V - 3m



COE-G series

GeniCam® PoE cameras

COE-032-M-POE-040-IR-C Area Scan camera IMX265, CMOS, Global shutter, 2048 x 1536, 3.1 MP, 3.45 pix, 1/1.8", Gray, 37.5 fps, GigE, POE, C - mount, Glass filter

COE-032-C-POE-040-IR-C Area Scan camera IMX265, CMOS, Global shutter, 2048 x 1536, 3.1 MP, 3.45 pix, 1/1.8", Color, 37.5 fps, GigE, POE, C - mount, Infrared cut filter

COE-063-M-POE-040-IR-C-B Area Scan camera IMX178, CMOS, Rolling shutter, 3072 x 2048, 6.3 MP, 2.4 pix, 1/1.8", Gray, 17 fps, GigE, POE, C - mount, Glass filter

COE-063-C-POE-040-IR-C Area Scan camera IMX178, CMOS, Rolling shutter, 3072 x 2048, 6.3 MP, 2.4 pix, 1/1.8", Color, 17 fps, GigE, POE, C - mount, Infrared cut filter

COE-122-M-POE-041-IR-C Area Scan camera IMX226, CMOS, Rolling shutter, 4024 x 3036, 12.2 MP, 1.85 pix, 1/1.7", Gray, 9.6 fps, GigE, POE, C - mount, Glass filter

COE-122-C-POE-041-IR-C Area Scan camera IMX226, CMOS, Rolling shutter, 4024 x 3036, 12.2 MP, 1.85 pix, 1/1.7", Color, 9.6 fps, GigE, POE, C - mount, Infrared cut filter

COE-023-M-POE-050-IR-C Area Scan camera PYTHON 2000, CMOS, Global shutter, 1920 x 1200, 2.3 MP, 4.8 pix, 2/3", Gray, 51 fps, GigE, POE, C - mount, Glass filter

COE-023-C-POE-050-IR-C Area Scan camera PYTHON 2000, CMOS, Global shutter, 1920 x 1200, 2.3 MP, 4.8 pix, 2/3", Color, 51 fps, GigE, POE, C - mount, Infrared cut filter

COE-050-M-POE-050-IR-C Area Scan camera IMX264, CMOS, Global shutter, 2448 x 2048, 5 MP, 3.45 pix, 2/3", Gray, 23.5 fps, GigE, POE, C - mount, Glass filter

COE-050-C-POE-050-IR-C Area Scan camera IMX264, CMOS, Global shutter, 2448 x 2048, 5 MP, 3.45 pix, 2/3", Color, 23.5 fps, GigE, POE, C - mount, Infrared cut filter



COE-U series

USB 3.0 GeniCam® cameras

COE-063-M-USB-040-IR-C Area Scan camera IMX178, CMOS, Rolling shutter, 3072 x 2048, 6.3 MP, 2.4 pix, 1/1.8", Gray, 42 fps, USB 3.0, C - mount, Glass filter

COE-063-C-USB-040-IR-C Area Scan camera IMX178, CMOS, Rolling shutter, 3072 x 2048, 6.3 MP, 2.4 pix, 1/1.8", Color, 42 fps, USB 3.0, C - mount, Infrared cut filter

COE-050-M-USB-050-IR-C Area Scan camera IMX264, CMOS, Global shutter, 2448 x 2048, 5 MP, 3.45 pix, 2/3", Gray, 35 fps, USB 3.0, C - mount, Glass filter



mvBlueFOX3-2 series

USB3 vision camera with Sony Pregius CMOS sensors

RT-mvBF3-2032a USB3 Vision camera with Sony Pregius CMOS sensor IMX265

RT-mvBF3-2032	USB3 Vision camera with Sony Pregius CMOS sensor IMX252
RT-mvBF3-2064	Usb3 vision camera with sony pregius cmos sensor imx178
RT-mvBF3-2051a	USB3 Vision camera with Sony Pregius CMOS sensor IMX264
RT-mvBF3-2051	USB3 Vision camera with Sony Pregius CMOS sensor IMX250



mvBlueCOUGAR series

GigE & Dual GigE Vision cameras

RT-mvBC-X104i	Camera with interface GigE (1GB/s), sensor size 1/1.8", mpixel 3.19, resolution 2064 x 1544, sensor name IMX265, sensor type CMOS
RT-mvBC-XD104h	Camera with interface Dual GigE (2GB/s), sensor size 1/1.8", mpixel 3.19, resolution 2064 x 1544, sensor name IMX252, sensor type CMOS
RT-mvBC-X105b	Camera with interface GigE (1GB/s), sensor size 2/3", mpixel 5.07, resolution 2464 x 2056, sensor name IMX264, sensor type CMOS
RT-mvBC-XD105a	Camera with interface Dual GigE (2GB/s), sensor size 2/3", mpixel 5.01, resolution 2448 x 2048, sensor name IMX250, sensor type CMOS



Accessories

Accessories and add-ons to make the most of Opto Engineering lenses.

RT-mvBC-X104iC	CMOS camera GIGE, 2064 x 1544 color, 1/1.8", 37 Hz, IR cut, C-mount, I/O
RT-mvBC-X105bC	CMOS camera GIGE, 2464 x 2056 Colour sensor, 2/3", 23.5 Hz, IR cut, C-mount, I/O