

TCCX350-W

Coaxial telecentric lens for 2/3" detectors, WD 132.3 mm, magnification 3.50x, white

SPECIFICATIONS

Magnification	(x)	3.500
Image circle Ø	(mm)	11
Phase adjustment		Yes

Object field of view (8)

with 1/3" detector (4.8 x 3.6 mm)	(mm x mm)	1.37 x 1.03
with 1/2.5" detector (5.70 x 4.28 mm)	(mm x mm)	1.63 x 1.22
with 1/2" detector (6.4 x 4.8 mm)	(mm x mm)	1.83 x 1.37
with 1/1.8" detector (7.13 x 5.37 mm) (7)	(mm x mm)	2.04 x 1.53
with 2/3" - 5 MP detector (8.45 x 7.07 mm)	(mm x mm)	2.43 x 2.03

Optical specifications

Working distance (1)	(mm)	132.3
wF/# (2)		24
Telecentricity typical (max) (3)	(deg)	0.04 (0.06)
Distortion typical (max) (4)	(%)	0.05 (0.10)
Field depth (5)	(mm)	0.2
CTF @ 35 lp/mm	(%)	> 30

Electrical specifications

Light color, peak wavelength	(nm)	white
------------------------------	------	-------

Device power ratings

DC voltage minimum	(V)	12
DC voltage maximum	(V)	24
Power consumption	(W)	< 2.5
Max LED forward current (7)	(mA)	350

LED power ratings

Forward voltage (typical) (8)	(V)	2.78
Forward voltage (max) (8)	(V)	-
Max pulse current (9)	(mA)	2000

Dimensions

Mount		C
Length (6)	(mm)	181.5
Diameter	(mm)	37.7
Mass	(g)	596

Eye safety

Risk group according to CEI EN 62471:2010		Risk group 1
---	--	--------------

NOTES

- Working distance: distance between the front end of the mechanics and the object. Set this distance within +/- 3% of the nominal value for maximum resolution and minimum distortion.
- Working F/#: the real F/# of a lens when used as a macro. Lenses with smaller apertures can be supplied on request.
- Maximum slope of chief rays inside the lens: when converted to milliradians, it gives the maximum measurement error for any millimeter of object displacement. Typical (average production) values and maximum (guaranteed) values are listed.
- Percent deviation of the real image compared to an ideal, undistorted image: typical (average production) values and maximum (guaranteed) values are listed.
- At the borders of the field depth the image can be still used for measurement but, to get a perfectly sharp image, only half of the nominal field depth should be considered. Pixel size used for calculation is

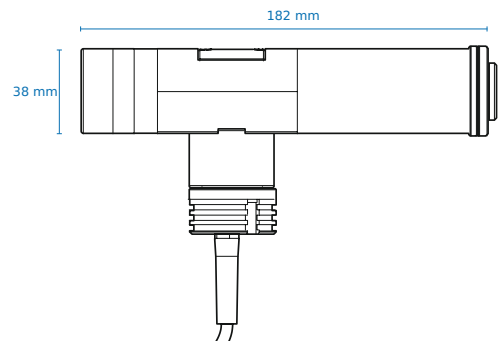

CONNECTION

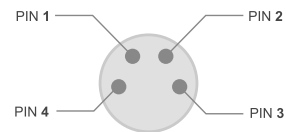

Device side - male pins
Front view

Pinout reference

Pin	Function
1	Earth
2	GND
3	LED Anode
4	Power supply (+12÷24 V)



5.5 µm.

6. Measured from the front end of the mechanics to the camera flange.
7. Used in continuous (not pulsed) mode.
8. At max forward current. Tolerance is ±0.06V on forward voltage measurements.
9. At pulse width ≤ 10 ms, duty cycle ≤ 10% condition. Built-in electronics board must be bypassed (see tech info).

COMPATIBLE PRODUCTS

Despite the efforts made to generate an error-free compatibility list, we always recommend to consult the Opto Engineering® technical support department before purchasing a compatible product. Opto Engineering® shall not be liable for any damage or malfunctioning caused by the incorrect selection of a compatible product.



LTDMC series

Continuous LED domes

LT4WRG150-00-1-W-24V	LED dome light, 185 mm outer diameter, white, 24V
LT4WRG150-00-1-R-24V	LED dome light, 185 mm outer diameter, red, 24V
LT4WRG150-00-1-G-24V	LED dome light, 185 mm outer diameter, green, 24V
LT4WRG150-00-1-B-24V	LED dome light, 185 mm outer diameter, blue, 24V



LTLAIC series (discontinued models)

Continuous LED low angle diffused ringlights

LT2RZF070-60-2-W-24V	LED ringlight, 2 LED rows, 76.2 mm outer diameter, 60°, white, 24V
LT2RZF070-60-2-R-24V	LED ringlight, 2 LED rows, 76.2 mm outer diameter, 60°, red, 24V
LT2RZF070-60-2-G-24V	LED ringlight, 2 LED rows, 76.2 mm outer diameter, 60°, green, 24V
LT2RZF070-60-2-B-24V	LED ringlight, 2 LED rows, 76.2 mm outer diameter, 60°, blue, 24V



LTLAIC series

Continuous LED low angle diffused ringlights

LT3RZF080-60-1-W-24V	LED ringlight, 1 LED row, 81 mm outer diameter, 60°, white, 24V
LT3RZF080-60-1-R-24V	LED ringlight, 1 LED row, 81 mm outer diameter, 60°, red, 24V
LT3RZF080-60-1-G-24V	LED ringlight, 1 LED row, 81 mm outer diameter, 60°, green, 24V
LT3RZF080-60-1-B-24V	LED ringlight, 1 LED row, 81 mm outer diameter, 60°, blue, 24V



LTLADC series

Continuous LED low angle direct ringlights

LTZZO130-75-3-W-24V	LED low angle ringlight, 3 LED rows, outer diameter 131 mm, 75°, white, 24V
LTZZO130-75-3-R-24V	LED low angle ringlight, 3 LED rows, outer diameter 131 mm, 75°, red, 24V
LTZZO130-75-3-G-24V	LED low angle ringlight, 3 LED rows, outer diameter 131 mm, 75°, green, 24V
LTZZO130-75-3-B-24V	LED low angle ringlight, 3 LED rows, outer diameter 131 mm, 75°, blue, 24V



LTRNDC series

Continuous LED direct ringlights

LTZGK050-15-2-W-24V	LED ringlight, 2 LED rows, outer diameter 50 mm, 15°, white, 24V
LTZGK050-15-2-R-24V	LED ringlight, 2 LED rows, outer diameter 50 mm, 15°, red, 24V
LTZGK050-15-2-G-24V	LED ringlight, 2 LED rows, outer diameter 50 mm, 15°, green, 24V
LTZGK050-15-2-B-24V	LED ringlight, 2 LED rows, outer diameter 50 mm, 15°, blue, 24V



LTDV series

Strobe controllers

LTDV1CH-17V	Strobe controller 1 channel variable current 5 mA - 17A
-----------------------------	---



LTBFC series

Continuous flat side-emitting LED backlights

LTPVRG25X36-00-1-W-24V	Flat side-emitting LED backlight, thin borders, 25X36 mm illumination area, white, 24V
LTPVRG25X36-00-1-R-24V	Flat side-emitting LED backlight, thin borders, 25X36 mm illumination area, red, 24V
LTPVRG25X36-00-1-G-24V	Flat side-emitting LED backlight, thin borders, 25X36 mm illumination area, green, 24V
LTPVRG25X36-00-1-B-24V	Flat side-emitting LED backlight, thin borders, 25X36 mm illumination area, blue, 24V



LTBRDC series

Continuous LED bar lights

LTZPFL040-00-6-W-24V	LED bar light, 6 LED rows, 40X26.3 illumination area, white, 24V
LTZPFL040-00-6-R-24V	LED bar light, 6 LED rows, 40X26.3 illumination area, red, 24V
LTZPFL040-00-6-G-24V	LED bar light, 6 LED rows, 40X26.3 illumination area, green, 24V
LTZPFL040-00-6-B-24V	LED bar light, 6 LED rows, 40X26.3 illumination area, blue, 24V



LTSCHP series

High-performance replacement LED modules

LTSCHP1W-W	Replacement LED module, white
----------------------------	-------------------------------



CB series

Cables

CB244P1500	Power cable, side 1 M8 connector straight, side 2 cable end - 2 m - type 1 labels
CB244P1500L	Power cable, side 1 M8 connector angled, side 2 cable end - 2 m - type 1 labels



PS series

Power supplies

RT-SDR-120-24	24VDC DIN rail power supply
-------------------------------	-----------------------------



LTIC series

Light intensity controllers

LTICOBUL1000CH1-24VUSTB	24VDC analog lighting controller 1 channel, UK power cord, Illumination cable, side A SM 3 way male connector, side B terminal blocks connector, 24V - 3m
LTICOBUL1000CH1-24VEUTB	24VDC analog lighting controller 1 channel, UK power cord, Illumination cable, side A SM 3 way male connector, side B terminal blocks connector, 24V - 3m
LTICOBUL1000CH1-24VUKTB	24VDC analog lighting controller 1 channel, UK power cord, Illumination cable, side A SM 3 way male connector, side B terminal blocks connector, 24V - 3m



COE-G series

GenICam® PoE cameras

COE-032-M-POE-040-IR-C	Area Scan camera IMX265, CMOS, Global shutter, 2048 x 1536, 3.1 MP, 3.45 pix, 1/1.8", Gray, 37.5 fps, GigE, POE, C - mount, Glass filter
COE-032-C-POE-040-IR-C	Area Scan camera IMX265, CMOS, Global shutter, 2048 x 1536, 3.1 MP, 3.45 pix, 1/1.8", Color, 37.5 fps, GigE, POE, C - mount, Infrared cut filter
COE-063-M-POE-040-IR-C-B	Area Scan camera IMX178, CMOS, Rolling shutter, 3072 x 2048, 6.3 MP, 2.4 pix, 1/1.8", Gray, 17 fps, GigE, POE, C - mount, Glass filter
COE-063-C-POE-040-IR-C	Area Scan camera IMX178, CMOS, Rolling shutter, 3072 x 2048, 6.3 MP, 2.4 pix, 1/1.8", Color, 17 fps, GigE, POE, C - mount, Infrared cut filter
COE-122-M-POE-041-IR-C	Area Scan camera IMX226, CMOS, Rolling shutter, 4024 x 3036, 12.2 MP, 1.85 pix, 1/1.7", Gray, 9.6 fps, GigE, POE, C - mount, Glass filter
COE-122-C-POE-041-IR-C	Area Scan camera IMX226, CMOS, Rolling shutter, 4024 x 3036, 12.2 MP, 1.85 pix, 1/1.7", Color, 9.6 fps, GigE, POE, C - mount, Infrared cut filter
COE-023-M-POE-050-IR-C	Area Scan camera PYTHON 2000, CMOS, Global shutter, 1920 x 1200, 2.3 MP, 4.8 pix, 2/3", Gray, 51 fps, GigE, POE, C - mount, Glass filter
COE-023-C-POE-050-IR-C	Area Scan camera PYTHON 2000, CMOS, Global shutter, 1920 x 1200, 2.3 MP, 4.8 pix, 2/3", Color, 51 fps, GigE, POE, C - mount, Infrared cut filter

[COE-050-M-POE-050-IR-C](#) Area Scan camera IMX264, CMOS, Global shutter, 2448 x 2048, 5 MP, 3.45 pix, 2/3", Gray, 23.5 fps, GigE, POE, C - mount, Glass filter

[COE-050-C-POE-050-IR-C](#) Area Scan camera IMX264, CMOS, Global shutter, 2448 x 2048, 5 MP, 3.45 pix, 2/3", Color, 23.5 fps, GigE, POE, C - mount, Infrared cut filter

 COE-U series

USB 3.0 GenICam® cameras

[COE-063-M-USB-040-IR-C](#) Area Scan camera IMX178, CMOS, Rolling shutter, 3072 x 2048, 6.3 MP, 2.4 pix, 1/1.8", Gray, 42 fps, USB 3.0, C - mount, Glass filter

[COE-063-C-USB-040-IR-C](#) Area Scan camera IMX178, CMOS, Rolling shutter, 3072 x 2048, 6.3 MP, 2.4 pix, 1/1.8", Color, 42 fps, USB 3.0, C - mount, Infrared cut filter

[COE-050-M-USB-050-IR-C](#) Area Scan camera IMX264, CMOS, Global shutter, 2448 x 2048, 5 MP, 3.45 pix, 2/3", Gray, 35 fps, USB 3.0, C - mount, Glass filter



mvBlueFOX3-2 series

USB3 vision camera with Sony Pregius CMOS sensors

[RT-mvBF3-2032a](#) USB3 Vision camera with Sony Pregius CMOS sensor IMX265

[RT-mvBF3-2032](#) USB3 Vision camera with Sony Pregius CMOS sensor IMX252

[RT-mvBF3-2064](#) Usb3 vision camera with sony pregius cmos sensor imx178

[RT-mvBF3-2051a](#) USB3 Vision camera with Sony Pregius CMOS sensor IMX264

[RT-mvBF3-2051](#) USB3 Vision camera with Sony Pregius CMOS sensor IMX250



mvBlueCOUGAR series

GigE & Dual GigE Vision cameras

[RT-mvBC-X104i](#) Camera with interface GigE (1GB/s), sensor size 1/1.8", mpixel 3.19, resolution 2064 x 1544, sensor name IMX265, sensor type CMOS

[RT-mvBC-XD104h](#) Camera with interface Dual GigE (2GB/s), sensor size 1/1.8", mpixel 3.19, resolution 2064 x 1544, sensor name IMX252, sensor type CMOS

[RT-mvBC-X105b](#) Camera with interface GigE (1GB/s), sensor size 2/3", mpixel 5.07, resolution 2464 x 2056, sensor name IMX264, sensor type CMOS

[RT-mvBC-XD105a](#) Camera with interface Dual GigE (2GB/s), sensor size 2/3", mpixel 5.01, resolution 2448 x 2048, sensor name IMX250, sensor type CMOS



Accessories

Accessories and add-ons to make the most of Opto Engineering lenses.

[RT-mvBC-X104iC](#) CMOS camera GIGE, 2064 x 1544 color, 1/1.8", 37 Hz, IR cut, C-mount, I/O

[RT-mvBC-X105bC](#) CMOS camera GIGE, 2464 x 2056 Colour sensor, 2/3", 23.5 Hz, IR cut, C-mount, I/O